

**Prof. Dr. Rainer Renkawitz**

Genetisches Institut

Fachbereich 08

(Fachrichtung Biologie)

Justus-Liebig-Universität Giessen

Giessen, Germany

**Prof. Dr. Alberto Muñoz Terol**

Instituto de Investigaciones Biomédicas

Consejo Superior de Investigaciones

Científicas (CSIC)

Universidad Autónoma de Madrid

Madrid, Spain

# **Characterization of Alien isoforms in vertebrates**

(Charakterisierung von Alien Isoformen in Vertebraten)

(Caracterización de isoformas de Alien en vertebrados)

## **Inaugural-Dissertation**

zur Erlangung des akademischen Grades eines  
Doktors der Naturwissenschaften (Dr. rer. nat.)  
vorgelegt dem Fachbereich 08 (Fachrichtung Biologie)  
der Justus-Liebig-Universität Giessen

von

**Stephan Tenbaum**

Madrid 2002

**Dekan / Dean:**

**Prof. Dr. Jürgen Janek**

Justus-Liebig-Universität, Giessen, Germany

**1. Gutachter / 1<sup>st</sup> Referee: Prof. Dr. Rainer Renkawitz**

Genetisches Institut der Justus-Liebig-Universität, Giessen, Germany

**2. Gutachter / 2<sup>nd</sup> Referee: Prof. Dr. Alberto Muñoz Terol**

Instituto de Investigaciones Biomédicas, CSIC,  
Universidad Autónoma de Madrid, Madrid, Spain

*To my parents, Nuria and  
Elisabeth Tenbaum (\*1899-†2002)*

**Part of this work is published in:**

Altincicek, B.\*, **Tenbaum, S. P.\***, Dressel, U.\*, Thormeyer, D., Renkawitz, R., and Baniahmad, A. (2000). Interaction of the corepressor Alien with DAX-1 is abrogated by mutations of DAX-1 involved in adrenal hypoplasia congenita.

*J Biol Chem* **275**, 7662-7.

(\* equally contributed)

**Tenbaum, S. P.**, Juenemann, S., Schlitt, T., Bernal, J., Renkawitz, R., Muñoz, A., and Baniahmad, A. (submitted). Alien/CSN2 gene expression is regulated by thyroid hormone in rat brain.

**This work has been financed by grants to S. Tenbaum from:**

- Private funding of Irene Tenbaum, Dr. med Arnold Tenbaum and Nuria Oliveira Gomez
- The german exchange program of the Deutscher Akademischer Austauschdienst (DAAD)
- The "Programa de Acciones Especiales y Acciones de Política Científica" (Reference: APC1999-0172)"
- The spanish-german exchange program (1999-2000)"Accion integrada" of the Spanish Ministry for Education and Culture "Regulation of nuclear hormone receptors by transcriptional corepressors" (Reference: HA 1998-0082)

## Publication list

**Stephan Tenbaum** and Aria Baniahmad

Review: “Nuclear Receptors: Structure, Function and Involvement in Disease”

*Int. Journal of Biochemistry and Cell Biology*, 1997 Dec; 29(12): 1325-41

Thormeyer, D.; **Tenbaum, S.**; Renkawitz, R. and Baniahmad, A.

“EcR Interacts with Co-repressors and Harbours an Autonomous Silencing Domain Functional in both *Drosophila* and Vertebrate Cells.”

*J. of Steroid Biochemistry and Molecular Biology*, 1999 Feb; 68(3-4):163-9

Dressel, U., Thormeyer, D., Altincicek, B., Paululat, A., Eggert, M.; Schneider, S., **Tenbaum, S.**, Renkawitz, R., and Baniahmad, A.

“Alien: a Highly Conserved Protein with Characteristics of a Corepressor for Nuclear Hormone Receptors.”

*Molecular and Cellular Biology*, 1999 May; 19(5):3383-94

Altincicek, B.\*; **Tenbaum, S.\***; Dressel, U.\*; Thormeyer, D.; Renkawitz, R., and Baniahmad, A.

“Interaction of the Corepressor Alien with DAX-1 is Abrogated by Mutations of DAX1 Involved in Adrenal Hypoplasia Congenita.”

*Journal of Biological Chemistry*, 2000 Mar 17; 275(11):7662-7

(\* equally contributed)

Arozarena, I.; Aaronson, D. S.; Matallanas, D.; Sanz, V.; Ajenjo, N.; **Tenbaum, S.**; Teramoto, H.; Ighishi, T.; Zabala, C.; Gutkind, J. S. and Crespo, P.

“The Rho Family GTPase Cdc42 Regulates the Activation of Ras / MAP Kinase by the Exchange Factor Ras-GRF.”

*Journal of Biological Chemistry*, 2000 Aug 25; 275(34):26441-8.

## Contents

	Publication list	I
	Abbreviations	VI
<b>1.</b>	<b>Summary</b>	<b>1</b>
	Ausführliche Zusammenfassung	2
	Resumen	8
<b>2.</b>	<b>Introduction</b>	<b>11</b>
2.1	The thyroid hormone receptor	11
2.2	Corepressors of the thyroid hormone receptor	13
<b>3.</b>	<b>Objective</b>	<b>18</b>
<b>4.</b>	<b>Material and Methods</b>	<b>19</b>
<b>4.1</b>	<b>Material</b>	<b>19</b>
4.1.1	Equipment	19
4.1.2	General chemicals	20
4.1.3	Consumables	22
4.1.4	Kits and columns	23
4.1.5	Radioactive chemicals	23
4.1.6	Enzymes	23
4.1.7	Antibiotics	23
4.1.8	Antibodies	24
4.1.9	Stimuli, inhibitors, hormones, anesthetics, substrates	24
4.1.10	DNA, RNA and protein molecular weight markers	25
4.1.11	Informatics	25
4.1.12	Bacterial strains	25
4.1.13	Yeast strain	26
4.1.14	Eukaryotic cell lines	26
4.1.15	Animals	28
4.1.16	Provided plasmids	28
<b>4.2</b>	<b>Methods</b>	<b>30</b>
4.2.1	Preparations	30
4.2.2	Growth and storage of bacteria	30
4.2.3	Production of competent bacteria	30
4.2.4	Transformation of bacteria	31
4.2.5	Expression and purification of recombinant proteins in bacteria	31
4.2.6	Manipulation of DNA	31
4.2.7	Manipulation of RNA	34
4.2.8	Manipulation of proteins	35
4.2.9	Eukaryotic cell culture	44
4.2.10	<i>In situ</i> hybridization	49

4.2.11	Manipulation of yeast	50
<b>5.</b>	<b>Results</b>	<b>53</b>
<b>5.1</b>	<b>Plasmid construction</b>	<b>54</b>
5.1.1	Remark	54
5.1.2	Mammalian expression and <i>in vitro</i> transcription vectors	54
5.1.3	Yeast expression vectors	58
<b>5.2</b>	<b>Studies on Alien expression</b>	<b>63</b>
5.2.1	Alien mRNA expression levels vary between different rat tissues	63
5.2.2	Multiple proteins are detectable with the Alien antibody in different rat tissues	64
5.2.3	Alien mRNAs are ubiquitously present in the rat brain and their expression pattern is suggestive to be predominant neuronal	66
5.2.4	Alien mRNA expression is regulated by T3 during rat brain development	68
5.2.5	Alien mRNA is generally down regulated in the hypothyroid rat brain at postnatal day 5 – Expression levels are normalized at postnatal day 15.	69
5.2.6	Alien mRNA expression is severely reduced in the hypothyroid rat cerebellum.	71
5.2.7	Alien mRNAs are induced by T3 treatment in TR expressing N2A neuroblastoma cells	72
5.2.8	Alien mRNAs are induced in confluent N2A-TR $\alpha$ and N2A-TR $\beta$ cells in hormone free conditions.	74
5.2.9	Alien mRNAs are expressed and regulated by T3 in glial cells.	77
5.2.10	Both, actinomycin-D and cycloheximide prevent T3-mediated Alien gene expression in N2A-TR $\beta$ cells	77
5.2.11	Alien protein is induced by thyroid hormone <i>in vivo</i> and in TR expressing cells	79
<b>5.3</b>	<b>Functional characterization of Alien<math>\alpha</math> and Alien<math>\beta</math> isoforms</b>	<b>81</b>
5.3.1	Both Alien $\alpha$ and Alien $\beta$ silence transcription when tethered to DNA.	81
5.3.2	Both GST-Alien $\alpha$ and GST-Alien $\beta$ interact with <i>in vitro</i> -translated hTR $\beta$ -ct in GST-pulldown	83
5.3.3	Alien $\alpha$ as well as Alien $\beta$ stimulates AP1 mediated transcription in a dose dependent manner in HeLa cells	84
5.3.4	Alien $\alpha$ interacts with hRb through its N-terminus in the yeast-two-hybrid system	85
5.3.5	The N-termini of both, Alien $\alpha$ and Alien $\beta$ , are required for interaction with hRb in the yeast-two-hybrid system – mutation of the hRb pocket domain abolishes these interactions	86
5.3.6	The entire small pocket domain of hRb is necessary for interaction with Alien $\beta$ in yeast, as shown for Alien $\alpha$	88
5.3.7	Both Alien $\alpha$ and Alien $\beta$ interact with <i>in vitro</i> -translated hRb in GST-pulldown	89
5.3.8	GST-hRb <sub>379-928</sub> interacts with both Alien $\alpha$ and Alien $\beta$ <i>in vitro</i>	89

5.3.9	Alien $\beta$ , but not Alien $\alpha$ , influences hRb-mediated transcriptional activation	90
5.3.10	Alien $\beta$ abolishes Rb-mediated superactivation of Sp1-driven transcription – The Rb-mutant C706F is not able to super-activate Sp1	93
5.3.11	Sp1 interacts directly with Rb in GST-pulldown – Alien $\beta$ interferes with this interaction	96
5.3.12	Both Alien $\alpha$ and Alien $\beta$ interact with <i>in vitro</i> -translated E2F1 in GST-pulldown.	98
5.3.13	Alien $\alpha$ represses transcriptional activation mediated by an E2F-LUC reporter construct in absence of functional Rb in C33A cells.	99
5.3.14	Protein expression of Alien $\alpha$ and Alien $\beta$ during cell cycle	101
<b>5.4</b>	<b>Phosphorylation of Alien<math>\alpha</math> and Alien<math>\beta</math> proteins</b>	<b>104</b>
5.4.1	Relationship between domains and functions of hAlien $\beta$ and the prediction of phosphorylation sites	104
5.4.2	Both Alien $\alpha$ and Alien $\beta$ are phospho-proteins <i>in vivo</i> in HEK293 cells	106
5.4.3	Alien $\alpha$ and Alien $\beta$ bind to a kinase activity present in extracts of HEK293 cells	107
5.4.4	Neither recombinant Alien $\alpha$ nor Alien $\beta$ exhibit autophosphorylation activity	109
5.4.5	Alien $\beta$ is phosphorylated by at least two kinases of approximately 42 kDa and 35 kDa present in total extracts of HEK293 cells	109
5.4.6	Alien $\alpha$ and Alien $\beta$ are not phosphorylated by classic members of the MAPK family of protein kinases	110
5.4.7	Alien $\alpha$ and Alien $\beta$ are not phosphorylated by ERK isoforms <i>in vitro</i> .	112
5.4.8	Alien $\alpha$ and Alien $\beta$ are not substrate for p38-MAP-kinases <i>in vitro</i> .	113
5.4.9	Alien $\alpha$ and Alien $\beta$ are not phosphorylated by JNK <i>in vitro</i>	113
5.4.10	Alien $\alpha$ , but not Alien $\beta$ , is substrate for MLK2 <i>in vitro</i>	114
5.4.11	Alien $\alpha$ and Alien $\beta$ are substrates for p34cdc2	116
<b>5.5</b>	<b>Summary of the results comparing features of Alien<math>\alpha</math> and Alien<math>\beta</math>.</b>	<b>120</b>
<b>6.</b>	<b>Discussion</b>	<b>121</b>
<b>6.1</b>	<b>Studies on Alien mRNA and protein expression suggest tissue-specific functions and post-transcriptional regulatory mechanisms</b>	<b>121</b>
6.1.2	The expression of alien mRNAs varies within different rat tissues	121
6.1.3	A tissue-specific alien mRNA and a putative novel Alien protein isoform suggest additional functions of Alien in rat adrenal gland	123
<b>6.2</b>	<b>Regulation of Alien expression by thyroid hormone</b>	<b>124</b>
<b>6.3</b>	<b>Comparison of Alien<math>\alpha</math> and Alien<math>\beta</math></b>	<b>126</b>
6.3.1	Alien $\beta$ silences gene activation similar to Alien $\alpha$	126
6.3.2	Both Alien $\alpha$ and Alien $\beta$ stimulate AP1-driven transcription	127



---

<b>6.4</b>	<b>The identification of novel Alien-interacting factors and studies on non-hormonal regulation suggest possible roles of Alien isoforms in cell cycle regulation</b>	<b>129</b>
6.4.1	Alien $\alpha$ and Alien $\beta$ interact with important cell cycle regulators	129
6.4.2	Alien $\beta$ interferes with the Rb-Sp1 pathway	131
6.4.3	Induction of Alien expression in confluent cells	133
6.4.4	Both Alien isoforms are phospho-proteins <i>in vivo</i> and interact with kinases	134
6.4.5	Alien $\alpha$ and Alien $\beta$ are substrates for the cyclin-dependent kinase p34cdc2	135
<b>6.5</b>	<b>Outlook</b>	<b>137</b>
<b>6.6</b>	<b>Appendix</b>	<b>139</b>
<b>7.</b>	<b>Bibliography</b>	<b>141</b>
	Eidesstattliche Erklärung (Statutory declaration)	155
	Curriculum	156
	Acknowledgements	157

## Abbreviations

For the abbreviations of amino acids the one- or three letter code (IUPAC) was used.

aa	amino acids
Act-D	actinomycin-D
Amp	ampicillin
APS	ammoniumpersulfate
ATP	adenosin triphosphate
$\beta$ -gal	$\beta$ -galactosidase
B42	B42 activation domain
bp	base pair(s)
BSA	bovine serum albumin
C	control
CAMKII	calcium-calmodulin-dependent kinase type II
CHX	cycloheximide
CIAP	calf intestine alkaline phosphatase
CMV	cytomegalovirus
CNS	central nervous system
Col	collagenase
CSN	COP9-signalosome
Cy	cyclophilin
Cyc	cyclin
DBD	DNA binding domain
ddNTPs	di- desoxy nucleotides (ddATP, ddCTP, ddGTP, ddTTP)
DMEM	Dulbecco's Modified Essential Medium
DMSO	dimethylsulfoxid
DNA	desoxy ribonucleic acid
dNTPs	desoxy nucleotides (dATP, dCTP, dGTP, dTTP)
DTT	dithiothreitol
E19	embryonal day 19
EDTA	ethylendiamine tetraacetate
ERK	extra cellular regulated kinase
FCS	fetal calf serum
GST	glutathion-S-transferase
HA	hemaglutinine
HCl	Hydrochloric acid
hEGF	human epithelial growth factor
HRP	horse radish peroxidase
Hypo	hypothyroid
IPTG	isopropyl- $\beta$ -D-thiogalactopyranoside
JNK	jun-N-terminal kinase
Kan	kanamycin
kb	kilo base pairs
kDa	kilo Dalton
Lex	LexA-DBD
LUC	luciferase
MAPK	mitogen activated protein kinase
MAPKKK	mitogen activated protein kinase kinase kinase
MBP	myelin basic protein

---

MLK2	mixed lineage kinase 2
MMI	2-mercapto-1-methyl-imidazole
mRNA	messenger RNA
NCoR	nuclear receptor corepressor
NP-40	nonidet P-40
Nucleotides	A = adenosin, C = cytosin, T = thymidin, G = guanosin
OD	optical density
o/n	over night
ONPG	orto-nitrophenyl galactoside
P0	day of birth
P5	post natal day 5 (analogously: P10, P15)
PBS	phosphate buffered saline
PCR	polymerase chain reaction
PEG	polyethylen glycol
PIPES	Piperazine-N,N'-bis (2-ethanesulfonic acid)
PMSF	phenylmethylsulfonyl fluoride
Rb	retinoblastoma protein
Rb-P	retinoblastoma pocket domain
RNA	ribonucleic acid
rpm	rounds per minute
RT	room temperature
RTH	resistance to thyroid hormone syndrome
SAP	shrimp alkaline phosphatase
SDS	sodium dodecylsulfate
SMRT	silencing mediator of retinoic acid and thyroid hormone receptor
ssDNA	salmon sperm DNA
SV40	simian virus 40
T3	triiodothyronine
T4	thyroxin
TCA	trichloro acetic acid
TBE	Tris/borate/EDTA
TNF $\alpha$	tumor necrosis factor alpha
TNT-System	<i>in vitro</i> -translated using TNT-T7 Quick Transcription/Translation (Promega)
TPA	phorbol ester
TR	thyroid hormone receptor
TRE	thyroid hormone response element
TRIP	thyroid hormone receptor interacting protein
UAS	upstream activating sequence (DNA binding sequence of Gal4)
UTP	uracil triphosphate
UTR	untranslated region
UV	ultra violet light
VDR	vitamin-D3 receptor
VDRE	vitamin-D3 response element
X-Gal	5-bromo-4-chloro-3-indoyl- $\beta$ -D-galactopyranoside

## 1. Summary

Alien protein isoforms have been described to be involved in a number of biological processes. Alien $\alpha$  is a corepressor of the thyroid hormone receptor mediating transcriptional repression in a ligand-sensitive manner. Furthermore, Alien $\alpha$  is a corepressor for the orphan receptor DAX1 and the vitamin-D3 receptor. Alien $\beta$ /CSN2 is part of the COP9-signalosome complex that acts in protein phosphorylation, protein degradation and cell cycle regulation.

The major goal of this work was to characterize the Alien $\alpha$  and Alien $\beta$  isoforms. Little was known about their expression pattern and the regulation of their expression had not been addressed.

It was determined in this work that the expression pattern of Alien is rather ubiquitous in rat tissues. Interestingly, a putative novel Alien protein isoform and an additional alien messenger specific for adrenal gland were identified. Furthermore, it was shown *in vivo* and *in vitro*, by *in situ* hybridization, Northern and Western blotting that Alien expression is regulated by thyroid hormone in the rat brain and brain-derived cell lines. Subsequently, hints for a second T3-independent mechanism of regulation of Alien expression depending on cell confluence or quiescence were discovered.

The comparison of Alien isoforms in functional aspects identified Rb and E2F as novel Alien-interacting proteins with similar binding characteristics *in vitro* and in yeast but functional differences *in vivo*. Alien $\beta$  interfered with Rb-mediated superactivation of Sp1-driven transcription, whereas Alien $\alpha$  exerted strong repression on E2F transactivation. Common traits for both Alien $\alpha$  and Alien $\beta$  are their silencing potential, interaction with TR and activation of AP1-driven transcription.

Phosphorylation studies raised the possibility of regulation by non-hormonal signaling since Alien $\alpha$  and Alien $\beta$  are phosphorylated *in vivo*. *In gel* kinase assays suggested the existence of two different Alien-phosphorylating kinases. Further experiments identified MLK2 and the cell cycle kinase p34cdc2 as such kinases, suggesting a possible function of Alien in cell cycle regulation.

Taken together, the expression of Alien is regulated by thyroid hormone, and by cell density; the isoforms can be phosphorylated and can act either as transcriptional repressors or as activators. Additional data indicate a role of Alien isoforms in cell cycle regulation through p34cdc2 phosphorylation and isoform-specific interference with Rb and E2F.

## Ausführliche Zusammenfassung

Diese Arbeit beschreibt die Charakterisierung der Proteine der Alien Familie, die in verschiedenste biologische Prozesse involviert sind. Die Alien Isoform Alien $\alpha$  (305 Aminosäuren) wurde als hormonsensitiver Corepressor für den Thyroidhormon Rezeptor beschrieben (Dressel *et al.*, 1999).

Der Thyroidhormon Rezeptor (TR; Isoformen TR $\alpha$  und TR $\beta$ ) ist Mitglied der Kernhormon Rezeptor Familie (Mangelsdorf *et al.*, 1995). Kernhormon Rezeptoren spielen Schlüsselrollen in Entwicklungsprozessen, Differenzierung und Stoffwechsel. Der TR ist ein bifunktionaler Transkriptionsfaktor, der an TR-spezifische DNA Bindestellen (TREs; "*TR response elements*") in Promotoren von Zielgenen bindet (Dressel and Baniahmad, 2000). Die transkriptionelle Regulation durch den TR wird hormonabhängig durch Cofaktoren, den Corepressoren und Coaktivatoren, vermittelt.

In Abwesenheit seines Liganden, des Thyroidhormons (T3, Triiodothyronin und des molekularen Vorläufers T4, Thyroxin - im Folgenden T3 genannt), wird die Expression dieser Zielgene durch TR gehemmt ("*Silencing*"). Diese Repression wird durch Corepressorkomplexe vermittelt, die mit Chromatin kondensierenden Histondeacetylasen (HDAC) interagieren oder direkt in hemmenden Kontakt zur basalen Transkriptionsmaschinerie treten (McKenna and O'Malley, 2000; Wolffe *et al.*, 2000a; Rosenfeld and Glass, 2001; Ordentlich *et al.*, 2001). In Anwesenheit des Liganden vollzieht der TR eine Konformationsänderung die zur Ablösung der Corepressoren führt an deren Stelle dann Coaktivatoren gebunden werden. Der Liganden-gebundene TR, in Verbindung mit Coaktivatoren, aktiviert nun die Expression der Zielgene. Mutationen in TR-Genen, unphysiologische Niveaus von Thyroidhormon, sowie abnorme Interaktion des TR mit seinen Corepressoren kann zur Ausbildung von schweren Krankheitsbildern (*Thyroidhormon Resistenz, Hypothyroidismus*) führen (Übersichtsartikel: Tenbaum and Baniahmad, 1997; Bernal, 2002; Burke and Baniahmad, 2000).

Corepressoren sind nicht DNA-bindende Faktoren, die Repression von *Silencer*-Proteinen vermitteln. Für den Thyroidhormon Rezeptor sind ausser Alien $\alpha$  die Corepressoren SMRT (Chen and Evans, 1995), NCoR (Horlein *et al.*, 1995), Hairless (Potter, 2001 #85) und SUN-CoR (Zamir *et al.*, 1997) beschrieben. Diese bisher bekannten Corepressoren reprimieren die Genaktivität einerseits über die Rekrutierung

von Histondeacetylasen (HDAC), andererseits interagieren sie auch mit basalen Transkriptionsfaktoren (Übersichtsartikel: Burke and Baniahmad, 2000).

Es konnte ebenfalls gezeigt werden, dass Alien $\alpha$  mit dem Orphan-Rezeptor DAX1 (Altincicek *et al.*, 2000), sowie mit dem Rezeptor für Vitamin-D3 (VDR; Polly *et al.*, 2000) interagiert und in ähnlicher Weise, wie für den TR bewiesen, reprimierend auf die transkriptionellen Eigenschaften dieser Rezeptoren wirkt. DAX1 ist für die sexspezifische Genexpression in verschiedenen Geweben wie Nebennieren, Gonaden, Hypophyse und Hypothalamus verantwortlich (Übersichtsartikel: Tenbaum and Baniahmad, 1997; Goodfellow and Camerino, 2001; Achermann *et al.*, 2001). Mutationen in DAX1 beeinflussen in erheblicher Weise die Entwicklung und Differenzierung in diesen Geweben und führen zu Krankheiten wie dem *hypogonadotrophen Hypogonadismus* und der *adrenalen Hypoplasie* (Übersichtsartikel: Tenbaum and Baniahmad, 1997). Alien $\alpha$  interagiert mit der Wildtyp Form des DAX1 Rezeptors nicht aber mit mutierten Formen, die in Patienten mit diesen ebengenanten Krankheiten vorkommen (Altincicek *et al.*, 2000). Der Vitamin-D3 Rezeptor ist an wichtigen physiologischen Prozessen wie der Regulation des Kalzium Stoffwechsels, der zellulären Differenzierung und Proliferation beteiligt (Carlberg, 1995; Kato, 2000). Die Interaktion von Alien $\alpha$  mit dem VDR ist auf Promotoren eines limitierten Sets von VDR Zielgenen mit speziellen DNA Bindestellen vom Typ DR3 beschränkt (Polly *et al.*, 2000).

Eine weitere Isoform von Alien, nämlich Alien $\beta$  (444 Aminosäuren), wurde als Untereinheit eines multifunktionellen, evolutionär hochkonservierten Proteinkomplexes, des COP9-Signalosoms (CSN, Deng *et al.*, 2000), identifiziert. Das CSN wurde ursprünglich als ein Regulator der lichtabhängigen Signaltransduktion in Pflanzen gefunden (Chamovitz *et al.*, 1996). Dieser Proteinkomplex und seine Untereinheiten sind in Säugern in eine Vielzahl von zellulären Mechanismen, wie z.B. die Regulation von Protein Kinase Kaskaden und Protein Degradation sowie des Zell Zykluses, involviert (Übersichtsartikel: Wei and Deng, 1999; Seeger *et al.*, 2001; Schwechheimer and Deng, 2001a; Kim *et al.*, 2001; Chamovitz and Glickman, 2002).

Ziel dieser Arbeit war es die Proteine der Alien Familie, Alien $\alpha$  und Alien $\beta$ , weiter zu charakterisieren. Trotz der Zahl an wissenschaftlichen Veröffentlichungen über die Isoformen von Alien war bisher sehr wenig über ihre Expressionsmuster bekannt.

Mechanismen, die die Expression von Alien Proteinen regulieren könnten, sind bisher nicht beschrieben.

Deshalb wurde zunächst das generelle Expressionsmuster von Alien mRNA und Proteinen in verschiedenen Ratten Geweben bestimmt.

Hierbei wurden die beiden erwarteten Signale der Proteine Alien $\alpha$  (ca. 40 kDa) und Alien $\beta$  (ca. 54 kDa) gefunden. Jedoch variieren die relativen Mengen dieser Proteine zueinander in verschiedenen Gewebetypen, sodass angenommen werden kann, dass beide Protein-Isoformen verschiedenen, evtl. zelltypspezifischen regulatorischen Mechanismen unterliegen. Interessanterweise konnte in Nebennieren der Ratte neben Alien $\alpha$  und Alien $\beta$  eine mögliche neue Alien Isoform mit einem molekularen Gewicht von ca. 28 kDa entdeckt werden. Das lässt den Verdacht zu, dass Alien in diesem Gewebe spezielle Funktionen hat. Das wird dadurch verstärkt, dass in Nebennieren DAX1, dessen Corepressor Alien $\alpha$  ist (Altincicek *et al.*, 2000), gewebespezifisch exprimiert wird. Interessanterweise wurde auf RNA Ebene neben den erwarteten Alien mRNA Signalen ebenfalls eine zusätzliche Alien RNA von ca. 6 kb identifiziert. Ob diese 6 kb mRNA für die Translation der möglichen neuen 28 kDa Alien Isoform zuständig ist, kann nicht ohne weiteres aus diesen Daten geschlossen werden.

In allen anderen untersuchten Geweben waren die bereits bekannten alien mRNA Signale von ca. 2 kb und ca. 4 kb prädominant. Wie schon bei der Protein Expression beobachtet, variierte auch hier der Gehalt der beiden alien mRNAs in verschiedenen Organen, was auf die Existenz von posttranskriptionalen Mechanismen, wie zum Beispiel der Regulation der Stabilität der mRNA, hindeuten könnte. In Übereinstimmung mit dieser Hypothese konnten in den alien mRNAs einige Sequenzmotive identifiziert werden (AUUUA-Motive, ARE's; Guhaniyogi and Brewer, 2001; Rodriguez-Pascual *et al.*, 2000; Staton *et al.*, 2000), die mit Steuerungsmechanismen der mRNA Stabilität in Verbindung gebracht werden.

Die Alien Expression wurde weiterhin *in vivo* und *in vitro* mittels *in situ* Hybridisierung, Northern und Western blot untersucht. Dies führte zu der wichtigen Entdeckung, dass die Expression von alien mRNA und Proteinen im Rattenhirn durch Thyroidhormon reguliert wird. Die alien mRNAs werden in allen Regionen des Rattenhirns exprimiert, scheinen jedoch bevorzugt in neuronalen Geweben und weniger in Glia vorzukommen. Diese generelle Expression ist mit der des TR zu vereinen, welcher ebenfalls in allen Teilen des Gehirns vorkommt (Bradley *et al.*, 1992; Ferreiro

*et al.*, 1990; Mellstrom *et al.*, 1991). Ferner konnte gezeigt werden, dass die Expression der alien mRNAs während der Gehirnentwicklung von hypothyroiden Ratten zeitweise extrem reduziert ist. Dies konnte in Zellkultur bestätigt werden. Diese hormonsensitive Reduzierung von Alien, die auf die Zeitspanne um die Geburt beschränkt ist, könnte zu der abnormen Funktion des TR in Gehirn von hypothyroiden Säugetieren beitragen. Es könnte sich hierbei aber auch um einen kompensatorischen Mechanismus handeln, bei dem der Organismus die durch das fehlende Hormon verstärkte Zielgenrepression auszugleichen sucht.

Die Regulation eines Corepressors des TR durch T3 in Gehirn wurde bereits für den Corepressor Hairless beschrieben (Thompson, 1996; Potter *et al.*, 2001). Die Entdeckung eines ähnlichen Steuerungsmechanismus für Alien lässt auf ein allgemeineres Prinzip der Corepressorfunktion für TR schließen.

Andere Resultate dieser Arbeit, die Regulation der Alien Expression betreffend, zeigten einen weiteren Mechanismus, bei dem die alien mRNAs abhängig von der Zelldichte von kultivierten N2A Neuroblastomazellen anstieg. Dies könnte mit Zellkontaktmechanismen oder mit dem Eintreten der Zellen in die quieszente Zell-Zyklusphase (G0) zusammenhängen.

Ein weiteres Ziel dieser Arbeit war es, Alien $\alpha$  und Alien $\beta$  funktionell auf Gemeinsamkeiten und Unterschiede zu vergleichen und neue Alien Interaktionspartner zu finden.

Es konnten hier zwei Proteine identifiziert werden, die jeweils mit Alien $\alpha$  und Alien $\beta$  interagieren. Die Bindungseigenschaften dieser beiden Proteine, des Retinoblastoma Tumorsuppressors (Rb) und des Zell Zyklus Regulators E2F (Übersichtsartikel: Harbour and Dean, 2000a), waren *in vitro* und z.T. in Hefe-Interaktionsstudien untereinander vergleichbar. Transkriptionelle Funktionsstudien in eukariotischen Zelllinien brachten jedoch Unterschiede zu Tage. Im Gegensatz zu Alien $\alpha$ , war Alien $\beta$  *in vivo* in der Lage mit der Rb vermittelten "Superaktivierung" der vom Transkriptionsfaktor SP1 abhängigen Transaktivierung zu interferieren. Im Falle der Interaktion mit E2F zeigte sich ein gegenteiliges Bild. Die transkriptionsaktivierende Funktion von E2F wurde effizient von Alien $\alpha$  gehemmt, während Alien $\beta$  in diesem Zusammenhang kaum Effekte zeigte. Es existieren also funktionelle Unterschiede zwischen Alien $\alpha$  und Alien $\beta$  *in vivo*.



Resultate anderer Experimente brachten jedoch auch funktionelle Gemeinsamkeiten zwischen Alien $\alpha$  und Alien $\beta$  hervor. Beide Isoformen von Alien sind in der Lage mit dem Thyroidhormon Rezeptor zu interagieren. Ferner aktivieren Alien $\alpha$  und Alien $\beta$  in gleichem Masse AP1 vermittelte Transaktivierung.

Um festzustellen ob Alien-Isoformen neben der Regulation ihrer Funktion durch T3 eventuell auch durch andere Signaltransduktionskaskaden reguliert werden könnten, wurden beide Proteine auf Modifikation durch Phosphorylierung untersucht. Es war bereits bekannt, dass Alien $\beta$  im Kontext des Signalosoms von einer noch unbekanntem Kinaseaktivität phosphoryliert wird (Seeger *et al.*, 1998). Dies konnte durch Phosphorylierungsexperimente *in vivo* bestätigt werden. Außerdem konnte dabei zum ersten Mal gezeigt werden, dass auch Alien $\alpha$  in der Zelle als Phosphoprotein vorliegt. Weiterführende Untersuchungen wurden mit Hilfe von "*in Gel*"-Kinaseassays durchgeführt. Diese Experimente sollten über Zahl und molekulares Gewicht der Kinasen, die an der Alien-Phosphorylierung beteiligt sind, Aufschluss geben. Es konnte demonstriert werden, dass mindestens zwei Kinasen mit molekularen Massen von ca. 35 kDa und ca. 42 kDa Substratspezifität zumindest für Alien $\beta$  aufweisen. Ferner konnte gezeigt werden, dass die Mitosis-induzierende Zell-Zyklus-Kinase p34cdc2 (Übersichtsartikel: John *et al.*, 2001) beide Isoformen von Alien phosphoryliert. Interessanterweise hat p34cdc2 ein molekulares Gewicht von 34 kDa und ist somit ein Kandidat für eine der vermuteten Alien-Kinasen.

In der Arbeitsgruppe von Dr. A. Baniahmad konnte gezeigt werden, dass Alien $\alpha$  mit einer MAPKKK, "*mixed-lineage kinase 2*" (MLK2; Dorow *et al.*, 1995) genannt, interagiert (Eckey, unpublizierte Daten). In dieser Arbeit wurde demonstriert, dass MLK2 ebenfalls in der Lage ist, Alien $\alpha$  zu phosphorylieren. Die exakte Rolle dieser aufgezeigten posttranskriptionalen Modifikationen an Alien Proteinen muss noch weiter untersucht werden.

Zusammenfassend kann gesagt werden, dass Alien $\alpha$  und Alien $\beta$  deutliche funktionelle Unterschiede aufweisen, aber auch funktionelle Gemeinsamkeiten haben. Als wichtiges Ergebnis ist die Identifizierung der Regulation der Alien-Expression durch T3 in zentralnervösen Geweben der Ratte, als erster bekannter Alien Regulationsmechanismus, hervorzuheben. Es könnte sich hierbei um einen negativen Rückkopplungsmechanismus zwischen dem TR und seinem eigenen Corepressor handeln.

Ferner weisen die Interaktionen von Alien $\alpha$  und Alien $\beta$  mit wichtigen Zell-Zyklus-Regulatoren, wie Rb, E2F und der Mitose-Kinase p34cdc2, auf eine funktionelle Beteiligung an Zell-Zyklus-Prozessen hin. Diese Vermutung wird dadurch bestätigt, dass die Expression von Alien in hormonunabhängiger Weise durch Zell-Zell-Kontakt oder im Zusammenhang mit der G0 Zell-Zyklus-Phase induziert wird. Diese Hypothese steht in Übereinstimmung mit wissenschaftlichen Berichten, die Alien $\beta$  im Kontext des CSN mit einer negativen Regulierung des Zell-Zyklus in der G1/S Phase assoziieren (Yang *et al.*, 2002). Ein positiver Einfluss des CSN auf die Passage durch die S/G2 Phase wurde ebenfalls beschrieben (Mahalingam *et al.*, 1998; Mundt *et al.*, 1999).

Es sind viele weitere Untersuchungen nötig, um die genaueren Aufgaben von Alien $\alpha$  und Alien $\beta$  in den verschiedenen beschriebenen zellulären Prozessen weiter aufzuklären.

## Resúmen

Las proteínas de la familia Alien participan en diversos procesos biológicos. La isoforma Alien $\alpha$  ha sido caracterizada como un co-represor del receptor de la hormona tiroidea (TR; Dressel *et al.*, 1999). En ausencia de su ligando, la hormona tiroidea (T3), Alien $\alpha$  interacciona con el TR, transmitiendo su potencial represor mediante el reclutamiento, por una parte, de deacetilasas de histonas (HDAC) y por otra, de la maquinaria basal de transcripción (Dressel y Möhren resultados sin publicar). De forma similar, Alien $\alpha$  está implicada en la represión génica del receptor huérfano DAX1 y del receptor de la vitamina-D3 (Altincicek *et al.*, 2000; Polly *et al.*, 2000). La isoforma Alien $\beta$  fue descrita como una subunidad de un complejo proteico multifuncional denominado COP9-signalosoma (CSN; revisiones: Wei and Deng, 1999; Seeger *et al.*, 2001; Schwechheimer and Deng, 2001a; Kim *et al.*, 2001; Chamovitz and Glickman, 2002). Este complejo desempeña papeles importantes en procesos celulares como la fosforilación, la degradación de proteínas y la regulación del ciclo celular.

El objetivo general de este trabajo ha sido la caracterización detallada de las dos proteínas Alien $\alpha$  y Alien $\beta$ .

Aunque en la literatura se han descrito distintas funciones de las diferentes isoformas de Alien, hasta la fecha poco se sabía de su patrón de expresión. Además los mecanismos que regulan la expresión y la función de Alien $\alpha$  y Alien $\beta$  nunca han sido investigados.

En este trabajo, se ha determinado en primer lugar el patrón general de expresión del ARNm y de las isoformas de Alien en diferentes tejidos de rata. Se ha identificado una posible nueva isoforma de Alien, con un peso molecular de aproximadamente 28 kDa cuya expresión parece estar restringida a las glándulas adrenales. Se ha detectado asimismo una forma adicional de ARNm de un tamaño aproximado de 6 kb en este mismo tejido. Esto podría significar que determinadas isoformas de Alien poseen funciones específicas en las glándulas adrenales. Adicionalmente, estos resultados sugieren la existencia de mecanismos de regulación post-transcripcional ("*splicing*", estabilidad de mensajeros), de la expresión de Alien.

El estudio de la expresión de Alien tanto *in vitro*, (en células de neuroblastoma N2A), como *in vivo*, (en cerebro de rata), utilizando las técnicas de hibridación *in situ*, Northern y Western blot, ha revelado que tanto el ARNm como las distintas isoformas

de proteína Alien están bajo el control de la hormona tiroidea. Se puede concluir que la T3 es capaz de inducir la expresión de Alien en cultivos de células N2A que expresan el receptor de esta hormona e *in vivo* en el cerebro de rata. Dada su función como co-represor del receptor de T3, la regulación de su expresión por esta hormona podría provocar parte de las anomalías en el funcionamiento de TR que se observan en el cerebro hipotiroideo o bien podría ser un mecanismo compensatorio del organismo. Estos datos están en consonancia con el hecho de que otro co-represor del TR, la proteína Hairless, también está regulada por T3 en cerebro de rata (Thompson, 1996; Potter *et al.*, 2001). Adicionalmente se ha encontrado un mecanismo de regulación de Alien que es independiente de T3. Los ARNm de Alien se inducen en función de la confluencia de los cultivos celulares. Esto podría estar relacionado con mecanismos provocados por contactos celulares o con la entrada de las células en un estado de quiescencia.

Otro de los objetivos de este trabajo era la comparación funcional de las proteínas Alien $\alpha$  y Alien $\beta$ .

Se podían identificar dos nuevas interacciones proteicas con Alien $\alpha$  y Alien $\beta$ . Estas proteínas son el represor de tumores retinoblastoma (Rb) y el factor de transcripción E2F, ambos importantes reguladores del ciclo celular (Harbour and Dean, 2000a). Las características de las interacciones entre Alien $\alpha$  y Alien $\beta$  con Rb y E2F han sido investigadas tanto en levaduras como *in vitro* mediante "*GST-Pulldown*" y son muy similares en ambos casos. Curiosamente, las especificidades de unión frente a Rb y E2F parecen ser distintas entre las dos isoformas de Alien *in vivo* en células de mamífero: mientras que Alien $\beta$  interfiere con la hiper-activación por Rb de la función activadora del factor de transcripción Sp1, Alien $\alpha$  no tiene efectos significativos en este sistema. En el caso de la interacción con E2F, Alien $\beta$  carece de actividad, mientras que Alien $\alpha$  es capaz de reprimir fuertemente la activación de la transcripción por E2F. Esto demuestra que existen diferencias en las funciones de Alien $\alpha$  y Alien $\beta$  *in vivo*.

Adicionalmente otros estudios han revelado que existen también similitudes en las funciones de Alien $\alpha$  y Alien $\beta$  en sistemas celulares. El potencial de represión génica de ambas proteínas es comparable y ambas isoformas son capaces de interactuar con el receptor de T3. Además, las dos isoformas activan de forma similar al factor de transcripción AP1.

Otro de los objetivos ha sido el estudio de la fosforilación de las isoformas de las proteínas Alien. Se ha descrito que Alien $\beta$  está fosforilada en el contexto del CSN (Seeger *et al.*, 1998). La identificación de la cascada de quinasas responsable de esta fosforilación constituye un nuevo nivel de regulación de las funciones de las proteínas Alien independiente de hormona tiroidea.

Se ha visto que Alien $\alpha$  y Alien $\beta$  están fosforiladas *in vivo*. Mediante ensayos quinasa *in gel* se ha detectado la acción de al menos dos quinasas diferentes con un peso molecular de 35 y 42 kDa, respectivamente. Experimentos adicionales han permitido identificar la quinasa p34cdc2, responsable de la iniciación de la mitosis, como una quinasa capaz de fosforilar a ambas isoformas de Alien *in vitro*. Adicionalmente se ha demostrado mediante ensayos quinasa *in vitro* que la quinasa MLK2, una MAPKKK que interactúa con Alien $\alpha$  (Eckey, resultados sin publicar), fosforila específicamente a Alien $\alpha$  pero no a Alien $\beta$ .

En definitiva, con este trabajo se ha demostrado que Alien $\alpha$  y Alien $\beta$  comparten algunas características funcionales y difieren claramente en otras.

El descubrimiento de la regulación de la expresión de Alien por hormona tiroidea supone un dato importante ya que es el primer mecanismo de regulación de expresión de genes de la familia Alien descrito y podría representar un mecanismo de regulación de "feedback" negativo entre el TR y su propio co-represor.

La interacción e interferencia funcional de Alien $\alpha$  y Alien $\beta$  con importantes reguladores del ciclo celular como Rb, E2F o la quinasa p34cdc2, inductora de mitosis, sugiere una posible función de Alien en la regulación del ciclo celular. El que la expresión de Alien esté inducida por contacto celular o la entrada de las células en estado quiescente también sugiere la participación de Alien en este proceso. Esta hipótesis está de acuerdo con estudios recientes que relacionan Alien $\beta$  en el contexto del signalosoma con un papel regulador negativo en la transición de la fase G1 del ciclo celular a la fase S (Yang *et al.*, 2002). Adicionalmente se ha discutido una influencia positiva de Alien en la fase S/G2 (Mahalingam *et al.*, 1998; Mundt *et al.*, 1999). Serán necesarios estudios adicionales para definir de modo más preciso el papel de Alien $\alpha$  y Alien $\beta$  en estos procesos celulares.

## 2. Introduction

The investigation of regulation mechanisms of gene expression in higher eukaryotes has a central role in understanding how genomic information is translated to promote orchestrated cellular functions in a cell type, tissue or developmental state-specific manner. The identification of multiple transcription factors, regulatory elements in promoter regions of many genes and the characterization of signaling pathways permitted to get insight into the complex regulatory networks of differential gene expression. Cells exerting special roles within a multi-cellular organism require specific gene expression programs turning on necessary genes or switching off needless ones. These gene expression programs are established or modified upon cellular stimuli such as among others growth factors, cytokines and hormones merging down on transcriptional activities of transcription factor complexes.

### 2.1 The thyroid hormone receptor

An example for well studied transcription factors sensitive to hormonal stimuli combining both silencing and activation of target genes, are the thyroid hormone receptors (TR $\alpha$  and TR $\beta$  isoforms; here referred to as TR). The TR is a member of the nuclear hormone receptor super family of transcription factors (NHRs; Mangelsdorf *et al.*, 1995) that control key processes in development, differentiation and homeostasis. TR regulates transcription acting in concert with coregulator complexes (McKenna and O'Malley, 2000; Wolffe *et al.*, 2000a; Rosenfeld and Glass, 2001; Ordentlich *et al.*, 2001). In absence of its ligand - thyroid hormone - (T3 - triiodothyronine and its precursor thyroxin, T4) the thyroid hormone receptor silences expression of target genes with TR binding sites (TREs, TR response elements; Dressel and Baniahmad, 2000). This repression is mediated at least in part by corepressor complexes (Baniahmad *et al.*, 1993; Baniahmad *et al.*, 1992; Baniahmad *et al.*, 1995; Horlein *et al.*, 1995; Chen and Evans, 1995; Dressel *et al.*, 1999; Li *et al.*, 1999). Binding of T3 to TR provokes conformational changes in the receptor leading to dissociation of corepressors and subsequent recruitment of coactivator complexes activating transcription of target genes (Baniahmad *et al.*, 1995; Baniahmad *et al.*, 1997; Wolffe *et al.*, 2000b).

Mutations of TR, aberrant levels of thyroid hormone and abnormal interaction of TR with its corepressors can lead to severe pathophysiological manifestations (reviewed in Tenbaum and Baniahmad, 1997; Burke and Baniahmad, 2000; Bernal, 2002).

Increased stability of corepressor/TR complexes is implicated in the human syndrome of *thyroid hormone resistance* (RTH; Tenbaum and Baniahmad, 1997). RTH displays a mostly dominantly genetically inherited disorder based on mutations of the TR $\beta$  gene. The main characteristic of RTH is the lack or reduction of response to thyroid hormone of target tissues. The main clinical indications are elevated levels of plasma thyroid hormones and inappropriate thyrotropin levels. As symptoms goiter, attention deficit, learning disabilities, and hearing defects, impaired bone maturation and mental retardation were observed. Furthermore, speech impediment, frequent ear, nose, and throat infections have been described. Most of these symptoms show that TR and its corepressors play a very important role in brain development.

Due to the reduced rate of corepressor release from TR in presence of T3 in the RTH-syndrome some of the described symptoms are similar to those observed during hypothyroidism another TR-related disorder.

Thyroid hormone action is essential for mammalian brain maturation (Legrand, 1984; Dussault and Ruel, 1987; Porterfield and Hendrich, 1993). Lack of adequate levels of thyroid hormones during fetal and neonatal periods lead to multiple brain abnormalities and mental retardation in humans (Legrand, 1984; DeLong, 1990). Conditions like *iodine deficiency*, *congenital hypothyroidism*, *maternal hypothyroxinemia* and *prematurity* diminish physiological levels of thyroid hormone and may compromise brain maturation. Crucial processes in mammalian brain development, such as axogenesis and dendritic arborization, myelination, lamination of the cerebral cortex as well as neuronal cell migration are affected by hypothyroidism and result in structural abnormalities of the central nervous system (reviewed in: Bernal and Nunez, 1995; Bernal, 2002). In the last years a number of genes have been identified, to be under the direct or indirect control of thyroid hormone in the brain (Muñoz *et al.*, 1991; Brent, 1994; Oppenheimer and Schwartz, 1997; Cuadrado *et al.*, 1999; Bernal, 2002). Deregulation of these TR target genes may in part explain the symptoms of hypothyroidism in brain.

## 2.2 Corepressors of the thyroid hormone receptor

Corepressor complexes are major determinants of cell-specific gene expression because their relative cellular abundance governs the extent of transcriptional repression of target genes by TR in absence of hormone (reviewed in Burke and Baniahmad, 2000). Although a large number of coactivators for thyroid hormone receptors have been described (Aranda and Pascual, 2001; Dilworth and Chambon, 2001; Lee *et al.*, 2001; Hermanson *et al.*, 2002), only a limited number of classes of corepressors for TR classified by molecular homologies are identified.

### NCoR/SMRT

One class consists in the homologous corepressors NCoR (Nuclear receptor corepressor; Horlein *et al.*, 1995) and SMRT (silencing mediator of retinoid acid and thyroid hormone receptors, Chen and Evans, 1995) and its relatives (Hermanson *et al.*, 2002). Both types of corepressors interact with TR and RAR (retinoid acid receptor) in a hormone sensitive fashion and mediate silencing at least in part through Sin3-containing histone deacetylase complexes (HDACs; Alland *et al.*, 1997; Heinzl *et al.*, 1997; Nagy *et al.*, 1997) that condense chromatin and thereby repress transcription (Laherty *et al.*, 1997). Furthermore, it has been suggested that NCoR and SMRT get in touch with the basal transcription machinery to mediate repression (Muscat *et al.*, 1998). The NCoR/SMRT class of corepressors is not specific for nuclear hormone receptors and also participates in silencing by other transcriptional silencers such as e.g. MyoD, PLZF and BCL6 (reviewed in Burke and Baniahmad, 2000). NCoR and SMRT play roles in biological processes such as cell differentiation (Bailey *et al.*, 1999) and neoplastic transformation (Gelmetti *et al.*, 1998; Lutterbach *et al.*, 1998).

### SUN-CoR

A second class of corepressors for TR is the small unique nuclear receptor corepressor (SUN-CoR; Zamir *et al.*, 1997) that shows no homologies to the NCoR/SMRT class of corepressors. SUN-CoR is able to intensify TR-mediated silencing due to its autonomous silencing domain, although the interaction with TR is not sensitive to thyroid hormone. This corepressor has been suggested to be an additional component of receptor/corepressor complexes.



### Hairless

Mutations in the gene product of the hairless gene has been known for a long time to be associated to congenital hair disorders such as *alopecia universalis* and *papular atrichia* in mouse and human (Brooke, 1926; Ahmad *et al.*, 1998; Cichon *et al.*, 1998). Recently, the wild type Hairless (Hr) protein was found to interact with and be corepressor of thyroid hormone and retinoid acid receptors (Thompson and Bottcher, 1997; Potter *et al.*, 2001). Hr shares little homology to previously described corepressors and is referred to as a third class of nuclear hormone receptor corepressors presenting the common corepressor characteristics (reviewed in Burke and Baniahmad, 2000). Similar to the other classes of TR corepressors, Hr mediates transcriptional repression via HDAC-complexes (Potter *et al.*, 2001). Differently to ubiquitously present NCoR/SMRT corepressors (Horlein *et al.*, 1995; Chen and Evans, 1995), Hr expression is largely restricted to skin and brain (Cachon-Gonzalez *et al.*, 1994; Thompson, 1996). In the rat brain its expression is temporally restricted to the first three postnatal weeks coinciding with maximal neuronal differentiation (Ferreiro *et al.*, 1990; Mellstrom *et al.*, 1991; Bradley *et al.*, 1992). Hairless is therefore an example for a spatially and developmental state-specific corepressor of the thyroid hormone receptor.

Interestingly, expression of the Hairless corepressor has been shown to be under the control of thyroid hormone in the developing rat brain and its expression is severely affected by hypothyroidism (Thompson, 1996). Accordingly, deregulation of Hr expression, due to lack of thyroid hormone, or by the presence of mutations in the hairless gene manifests in alterations of the neuronal morphology and inner ear defects (Cachon-Gonzalez *et al.*, 1994; Thompson, 1996; and refs therein).

### Alien

A fourth class of corepressors for TR comprises the evolutionary highly-conserved Alien proteins that show no sequence similarities to the before-mentioned corepressors. Human Alien $\alpha$  is a protein composed of 305 amino acids that is highly homologous (90% identity, 95% similarity) to the *Drosophila* Alien protein (Goubeaud *et al.*, 1996; Dressel *et al.*, 1999). Alien $\alpha$  was initially isolated as thyroid hormone receptor (TR)-interacting protein (TRIP15 = partial clone of Alien $\alpha$ ; Lee *et al.*, 1995). Later it was shown that full length Alien $\alpha$  acts as a corepressor mediating silencing of thyroid hormone receptor (Dressel *et al.*, 1999). Thereby, Alien $\alpha$  interacts with TR in absence

of thyroid hormone and thus mediates TR silencing in a hormone dependent manner. In presence of thyroid hormone the Alien $\alpha$  corepressor is released from TR. Interestingly, Alien $\alpha$  does not interact with RAR as shown for most of the other above mentioned classes of TR corepressors. *Drosophila* Alien (dAlien; 360 amino acids, Goubeaud *et al.*, 1996) acts as corepressor for the ecdysone receptor that is critical for insect metamorphic processes (Dressel *et al.*, 1999).

The mechanism underlying the transcriptional repression mediated by Alien $\alpha$  is based on its intrinsic silencing function, partly consisting - similarly to the other classes of corepressors - in recruiting Sin3-containing histone deacetylase complexes (HDACs) to TR (Dressel *et al.*, 1999). In addition, Alien $\alpha$  represses transcription independently from HDAC-function presumably by interference with basal transcription factors (Dressel *et al.*, 1999; Dressel and Moehren unpublished data).

Recently, the interference of Alien $\alpha$  with transcriptional activity of other transcription factors such as the orphan receptor DAX1 (Altincicek *et al.*, 2000) and the nuclear receptor for vitamin-D<sub>3</sub> (VDR; Polly *et al.*, 2000) has been shown.

The orphan receptor DAX1 is member of the nuclear hormone receptor super family (Mangelsdorf *et al.*, 1995). Mutations in the DAX-1 gene cause the X-linked disorder of *adrenal hypoplasia congenita* and the associated *hypogonadotropic hypogonadism* (reviewed in Tenbaum and Baniahmad, 1997; Goodfellow and Camerino, 2001; Achermann *et al.*, 2001). DAX1 is predominantly expressed in adrenal gland and testis, where DAX1 mutations strongly affect the development and differentiation of these tissues (Zanaria *et al.*, 1994). Expression of DAX1 has also been reported in hypothalamus, pituitary and human skin (Guo *et al.*, 1995; Patel *et al.*, 2001). It has been shown that DAX1 interferes with steroidogenesis in adrenal cells by inhibiting the expression of steroidogenic acute regulatory protein (Zazopoulos *et al.*, 1997). Furthermore, DAX1 inhibits the activation function of orphan nuclear receptor SF-1 and ligand dependent activation by the androgen receptor, which are involved in sex-specific gene expression (Ito *et al.*, 1997; Nachtigal *et al.*, 1998; Swain *et al.*, 1998; Holter *et al.*, 2002). One mechanism by which DAX1 inhibits gene expression is through a potent silencing domain localized in the C-terminus (Ito *et al.*, 1997; Lalli *et al.*, 1997; Crawford *et al.*, 1998). Interestingly, most of the DAX1 mutations found in patients with *adrenal hypoplasia congenita* have the common feature of an altered C-terminus (Muscatelli *et al.*, 1994). N-CoR was shown to interact with DAX1 (Crawford

*et al.*, 1998), while a lack of corepressor squelching using RAR indicates that there are additional corepressors involved in DAX1-mediated silencing (Lalli *et al.*, 1997). In fact, it could be demonstrated that Alien $\alpha$  binds DAX1 and thus is a candidate corepressor. In line with that, DAX1-mutants that have lost silencing ability also lack binding of the Alien $\alpha$  corepressor (Altincicek *et al.*, 2000). Therefore, the functional interaction of restrictedly expressed DAX1 with Alien $\alpha$  is another example for tissue specific receptor/corepressor crosstalk.

The VDR (vitamin-D<sub>3</sub> receptor) is a nuclear hormone receptor that mediates transcriptional target gene expression in response to its physiological ligand 1,25-dihydroxyvitamin-D<sub>3</sub> (Carlberg, 1995; Kato, 2000). The vitamin-D<sub>3</sub> receptor plays important roles in calcium homeostasis, cell proliferation and differentiation and in line with that, mutations in the VDR gene lead to multiple human disorders including cancer, immune dysfunction, endocrine disorders, and metabolic bone diseases. (reviewed in Tenbaum and Baniahmad, 1997; Hansen *et al.*, 2001). Transcriptional repression of VDR target genes is mediated by the NCoR/SMRT and the Alien class of corepressors (Dwivedi *et al.*, 1998; Tagami *et al.*, 1998; Polly *et al.*, 2000; Rosenfeld and Glass, 2001). Interestingly, Alien seems to bind VDR with a higher affinity than NCoR/SMRT but the Alien $\alpha$ /VDR partnership has been shown to be dependent on the nature of the respective VDR DNA binding sequence (VDRE, VDR response element; Polly *et al.*, 2000). Thus, Alien $\alpha$ -transmitted repression is restricted to VDR target genes regulated by DR3-type VDREs. These findings represent another mechanism where receptor/corepressor crosstalk is limited, in this case to a confined set of target genes.

Intriguingly, an Alien isoform, Alien $\beta$ /CSN2 (**C**OP9-**s**ignalosome subunit **2**; Deng *et al.*, 2000) with 444 amino acids, has been shown to be a subunit of an evolutionary conserved multimeric protein complex called COP9-signalosome (CSN; Wei and Deng, 1999; Henke *et al.*, 1999; Schwechheimer and Deng, 2001a; Chamovitz and Glickman, 2002). The CSN is composed of eight subunits numbered CSN1-8 according to their molecular weight (Deng *et al.*, 2000) and was initially identified as a regulator of light-mediated signal transduction in plants (Chamovitz *et al.*, 1996). Alien $\beta$ /CSN2 (here referred to as Alien $\beta$ ) is identical to Alien $\alpha$  in the first 305 amino acids encompassing the whole Alien $\alpha$  protein. The differing C-terminus of Alien $\beta$  consists in a structural

domain called PCI domain (Hofmann and Bucher, 1998; Kim *et al.*, 2001) responsible for integration into the CSN (Freilich *et al.*, 1999). Studies on subunit interaction within the CSN revealed that Alien $\beta$  interacts with at least five of the eight CSN subunits (Kapelari *et al.*, 2000; Fu *et al.*, 2001; Kim *et al.*, 2001) and overexpression of Alien $\beta$  leads to *de novo* formation of the complex, suggesting that Alien $\beta$  is an essential core unit (Naumann *et al.*, 1999). The CSN and its subunits are involved in multiple cellular processes including protein kinase pathways, protein degradation mechanisms and cell cycle regulation (reviewed in Wei and Deng, 1999; Seeger *et al.*, 2001; Schwechheimer and Deng, 2001a; Kim *et al.*, 2001; Chamovitz and Glickman, 2002).

To date, an unknown CSN-associated kinase activity has been shown to phosphorylate p53, I $\kappa$ B $\alpha$ , the NF $\kappa$ B precursor p105 and the CSN subunits CSN6 and Alien $\beta$  (Seeger *et al.*, 1998; Bech-Otschir *et al.*, 2001). Moreover, interference with mitogen-activated protein kinase (MAPK) signaling has been reported (Claret *et al.*, 1996; Spain *et al.*, 1996; Naumann *et al.*, 1999).

Furthermore, CSN is involved in degradation mechanisms of p53 and p27<sup>Kip1</sup>. Interestingly, CSN-dependent phosphorylation of p53 enhances its degradation by the ubiquitin pathway (Bech-Otschir *et al.*, 2001), whereas p27<sup>Kip1</sup> is prevented from degradation by CSN action. Thereby, CSN promotes de-neddylation of the SCF ubiquitin E3 ligase subunit Cullin (Cul1) by direct interaction with Alien $\beta$  regulating so SCF activity and ubiquitination of p27<sup>Kip1</sup> (Lyapina *et al.*, 2001; Yang *et al.*, 2002).

Additionally, CSN has a role in cell cycle control (Mahalingam *et al.*, 1998; Tomoda *et al.*, 1999; Bech-Otschir *et al.*, 2001). In line with stabilization of p27<sup>Kip1</sup>, CSN is able to negatively regulate G1/S transition (Yang *et al.*, 2002). Ambiguously, *csn24*-mutants of fission yeast revealed a positive role of the CSN in S/G2-phase (Mundt *et al.*, 1999).

Thus, the Alien isoform Alien $\beta$  as integrating subunit of the CSN plays an important role in wide-ranged CSN functions.

### 3. Objective

The general aim of this work was to further characterize and compare Alien $\alpha$  and its isoform Alien $\beta$ . As already mentioned Alien $\alpha$  and Alien $\beta$  are involved in a wide-ranged number of different cellular processes. This raises the need to define in more detail the cellular contexts in which Alien protein isoforms functionally participate.

At the beginning of this study little was known about the alien expression patterns and regulation had not been addressed. By way of analyses of alien expression patterns (mRNA and protein) in the rat, as an experimental model, it would be possible to obtain hints for special tissues and cell types where Alien function might be important.

Furthermore, identification of regulatory mechanisms for alien expression and function would help to understand the cellular processes in which Alien isoforms and their interaction partners are involved.

Since thyroid hormone is essential for brain development and the expression of the TR corepressor Hairless has been shown to depend on thyroid hormone in rat brain (Thompson, 1996; Potter *et al.*, 2001), it was interesting to investigate whether alien expression is also affected by hypothyroidism.

In addition, it has been reported that Alien $\beta$  is phosphorylated in the context of the CSN (Seeger *et al.*, 1998). Identification of the responsible protein kinase(s) would be useful to determine the non-hormone signaling pathways that may regulate functions of Alien protein isoforms.

Additionally, comparison of Alien $\alpha$  and Alien $\beta$  would bring light in common or different functional attributes of the two isoforms.

Identification of novel Alien-interacting factors will also help to define the biological relevance of Alien $\alpha$  and Alien $\beta$ .

## 4. Material and Methods

### 4.1 Material

#### 4.1.1 Equipment

96-well plate photometer	Versamax Microplate Reader
Agitator (Celloshaker)	Renner GmbH
Analytical balances	Sartorius
Autoclave	Matachana
Autoradiography cassettes	Fujifilm
Bench balance (Monoblock)	Mettler
CO <sub>2</sub> -Incubator (cell culture)	Hucoa Erlöss SA
Computer	Intel Pentium 4, Macintosh
Cryostate (Cryocut 1800)	Reichert-Jung
Electrophoresis systems	Biorad, Lagoplast
FAC-Scan	Becton Dickinson
Foil sealer	Polystar 242
Freezers (4°C, -20°C, -80°C)	Liebherr, AEG, Revco, Jouan
Glass pipettes	Fortuna SA
Geiger counter (Series 900-E)	Mini Instruments
Gel Dryer Model 583	BioRad
GeneAmp PCR system 2700	Applied Biosystems
Glass ware	Schott-Duran
Heat block	Grant QBT1
Ice machine	SIMAG
Incubator (bacteria; 37°C)	Selecta, New Brunswick Scientific
Instant Imager	Packard
Luminometer (Lumat LB9507)	EG&E Berthold
Micro pipettes	Gilson, Eppendorf
Microscope (Labovert FS)	Leitz
Microwave oven	SANYO
Orbital shaker	SBS
pH-Meter (Basic-20)	Cryson
Photometer	Milton Roy Company
Pipettors ("Pipett boy")	Integra Biosciences
Power supplies	Biorad
Protein blotting system	Biorad
RNA/DNA spectrometer-Genequant	Amersham Pharmacia Biotech
Scintillation $\beta$ -counters (1209 Rackbeta)	LKB Wallac
Sonifyer	Soniprep MSE
Steril bench	Faster Ultrasafe 36
Thermo mixer	SBS
UV gel imaging device	Stratagene
UV-cross linker (Stratalinker)	Stratagene
UV-Transluminators (366nm; 254nm)	Ultraviolet Products Inc.
Vortex	MSI Minishaker
Water bath (Unitronic 320 OR)	Selecta

Water purification system	Millipore
X-ray film processor	AGFA
Centrifuges (Rotors)	Hettich Microliter 12-24 Eppendorf Centrifuge 5415R Heraeus Minifuge GL Heraeus Cryofuge 20/30 (8730 6x90, 8750 4x90, 8780 8x90, 7790 6x500) Beckman J2-MC (JA 10, JA 14, JA 20, JS 7.5)

#### 4.1.2 General chemicals

(Only analytical grade chemical were used)

2-mercapto-1-methyl-imidazole (MMI)	Sigma
Acetic acid	Merck
Acetic anhydride	Merck
Acrylamide /Bisacrylamide	Biorad
Agar	Sigma, Gibco, Difco
Agarose	Sigma
Amino acids (additives to yeast media)	Roth, Sigma
Ammonium acetate	Sigma
Ammonium chloride	Sigma
Ammonium hydrogen carbonate	Sigma
Ammoniumpersulfate (APS)	Biorad
Ampicillin	Sigma
ATP	Sigma
Bactopeptone	Difco
Bactotryptone	Difco
Bovine serum albumin (BSA)	Sigma
Bromophenol blue	Merck
Chloramphenicol	Sigma
Chloroform	Merck
Citric acid	Sigma
Coomassie brilliant blue R	Serva
ddNTPs (ddATP, ddCTP, ddGTP, ddTTP)	Amersham Pharmacia Biotech
Denhardt's solution	IIB
Dextrane sulfate	Sigma
D-Galactose	Merck
D-Glucose	Merck
Dimethylsulfoxid (DMSO)	Gibco BRL, Sigma
Di-potassium hydrogen phosphate	Merck
Dithiothreitol (DTT)	Sigma
dNTPs (dATP, dCTP, dTTP, dGTP)	Amersham Pharmacia Biotech
EGTA-sodium	Sigma
Ethanol	Merck, Riedel de Haen
Ethidium bromide	Sigma
Ethylendinitrotetraacetic acid (EDTA)	Sigma

---

Formaldehyde	Merck
Formamide	Merck
Glutathione	Sigma
Glutathione-sepharose 4B	Amersham Pharmacia Biotech
Glycerol	Roth
Glycine	Merck
Guanidinium -HCl	Merck
Guanidinium-isothiocyanate	Sigma
Hydrogen peroxide	Merck
HEPES	Gibco
Hydrochloric acid (HCl)	Riedel de Haen
IPTG	Sigma
Isoamly alcohol	Merck
Isopropanol	Riedel de Haen
Kanamycin	Sigma
Lithium acetate	Sigma
Low melting agarose	USB
Magnesium acetate	Sigma
Magnesium chloride	Sigma
Manganese acetate	Merck
Manganese chloride	Sigma
Methanol	Merck
Methylene blue	Sigma
Nonidet P-40	Sigma
Oligo-dT-cellulose	Sigma
Orto-nitrophenylgalactoside (ONPG)	Sigma
Orto-vanadate	Sigma
p-aminobenzamidine agarose	Sigma
Paraformaldehyde	Sigma
Phenol	Sigma
Phenylmethylsulfonyl fluoride (PMSF)	Sigma
Piperazine-N,N'-bis (2-ethanesulfonic acid) (PIPES)	Sigma
Polyethylene glycol (PEG 3350)	Sigma
Potassium acetate	Merck
Potassium chloride	Merck
Potassium-di-hydrogen phosphate	Merck
Propidium iodide (PI)	Sigma
Protein-A-sepharose 4B CLB	Amersham Pharmacia Biotech
Protein-G-sepharose	Amersham Pharmacia Biotech
Raffinose	Merck
Salmon sperm DNA	Sigma
Sodium acetate	Sigma
Sodium chloride	Sigma
Sodium citrate	Sigma
Sodium deoxycholate	Sigma
Sodium hydrogen phosphate hydrate	Sigma
Sodium pyrophosphate	Sigma
Sodium salicylate	Merck
Sodium citrate	Merck
Sodiumdodecylsulphate (SDS)	Merck



Sodiumfluoride	Merck
Sodiumvanadate	Merck
Sucrose	Sigma
TEMED	Biorad
Toluidine blue	Sigma
Trichloro acetic acid	Merck
Triethanolamine	Sigma
Tris-Base	Merck
Triton X-100	Sigma
Trypsine	Gibco BRL
Tween 20	Sigma
Urea	Gibco BRL
X-gal (5-bromo-4-chloro-3-indoyl - $\beta$ -D-galactopyranoside)	Sigma
Yeast extract	Difco
Yeast tRNA	Sigma
YNB	Difco
$\beta$ -glycerophosphate	Sigma
$\beta$ -Mercaptoethanol	Merck

#### 4.1.3 Consumables

3MM Whatman paper	Whatman (Maidstone, UK)
6- <i>well</i> dishes	Nunc
96- <i>well</i> dishes	Nunc
Cell culture dishes	Nunc, Falcon
Cell culture media	Gibco
Cryo tubes	Nunc
Falcon-tubes (15 ml, 50 ml)	Falcon
Hyperfilm $\beta$ -MAX films	Amersham Pharmacia Biotech
Latex-gloves	Semperii TP GmbH
Micro test tubes	Eppendorf
Nitrocellulose membrane	Scleicher-Schüll
Pasteur pipettes	Brand
Petri dishes	Greiner, Sterilin
pH-test strips	Merck
Pipette tips	Eppendorf
Plastic cuvettes	Ratiolab
Plastic syringes	ICO
Polaroid films	Polaroid
PVDF membrane (Immobilon-P)	Millipore
Sterile filters (0.2 $\mu$ m, 0.8 $\mu$ m)	Sartorius
X-lay films (Biomax)	Kodak
Luminometer tubes	Sarstedt
FAC SCAN tubes	Kimble

#### 4.1.4 Kits and columns

Biorad-Dc-Protein Assay	Biorad
Rotiquant <sup>®</sup> Protein Assay	Roth
Concert <sup>™</sup> Maxi DNA Purification System	Gibco
Concert <sup>™</sup> Mini DNA Purification System	Gibco
Concert <sup>™</sup> Rapid Gel Extraction System	Gibco
ECL- Detection System	Amersham Pharmacia Biotech
<i>Ready to go</i> <sup>®</sup> -DNA Random Labeling Kit	Amersham Pharmacia Biotech
TNT-T7 Quick Transcription/Translation System	Promega
TRI-Reagent-RNA Extraction System	Mol. Res. Center Inc.
Chroma Spin <sup>®</sup> -100-DEPC-H <sub>2</sub> O COLUMNS	Clontech
Micro Spin <sup>®</sup> S-300 HR Columns	Amersham Pharmacia Biotech
Sephadex G-25 Columns	Amersham Pharmacia Biotech
Centricon-10 <sup>®</sup> Centrifugal filter units	Millipore

#### 4.1.5 Radioactive chemicals

<sup>35</sup> S-UTP; <sup>35</sup> S-Methionin	Amersham Pharmacia Biotech
<sup>32</sup> P-Phosphorus; <sup>32</sup> P-γATP; <sup>32</sup> P-dCTP	Amersham Pharmacia Biotech

#### 4.1.6 Enzymes

Alkaline phosphatase (CIAP)	MBI Fermentas
Klenow enzyme	Boehringer Mannheim
Restiction endonucleases	Gibco, MBI Fermentas, Boehringer Mannheim, New England Biolabs, Amersham Pharmacia Biotech
Ribonuclease-A	Sigma
Sp6-RNA polymerase	Boehringer Mannheim
T4-DNA ligase	Boehringer Mannheim
T7-RNA polymerase	Boehringer Mannheim
Thrombine	Amersham Pharmacia Biotech

#### 4.1.7 Antibiotics

<b>Ampicillin</b>	Stock: [100 mg/ml]	Sigma
	Final conc. [1:1000]	
<b>Chloramphenicol</b>	Stock: [34 mg/ml]	Sigma
	Final conc. [1:200]	
<b>Kanamycin</b>	Stock: [100mg/ml]	Sigma
	Final conc. [1:1000]	

#### 4.1.8 Antibodies

$\alpha$ -Alien	(Pep-AK1)	Dressel <i>et al.</i> , 1999
$\alpha$ -cdc2	(Rab4)	Paul Nurse Lab
$\alpha$ -cycA	sc-596	Santa Cruz Biotech
$\alpha$ -cycB	(191)	J. C. Labbe Lab (CNRS, Montpellier)
$\alpha$ -JNK	sc-474	Santa Cruz Biotech
$\alpha$ -p38	sc-535	Santa Cruz Biotech
$\alpha$ -ERK	sc-154	Santa Cruz Biotech
$\alpha$ -HA-tag	sc-7392	Santa Cruz Biotech
$\alpha$ -myc-tag	(9E10)	(Evan <i>et al.</i> , 1985)
$\alpha$ -HRP mouse		ICN Biomedicals
$\alpha$ -HRP rabbit		ICN Biomedicals
$\alpha$ -HRP goat		ICN Biomedicals

#### 4.1.9 Stimuli, inhibitors, hormones, anesthetics, substrates [final conc.]

Anisomycin		[10 $\mu$ g/ml]	Sigma
Forskolin		[10 $\mu$ M]	Sigma
Human epidermal growth factor (hEGF)		[10 $\mu$ g/ml]	Peppo Tech
TPA		[10 nM]	Sigma
Tumor necrosis factor $\alpha$ (TNF $\alpha$ )		[10 ng/ml]	Peppo Tech
UV light (Stratalinker)		[60 J/m <sup>2</sup> ]	Stratagene
IPTG		[1-1.2 mM]	Sigma
Actinomycin		[2.5 $\mu$ g/ml]	Sigma
Aprotinin		[10 ng/ml]	Sigma
Cycloheximide		[10 $\mu$ g/ml]	Sigma
Hydroxy urea		[2 mM]	Sigma
Leupeptin		[10 ng/ml]	Sigma
Mimosine		[0.5 mM]	Sigma
Nocodazol		[50 ng/ml]	Sigma
PMSF		[100 $\mu$ M]	Sigma
Thymidine		[2.5 mM]	Sigma
Thyroxin (T4)	[1.8 $\mu$ g/100g body weight]		Sigma
Triiodothyronine (T3)		[150 nM]	Sigma
Phenobrabital	Stock: [65 mg/ml]		Generic
Ketamin (Ketanest <sup>®</sup> )	Stock: [5 mg/ml]		Pfizer
Myelin basic protein (MBP)	Stock: [10 mg/ml]		Sigma
Histone fraction	Stock: [10 mg/ml]		Sigma
Luciferin			Sigma

#### 4.1.10 DNA, RNA and protein molecular weight markers

DNA: 100bp DNA Ladder, 1kb DNA Ladder	Gibco
RNA: RNA Ladder	Gibco
Protein: Benchmark™ Prestained Protein Ladder	Gibco

#### 4.1.11 Informatics

##### Hardware:

CPU:	Micostar, Intel Pentium 4, 1,7 GHz Macintosh G3-Power-PC
Scanner:	Agfa Studioscan
Printers:	Hewlett Packard, Epson

##### Software:

MacOS  
Microsoft Windows XP/Mac, Office XP/Mac  
Adobe Photoshop 6.0, Acrobat Reader 5.0  
Endnote 3.0  
NIH Image 1.0  
Netscape 6.0  
Versamax Pro  
Cell Quest

##### Internet resources:

**Pubmed:** <http://www.ncbi.nlm.nih.gov/entrez/query.fcgi?db=PubMed>

**Netphos 2.0:** <http://www.cbs.dtu.dk/services/NetPhos/>

**PhosphoBase:** <http://www.cbs.dtu.dk/databases/PhosphoBase/>

**Peptide Cutter:** <http://us.expasy.org/tools/peptidecutter/>

**Protein Kinase Resource:** <http://pkr.sdsc.edu/html/index.shtml>

#### 4.1.12 Bacterial strains

**HB101** (Boyer and Roulland-Dussoix, 1969; Sambrook *et al.*, 1989)

Genotype: F<sup>-</sup>  $\Delta$ (gpt-proA)62 leuB6 supE44 ara-14 galK2 lacY1  $\Delta$ (mcrC-mrr) rpsL20(Str<sup>R</sup>) xyl-5, mtl-1 recA13. This strain is not able to metabolize arabinose, galactose or xylose and needs proline in the culture medium to grow. HB101 suppress amber (UAG) mutations and is resistant to streptomycin due to a mutation in the 30S ribosomal subunit. Furthermore, these bacteria are deficient for *E. coli*-specific DNA-restriction-, modification-(hsd), recombination- and repair systems (mcr- and mrr-system).

**DH5 $\alpha$**  (Gibco BRL)

Genotype: F<sup>-</sup>  $\phi$ 80*dlacZ.M15*  $\Delta$ (*lacZYA-argF*)U169 *endA1 recA1 hsdR17*(r<sub>K</sub><sup>-</sup> m<sub>K</sub><sup>+</sup>) *deoR thi-1 phoA supE44  $\lambda$ <sup>-</sup>gyrA96 relA1*. These cells are suitable for the construction of gene banks or for the generation of cDNA libraries using plasmid-derived vectors. The  $\phi$ 80*dlacZ.M15* marker provides  $\alpha$ -complementation of the  $\beta$ -galactosidase gene from pUC or similar vectors and, therefore, can be used for blue white screening of colonies on plates containing X-gal and IPTG. DH5 $\alpha$  are capable to be transformed with large plasmids.

**BL21-SI<sup>TM</sup>** (Donahue and Bebee, 1999)

Genotype: F<sup>-</sup> *proUp::T7RNAP::malQ-lacZ ompT lon endA1 hsdSB*(r<sub>B</sub><sup>-</sup>, m<sub>B</sub><sup>-</sup>) *gal dcm Tcs*. This bacterial strain is host for protein expression like e.g. GST- or HIS-tagged proteins for their subsequent purification. BL21-SI allows expression from salt-inducible T7 RNA polymerase promoter or IPTG-inducible *lac/tac*-promoter. Note: once transformed it is extremely difficult to prepare plasmid DNA from BL21-SI using standard techniques.

**4.1.13 Yeast strain****EGY48** (Golemis and Brent, 1992)

Genotype: MAT $\alpha$  *his3 trp1 ura3-52 leu2: pLEU2-LexAop6*.

This yeast strain is suitable for protein interaction studies using the yeast-two-hybrid system with adequate vectors. Mutations in the genes for histidine (HIS), tryptophan (TRP) and uracil (URA) allow to transform and select for up to three different yeast expression plasmids carrying intact genes for the above-mentioned amino acids. Furthermore, a chromosomal integrated copy of the LEU2 gene coding for leucine makes possible a selection for EGY48 in LEU-deficient medium.

**4.1.14 Eukaryotic cell lines****N2A** (ATCC N<sup>o</sup>: CCL-131)

The N2A cell line was established by R.J. Klebe and F.H. Ruddle in the Jackson Laboratory, Bar Harbor, Maine (Klebe *et al.*, 1970) from a spontaneous tumor of a strain-A albino mouse. These cells lack transforming tumor viruses and present a non-differentiated phenotype in cell culture (Lebel *et al.*, 1994). N2A cells furthermore lack

detectable amounts of thyroid hormone receptors and served as parental cell line to derive the following two cell lines. These cells grow in monolayers in DMEM medium supplemented with 25 mM Hepes pH 7.4 and 10% fetal calf serum (FCS). As transfection method the calcium phosphate-method can be used.

#### **N2A-TR $\alpha$ and N2A-TR $\beta$** (Lebel *et al.*, 1994)

N2A-TR $\alpha$  and N2A-TR $\beta$  cells are N2A-derivates and were generated by stably transfecting either thyroid hormone receptor  $\alpha$  or  $\beta$ . These brain derived cells differentiate upon T3 treatment and thus are used to study neuronal differentiation or T3 effects (Lebel *et al.*, 1994; Cuadrado *et al.*, 1999; Perez-Juste and Aranda, 1999).

#### **HeLa** (ATCC N $^{\circ}$ : CCL-2)

This cell line was derived from a human cervical carcinoma. HeLa cells show epithelial morphology and grow as monolayers in standard DMEM medium supplemented with 10% FCS at 37°C in 5% CO<sub>2</sub> atmosphere. They are positive for expression of human papillomavirus. HeLa cells can be transfected by the calcium phosphate -method.

#### **C33A** (ATCC N $^{\circ}$ : HTB-31)

This line was derived by N. Auersperg from cervical cancer biopsies. In contrast to HeLa cells this line is negative for human papillomavirus DNA and RNA. The retinoblastoma protein (RB) is present but abnormal in size and has been shown to be non-functional (Scheffner *et al.*, 1991). p53 expression is elevated and there is a point mutation at codon 273 resulting in a Arg to Cys substitution. Furthermore, the cells harbor extremely low levels of BRG1 a core unit of the SWI/SNF complex (Murphy *et al.*, 1999; Zhang *et al.*, 2000; Harbour and Dean, 2000a). Therefore, C33A cells are a cell line of choice for investigation of Rb and SWI/SNF functions. These cells are well transfectable using the calcium phosphate-method. They were grown in standard DMEM medium supplemented with 10% FCS at 37°C in 5% CO<sub>2</sub> atmosphere.

#### **HEK293** (ATCC N $^{\circ}$ : CRL-1573)

The HEK293 cell line is a permanent line of primary human embryonal kidney transformed by sheared human adenovirus type 5 (Ad 5) DNA. The cells express the transforming gene of adenovirus 5. Therefore, viral promoters are very efficiently

expressed. The cells show epithelial morphology and grow in monolayers on adequate cell culture dishes. They easily detach from the substrate and therefore should be handled with care when e.g. transfected. HEK293 cells are efficiently transfected using the calcium phosphate-method. They were grown in standard DMEM medium supplemented with 10% FCS at 37°C in 5% CO<sub>2</sub> atmosphere.

#### 4.1.15 Animals

White wistar rats maintained in the animal facilities of the *Instituto de Investigaciones Biomédicas* were used for the studies reported here. All efforts were made to minimize animal suffering, and to reduce the number of animals used. The maintenance and handling of the animals were as recommended by the European Communities Council Directive of November 24<sup>th</sup>, 1986 (86/609/EEC). Technical assistance and animal care: M. Gonzalez, F. Núñez and P. Señor (IIB/CSIC, Madrid).

#### 4.1.16 Provided plasmids

##### A. Baniahmad's group:

The following plasmids were cloned in or provided from the group of Dr. Aria Baniahmad (Baniahmad *et al.*, 1992; Baniahmad *et al.*, 1995; Dressel *et al.*, 1999; Altincicek *et al.*, 2000; and unpublished).

**U. Dressel:** pAB-hAlien $\alpha$  (=pAB-TRIP15 $\Delta$ gal), pABgalTRIP15, pGST-TRIP15, pHA-Alien $\alpha$

**D. Thormeyer:** pEG-term, pEG-term-Rb<sub>706</sub>, pEG-TRIP15, pJG-TRIP15<sub>66-264</sub>, pJG-TRIP15<sub>1-128</sub>.

**B. Altincicek:** pT7-TRIP15, pJG-TRIP15<sub>128-305</sub>, pJG-hTRb-ct, pJG-Rb-P, pJG-Rb-A, pJG-Rb-B, pJG-TRIP15<sub>1-66</sub>, pGST-hTR ct

**A. Baniahmad:** pABgalv-erbA<sub>346</sub>, p4xUAS-TATA-LUC, pGST-linker, pT7-hTRbct, pGST-Alien $\beta$ , pHA-linker

Plasmids supplied form others:

These plasmids were kindly provided from various laboratories or investigators as indicated.

pcDNA3-flag-CSN2	M. Naumann's lab;
pJG-4-5, pSH-18-34 _____	R. Brent's lab;
pJG-TRIP15 _____	D. Moore's lab;
pCITE-Rb _____	M. Serrano's lab;
pGST-Rb <sub>379-928</sub> , pGEX-SP1 f.l., pGEX-hE2F1 f.l. _____	M. Campanero;
pM2-Rb, pM2-Rb-P, pM2-Rb <sub>706</sub> _____	D.C. Dean's lab;
pE2F-LUC; pE2Fmut-LUC _____	P. Sanisteban's lab;
pGEX-SEK1-KD _____	E. Rubie's lab;
p-63-Col-LUC, p-73-Col-LUC _____	A. Muñoz' lab;
pCMV-Rb-f.l. _____	E. Harlow's lab;
pMT2-chAlienβ _____	H. Stunnenberg's lab;
p-myc-MLK2 _____	D.S. Dorrow's lab;
pGAG, pGAM _____	A. Butler's lab.



## 4.2 Methods

### 4.2.1 Preparations

All buffers or media were prepared with autoclaved ultra pure water from the Millipore water purification system (Millipore). The solutions were sterilized by either autoclaving or sterile filtering. In most cases, high-concentrated stock solutions were used to prepare the buffers, however, the indicated concentrations are referred to as final concentrations.

### 4.2.2 Growth and storage of bacteria

Lauria-Bertani (LB) growth medium was used for reproduction of bacteria. LB medium contains 10 g/l bactotrypton, 5 g/l yeast extract, 5 g/l NaCl in Millipore water. To produce solid medium in Petri plates 15 g/l Agar and antibiotics of choice were added. Bacteria were cultured at 37 °C in presence of the adequate antibiotics under agitation in case of liquid cultures in an incubator or in the institute's warm room. Single clones were obtained by separation on LB-Agar plates. For long term storage aliquots of an o/n-bacteria culture was supplemented with glycerol up to 20% and frozen at -70 °C.

### 4.2.3 Production of competent bacteria

Transformation-competent bacteria were produced using the CaCl<sub>2</sub>-method on ice using ice-cold buffers and pre-cooled centrifuges (Sambrook *et al.*, 1989). Therefore, a 3 ml o/n-culture of bacteria was grown in 200 ml pre-warmed LB medium up to OD<sup>600</sup> of 0.6. After spinning down (15 min, 4°C, 4000 rpm, Beckmann JA10), the bacterial pellet was resuspended with caution in 20 ml of 10 mM NaCl and made up to 100 ml with 100 mM CaCl<sub>2</sub>. The suspension was again centrifuged (as before) the pellet was now resuspended in 80 ml of 100 mM CaCl<sub>2</sub> and stored on ice for 30 min. Then the solution was spun down (as before) and the pellet was resuspended in 20 ml 100 mM CaCl<sub>2</sub>. After incubation for 3-4 h on ice, the suspension was mixed carefully with sterile glycerol up to 30% and 200 µl aliquots were shock frozen in liquid N<sub>2</sub> and stored at -70 °C.

#### 4.2.4 Transformation of bacteria

A 200 µl aliquot of transformation competent bacteria was thawed on ice and 1-100 ng of the plasmid DNA to transform was added. The cells were incubated on ice for 30 min before performing a heat shock (2 min, 37 °C). Immediately after the heat shock 1 ml of cold LB medium was added and the reaction was incubated for another 30 min at 37 °C in case of ampicillin resistance or 1h in case of kanamycin resistance. Thereafter, the bacteria were centrifuged for 1 min at 4000 rpm, resuspended in 200 µl of LB and plated on pre-warmed LB-Agar plates supplemented with adequate antibiotic. The bacteria were grown o/n at 37 °C in the bacteria incubator to obtain single colonies.

#### 4.2.5 Expression and purification of recombinant proteins in bacteria

Recombinant GST-proteins were produced in the bacterial strain BL21-SI (4.1.12). A 3 ml o/n-culture of BL21-SI transformed with the GST-fusion plasmid of choice was grown in 0.4-1 l of pre-warmed LB medium up to OD<sub>600</sub> of 0.3-0.5. IPTG at a final concentration of 1-1.2 mM was added to induce the IPTG-inducible *lac/tac* promoter. The culture was incubated under agitation for 3-5 h at 30-37 °C depending on the stability of the produced protein. Then the bacteria were harvested by centrifugation (15 min, 4°C, 4000 rpm, Beckmann JA10) and resuspended in 10 ml NETN (100 mM NaCl, 1mM EDTA, 20 Tris/HCl pH 8.0, 0.5% NP-40 (v/v), 1 mM DTT (freshly added)). Bacterial lysis was performed by sonifying on ice (10 cycles: 10 sec on - 10 sec off). Insoluble debris was removed by centrifugation (30 min, 4 °C, 13000 rpm, Beckmann JA10). The further purification of the GST-fusion proteins is described in chapter 4.2.8.

#### 4.2.6 Manipulation of DNA

##### Storage

DNA was stored at -20 °C in TE buffer (10 mM Tris/HCl pH 7.6, 1 mM EDTA). The concentration of DNA was measured in a Genequant Pro™-photometer (Amersham Pharmacia Biotech) at 260 nm.

##### DNA purification

Large-scale plasmid DNA preparation were performed from 500 ml LB cultures of freshly transformed bacteria (HB101 or DH5α strains) applying the Concert™ Maxi DNA Purification System (Gibco BRL) following the manufacturers suggestions. This

kit is based on a modified alkaline lysis method (Sambrook *et al.*, 1989) combined with resin-matrix gravity flow columns. These plasmid preparations are suitable for cloning *in vitro* translation/transcription or transfection in eukaryotic cells

For rapid small-scale plasmid DNA preparations, the Concert™ Mini DNA Purification System (Gibco BRL) or the standard alkaline lysis procedure (Sambrook *et al.*, 1989) was chosen. The plasmid DNA yielded by this method was used for restriction- or sequence analysis or transformation in BL21-SI bacteria for production of recombinant proteins.

#### Sequence analysis

DNA sequence analysis was performed by the sequencing service of the IIB using fluorescent PCR sequencing method to verify recombinant plasmids. Standard oligonucleotide primers (e.g. T7, SP6) were used and provided by the same service.

#### Phenol/chloroform extraction

This method is used to remove proteins from aqueous DNA solutions (Ausubel *et al.*, 1989). For that purpose, the DNA solution was mixed well with one volume of phenol/chloroform/isoamyl alcohol (25:24:1) using a vortex and was centrifuged to separate organic and aqueous phases (5 min, RT, Heraeus minifuge). The upper aqueous phase was transferred to a new tube and mixed well with one volume of chloroform/isoamyl alcohol (49:1) to remove residual phenol from the DNA solution. After centrifugation, the upper aqueous phase was recovered and the DNA was precipitated with two volumes ethanol and 0.1 volumes 3M sodium acetate for 10 min on ice. The precipitated DNA was spun down (15 min, RT, 13000 rpm, Heraeus minifuge), the pellet was washed with 70% ethanol and finally resuspended in 1x TE.

#### Digestion of DNA using restriction endonucleases

Type II restriction endonucleases are enzymes that digest DNA in a sequence specific fashion. Depending on the restriction enzyme, the resulting DNA fragment may have sticky (3' or 5' overhang) or blunt ends. The conditions for DNA digestions vary for the different restriction enzymes and are provided by the manufacturer. In the case that two different restriction enzymes with incompatible reaction buffers were used, the digestion with the enzyme requiring low salt conditions was performed first. If not

possible, the DNA solution was phenol/chloroform extracted (see above) between the two reaction steps.

#### Blunting sticky ends

In some cases, cloning of DNA fragments requires digestion with restriction enzymes that generate incompatible ends. In this case sticky ends (3'- and 5'-overhanging) need to be blunted to make DNA ligation possible. For that purpose, the DNA fragments were treated with Klenow enzyme (Klenow-fragment of the DNA polymerase I from *E. coli*). This enzyme catalyzes the complementary aggregation of nucleotides to 3'-overhanging sticky ends filling them up to blunt ends (5'-3' polymerase activity). 5'-overhanging sticky ends are removed by the Klenow enzyme's 3'-5' exo-nuclease activity also generating blunted ends. The reaction mixture was as follows: 1 µg DNA, 1.5 µl dNTPs (5 mM each), 2.0 µl 10x reaction buffer, 1.0 µl Klenow enzyme (2 U/µl), filling up with H<sub>2</sub>O up to 20 µl - incubation 30 min at 37 °C.

#### Dephosphorylation

To avoid plasmid vector religation in DNA ligation reactions the vectors 5'-phosphate ends can be removed. This significantly increases the yield of recombinant plasmids. Dephosphorylation is performed by treatment of the linearized plasmid with alkaline phosphatase (CIAP = calf intestine alkaline phosphatase or SAP = shrimp alkaline phosphatase). The reaction was performed with one unit of CIAP for 15 min at 37 °C. The phosphatase was removed from the DNA solution by phenol/chloroform extraction or isolation of the DNA fragment by agarose gel electrophoresis.

#### Agarose gel electrophoresis and extraction of DNA fragments from agarose gels

To visualize DNA restriction analyses or to separate DNA fragments (vectors and inserts or cDNA probes) obtained by digestion with restriction enzymes the DNA, was submitted to agarose gel electrophoresis. The DNA migrates through the agarose matrix (0.6-1.2% agarose in 1x TAE - 0.4 M Tris, 10 mM EDTA, pH 8.0, 0.2-0.5 µg/ml ethidium bromide) from the negative to the positive charged pole (5 V/cm gel length) and is separated by fragment size. To purify DNA fragments from such gels the fragment of choice was cut out of the gel on a 365 nm UV-transluminator. The DNA

was extracted from the gel slice using the Concert™ Rapid Gel Extraction System (Gibco BRL) following the manufacturers indications.

In some cases, the DNA fragments generated by restriction enzyme digestion with the goal to clone recombinant plasmids were separated in 0.8% low-melting agarose (USB) gels. Thereby, ligation of DNA fragments does not require purification from the agarose, but dilution of the cut-out gel slice containing the desired DNA fragment to 0.2% agarose content with H<sub>2</sub>O. The dilution was dissolved at 65 °C for 10 min and it was ready to perform *in gel* ligation.

#### Ligation of DNA fragments

DNA ligase catalyzes the establishment of phosphodiester-unions of 3'-hydroxyl and 5'-phosphate ends of DNA depending on magnesium and ATP (Ausubel *et al.*, 1989). This reaction is used to combine restriction enzyme digested and purified DNA fragments with the purpose to create recombinant plasmids ("*cloning*"). Thereby, molar quantities of vector and insert in a ratio of 1:2 for sticky-sticky and 1:3 for blunt-blunt ligations were put in the ligation reaction using T4 DNA ligase (Boehringer Mannheim) following the manufacturers indications. The reaction was incubated 12-20 h in the dark at RT for sticky-sticky and at 4 °C for blunt-blunt ligations. After that, the ligation reaction was transformed in transformation-competent bacteria and the plasmid DNA of resulting recombinant bacteria was analyzed by restriction analysis and verified by sequencing if necessary.

### **4.2.7 Manipulation of RNA**

#### Storage

The concentration of RNA preparations was measured in a Genequant Pro™ photometer (Amersham Pharmacia Biotech) at 260 nm. RNA was conserved at -70 °C in H<sub>2</sub>O.

#### RNA extraction and Northern analysis:

Total RNA preparation from N2A and derivate cells from 10 cm cell culture dishes, was performed using TRI REAGENT® (Molecular Research Center Inc.) following the manufacturer's instructions. Total RNA from rat tissues was obtained by the guanidinium isothiocyanate-phenol-chloroform procedure (lysis buffer: 4 M guanidinium isothiocyanate, 0.1 M Tris/HCl pH 7.5, 1% β-mercaptoethanol;

Chomczynski and Sacchi, 1987). For Northern analysis of rat brain tissue polyA<sup>+</sup> RNA was then purified by affinity chromatography oligo (dT)-cellulose method (Sambrook *et al.*, 1989). In this case six micrograms of poly A<sup>+</sup> RNA pooled from brains of the different developmental ages (from eight animals in case of E19 and P0, seven for P5 and five for each P10 and P15) of control (C), hypothyroid (H) or T4-treated hypothyroid (H+T4) animals were loaded in each lane. RNAs were fractionated in formaldehyde agarose gels and blotted onto nitrocellulose membranes (Schleicher-Schüll) following standard techniques (Sambrook *et al.*, 1989). As control, the filters were stained in a 0.02 % methylene blue solution prepared in 0.3 M sodium acetate to check integrity of RNA samples and to visualize the ribosomal RNA that was used as loading control to quantify Alien mRNA content. Radioactive cDNA probes were prepared by random priming procedure (Feinberg and Vogelstein, 1983), applying the "Ready to go"- DNA labeling kit (Amersham Pharmacia Biotech) using 50 µCi of <sup>32</sup>P-dCTP per reaction. The hAlien cDNA (Dressel *et al.*, 1999) was used for Northern hybridization. The membranes were pre-hybridized in a sealed plastic bag at least 4 h at 65 °C in Church buffer (7% SDS (w/v) 1 mM EDTA, 2.5x phosphate buffer (170 mM KH<sub>2</sub>PO<sub>4</sub>, 720 mM K<sub>2</sub>HPO<sub>4</sub> (10x)) in a water bath. Hybridization was then carried out o/n at 65 °C in Church buffer containing the labeled cDNA probe (130000-450000 cpm) and 500 µg sheared salmon sperm DNA. The membranes were washed the next day twice for 20 min in Northern washing buffer (2.5 x phosphate buffer, 1% (w/v) SDS) at 65 °C under agitation. When indicated, the membranes were re-hybridized with <sup>32</sup>P-labeled cyclophilin cDNA probe as loading control and for densitometric quantification.

#### **4.2.8 Manipulation of proteins**

##### Storage

Protein extracts were stored at -70 °C.

##### Determination of protein concentration

The concentration of protein extracts was determined depending on the composition of the used lysis buffer. If the lysis buffer contained detergents, the Biorad-Dc-Protein-Assay<sup>®</sup> (Biorad) was used. Samples obtained with lysis buffer lacking detergents were measured using Rotiquant<sup>®</sup> Bradford protein assay (Roth). The intensity of the color reactions was quantified in 96 well-plates in a Versamax Microplate Reader<sup>®</sup> photometer with Versamax Pro software calculating the protein concentration.

### SDS-PAGE

SDS-polyacrylamide gel electrophoresis (SDS-PAGE; Laemmli, 1970) was used to separate proteins from cell or tissue extracts by their molecular weight using standard methods (Ausubel *et al.*, 1989; Sambrook *et al.*, 1989). Protein samples were prepared by denaturation for 3 min at 100 °C in SDS loading buffer (10 mM Tris/HCl pH 6.8, 20% Glycerol, 3% SDS (w/v), 1 mM DTT, 0.6% bromophenol-blue). The manufacturers Biorad and Lagoplast provided electrophoresis systems of different sizes and thickness. Gels of 8-12% acrylamide/bisacrylamide content were used in these studies and Benchmark™ Prestained Protein Ladder (Gibco) served as molecular weight standard. The gels containing the separated proteins were visualized in some cases by Coomassie-blue staining (40% methanol, 10 acetic acid, 0.035% Coomassie-brilliant-blue) and subsequently dried in a vacuum gel dryer (Biorad).

### Immunoblotting (Western blot)

Samples of brains of fifteen day old rats were lysed by homogenization in appropriate volumes of tissue lysis buffer (20 mM Tris/HCl pH 7.9, 25% glycerol, 420 mM NaCl, 1% Nonidet P-40, 1.5 mM MgCl<sub>2</sub>, 0.2 mM EDTA, 200 mM β-glycerophosphate, 0.5% (w/v) sodium deoxycholate, 0.5 mM dithiotreitol (DTT) 100 μg/ml PMSF, 10 μg/ml leupeptin, and 10 μg/ml aprotinin). In case of protein preparation from cell culture, cells of a 6 cm dish were washed in ice-cold phosphate-buffered saline, and lysed in Nonidet P-40 lysis buffer (0.1% SDS, 1%, Nonidet P-40, 50 mM Tris-HCl, pH 8, 150 mM NaCl, 5 mM EDTA, 1 mM, PMSF, 10 μg/ml leupeptin, and 10 μg/ml aprotinin). After separation of equal amounts of protein by SDS-PAGE and blotting on PVDF-membranes (Biorad liquid transfer protein blotting system; PVDF-Immobilon-P, Millipore), Western analysis was performed by using rabbit anti-Alien peptide antibody (Pep-AK1; Dressel *et al.*, 1999) diluted 1:2000 in the blocking solution (4% BSA in Tris-buffered saline and 0.1% Tween 20) for 2 h at room temperature. The proteins were visualized by enhanced chemiluminescence detection method (ECL, Amersham Pharmacia Biotech). After that, the same PVDF-membranes were Coomassie-stained as loading control.

### Immunoprecipitation

Immunoprecipitation was used during this work to isolate specific proteins from raw extracts to perform *in vitro* kinase assays and to isolate *in vivo*-<sup>32</sup>P-labeled HA-Alien protein isoforms. The different lysis buffers are described in the corresponding paragraphs. After cell lysis (300 µl ice-cold lysis buffer per 6 cm cell culture dish) for 30 min on ice the raw extracts were separated from cell debris by centrifugation (15 min, 4 °C, 13000 rpm, Eppendorf centrifuge). The supernatant was transferred to a new tube and incubated with the adequate antibody at 4 °C in an orbital shaker for 1-3 h. The quantities of the antibodies used are also indicated in the corresponding paragraphs. After that, 20-30 µl protein-A or -G sepharose bead suspension (depending on the antibody) equilibrated in the used lysis buffer was added. The probes were again incubated for 1-3 h at 4 °C in the orbital shaker, then centrifuged (1 min, 4 °C, 3000 rpm, Eppendorf centrifuge) and washed at least 3 times in washing buffers indicated in the respective paragraph. The pellet containing the antibody-bound protein and the protein-A or -G sepharose were then further processed in the different assays.

### Purification and concentration of recombinant proteins

To affinity-purify GST-fusion proteins produced as described in chapter 4.2.5, 300 µl of a 50% suspension of equilibrated glutathion-4B sepharose beads ("GS-beads", Amersham Pharmacia Biotech) in NETN were added to 10 ml of bacterial extract containing the GST-fusion protein in a 15 ml Falcon tube. After 1-3 h incubation rocking at 4 °C the GS-beads were centrifuged at 3000 rpm at 4 °C for 5 min and washed 3 times in ice-cold NETN. After the last washing step the GS-beads the bound GST-fusion protein was thrombine digested (see later) or eluted three times with 300 µl of 10 mM glutathion in 50 mM Tris/HCl pH 8.0 rocking at 4 °C. After elution, glutathion was removed from the resulting protein solution of eluated GST-protein by gel filtration through a Sephadex-25 column (Amersham Parmacia Biotech) eluting with phosphate-buffered saline (PBS; 120 mM NaCl, 28 mM Na<sub>2</sub>HPO<sub>4</sub>, 2.5 mM KH<sub>2</sub>PO<sub>4</sub>). Finally, the flow-through was concentrated by ultra filtration using Centricon-10<sup>®</sup> Centrifugal filter units (Millipore) for 2-5 h at 4 °C (6000 rpm, Beckmann JA10). The proteins purified by this procedure were used for GST-pulldown interaction assays or as substrates for *in vitro* kinase assays.



### Thrombine digestion

In some cases, the GST-protein was eluted by thrombine (Amersham Pharmacia Biotech) digestion cutting of the GST-tag. Thrombine was used at 20 U/ml (in 500  $\mu$ l protein extract) at 4 °C for at least 1-2 h. To get rid of thrombine, the eluate was incubated with 80  $\mu$ l of a p-aminobenzamidine agarose suspension (Sigma) rocking at 4 °C for 30 min. To remove p-aminobenzamidine agarose the reaction was centrifugated at 4 °C at 3000 rpm. Finally, presumably residual thrombine was inactivated by addition of 8 mM PMSF to the protein extract (Ausrubel *et al.*, 1989). The concentration of the purified recombinant proteins was measured using Biorad-Dc-Protein Assay<sup>®</sup> (Biorad) and the integrity of the protein was visualized by SDS-PAGE staining the gel with Coomassie-blue (40% methanol, 10 acetic acid, 0.035% Coomassie-brilliant-blue). The yielded recombinant proteins are suitable as substrates for *in vitro* kinase assays or were used as competitors in GST-pulldown competition experiments.

### *In vitro* translation/transcription ("TNT reaction")

In this work, the TNT-T7 Quick Transcription/Translation System<sup>™</sup> (Promega) was used to produce proteins from adequate T7-RNA polymerase containing plasmids harboring cDNAs coding for the desired proteins. During TNT-reaction, <sup>35</sup>S-labeled methionine was added to obtain radioactive proteins. However, in the case of the GST-pulldown competition assays, competitor protein was translated in the purpose of non-radioactive methionine. The reaction was performed as suggested by the manufacturer.

### *In vitro* protein-protein interaction assay (GST-pulldown)

To assay protein-protein interactions *in vitro*, bacterially expressed and purified recombinant GST-fusion proteins (4.2.5 and this chapter) were incubated with *in vitro*-translated <sup>35</sup>S-labeled proteins (Ausrubel *et al.*, 1989; Sambrook *et al.*, 1989). The reactions were affinity purified with glutathion sepharose beads that specifically bind GST-fusion proteins. In case of interaction, the co-precipitated <sup>35</sup>S-labeled protein is detected by autoradiography of the dried gel.

For pulldown assays, 2-4  $\mu$ g of purified GST-fusion proteins were incubated in 500  $\mu$ l NETN (see 4.2.5) with 25  $\mu$ l glutathion sepharose 4B beads (Amersham Pharmacia Biotech; equilibrated in NETN) for 30 min rocking in an orbital shaker at 4 °C. The samples were spun down (1 min, 4°C, 3000 rpm, Eppendorf centrifuge) and washed

twice in NETN before blocking unspecific interactions with 100  $\mu\text{g}$  BSA (5  $\mu\text{l}$  [20  $\mu\text{g}/\text{ml}$ ] BSA) for 15-30 min rocking at 4  $^{\circ}\text{C}$ . The probes were washed three times with 1 ml NETN and twice with 1 ml TWB (20 mM Hepes pH 7.9, 60 mM NaCl, 6 mM  $\text{MgCl}_2$ , 8.2% (v/v) Glycerol, 0.1 mM EDTA, 1 mM DTT). After the last washing step the pellets were resuspended in 50  $\mu\text{l}$  TWB and 5  $\mu\text{l}$  of a 25  $\mu\text{l}$  TNT reaction and 1  $\mu\text{l}$  BSA ([20  $\mu\text{g}/\text{ml}$ ]) were added. To perform the binding reaction, the samples were incubated for 1 h at RT in an orbital shaker. Before performing the washing steps, the samples were centrifuged and 10-20% of the binding reaction from the tubes containing the control sample with GST-protein alone was removed to obtain 10 or 20% of the radioactive input. This input was run on the SDS gel separately to quantify the %-binding efficiency of supposed protein interactions and to control the *in vitro* translation reaction and the integrity of the translated protein. Thereafter, the probes were washed 6 times with TWB and denaturated for 3 min at 100  $^{\circ}\text{C}$  in SDS loading buffer (see SDS-PAGE). After separating the proteins by SDS-PAGE, the gel was Coomassie stained, de-stained and shortly washed with water before incubation of the gel in 1M sodium salicylate for 30 min to amplify  $^{35}\text{S}$  signals. Finally, the gel was dried in a vacuum gel dryer (Biorad) at 65  $^{\circ}\text{C}$  and exposed to an X-ray film. In some cases, the blocking of the binding reaction was performed in presence of 20% fat-free milk.

#### GST-pulldown competition

GST-pulldown competition assays were performed basically as described in the previous paragraph. The only difference is the presence of competitor proteins in the binding reaction. In case of competition with recombinant proteins, thrombine-digested and purified proteins were used (see purification and concentration of recombinant proteins). The different amounts of these competitors were equalized with BSA up to 2  $\mu\text{g}$  in each binding reaction. When *in vitro*-translated proteins (non-radioactive) were used as competitors, the different volumes of TNT reaction were filled up to equal volumes with TNT-reticulocyte lysate.

#### *In vitro* kinase assays

All *in vitro* kinase assays were basically performed as described in the paragraph "MAP-kinase assay" (modified from Coso *et al.*, 1995). In all assays two  $\mu\text{g}$  of bacterial expressed and purified GST, GST-Alien $\alpha$  and GST-Alien $\beta$  were investigated for phosphorylation by the different kinases. Modifications such as specific stimuli,

positive control substrates, concentration of non-radioactive ATP (that is specific for each type of kinase), used antibodies, reaction temperature, and lysis and kinase buffers are mentioned in the appropriate paragraphs.

#### MAP-kinase assay:

To obtain activated MAP-kinases to perform *in vitro* kinase assays HEK293 cells were used. For p38 and JNK, the cells were deprived from FCS two hours before the specific stimulus was applied. In case of ERK kinase assay, the cells were starved over night. To activate MAPK pathways, the cells (sub-confluent 6 cm dishes) were stimulated with the following substances for the indicated time and final concentrations: p38 - 10 min anisomycin, [10 µg/ml]; ERK - 5 min, human epidermal growth factor (hEGF, [10 µg/ml]); JNK - 7 min, tumor necrosis factor  $\alpha$  (TNF $\alpha$ , [10 ng/ml]). After stimulation the cells were immediately lysed in 400 µl MAPK lysis buffer (see below) on the dish on ice. The lysed cells were harvested with a rubber policeman and transferred to an Eppendorf tube. Lysis was completed by incubation for 20 min on ice before the lysate was centrifuged (15 min, 4 °C, 13000 rpm, Eppendorf centrifuge) to remove insoluble cell debris. The different MAPK were immunoprecipitated (see paragraph immunoprecipitation) using 20 µl protein-G sepharose (Amersham Pharmacia Biotech) with 1 µl (= 200 ng) per tube of the following antibodies.  $\alpha$ -JNK (sc-474);  $\alpha$ -p38 (sc-535)  $\alpha$ -ERK (sc-154) (all [200 µg/ml]; Santa Cruz Biotech). The antibody-protein-G sepharose-bound kinases were washed 3 times with 1xPBS, 1% NP-40, once with Tris/LiCl (0.5 M LiCl, 100 mM Tris/HCl pH 7.5) and once in MAP-kinase buffer (see below). After the last washing step 2 µg of the different substrates were added to the sepharose-bound kinases. Known substrates of the three kinases were used as positive controls (JNK- GST-c-Jun (C-terminal deletion mutant); p38 - GST-ATF2; ERK - MBP (Sigma)). The kinase reaction was started by addition of a reaction mix ("kinase mix") containing 1.5 µl (= 50 µM) non-radioactive ATP (Stock 1 mM), 0.1 µl (= 1 µCi)  $^{32}$ P- $\gamma$ ATP (Stock: 10 µCi/µl) in a final volume of 30 µl MAP-kinase buffer. The reaction was incubated for 30 min at 30 °C and was stopped by addition of SDS loading buffer (see paragraph SDS-PAGE). After the SDS-PAGE gel run, the gel (10%) was dried and exposed to an X-ray film at -70 °C.

**MAPK-lysis buffer:**

20 mM Hepes pH 7.5  
10 mM EGTA  
40 mM  $\beta$ -glycero phosphate  
1% NP-40  
2.5 mM  $\text{MgCl}_2$   
2 mM orto-vanadate  
1 mM DTT  
1 mM PMSF  
10 ng/ml leupeptin  
10 ng/ml aprotinin

**MAP-kinase buffer:**

12.5 mM MOPS pH 7.5  
12.5 mM  $\beta$ -glycero phosphate  
7.5 mM  $\text{MgCl}_2$   
0.5 mM EGTA  
0.5 mM orto-vanadate  
100 mM DTT

**MLK2 -kinase assay:**

To carry out the MLK2 kinase assay HEK293 cells were transfected calcium phosphate-method; see 4.2.9) with 3  $\mu\text{g}$  of p-myc-MLK2 per sub-confluent 6 cm dish. The stimulation of MLK2 with anisomycin (10 min, [10  $\mu\text{g}/\text{ml}$ ]) was applied to fully induce MLK2, although overexpressed MLK2 is considered constitutively active (Nagata *et al.*, 1998). two days after transfection the cells were lysed in 400  $\mu\text{l}$  of MLK2-lysis buffer (see below) and the active kinase was immunoprecipitated using 8  $\mu\text{l}$  of 9E10-myc-tag antibody (9E10-hybridoma supernatant; Evan *et al.*, 1985). The immunoprecipitate was washed as described in the MAP-kinase assay but the last washing step, as well as the kinase reaction was done with MLK2-kinase buffer (see below). The kinase reaction (30 min, 37  $^\circ\text{C}$ ) was carried out in presence of 60  $\mu\text{M}$  non-radioactive ATP and 2  $\mu\text{Ci}$   $^{32}\text{P}$ - $\gamma\text{ATP}$  in the kinase mix. Two  $\mu\text{g}$  of recombinant thrombine-digested and purified SEK1-KD (SEK1 dead kinase mutant), a known substrate of MLK2 (Hirai *et al.*, 1997) served as positive control.

**MLK2-lysis buffer:**

20 mM Hepes pH 7.5  
150 mM NaCl  
10% glycerol  
1% Triton X-100  
1 mM EGTA  
1.5 mM  $\text{MgCl}_2$   
1 mM PMSF  
10 ng/ml leupeptin  
10 ng/ml aprotinin

**MLK2-kinase buffer:**

25 mM Hepes pH 7.5  
100 mM NaCl  
10 mM  $\text{MgCl}_2$   
5 mM  $\text{MnCl}_2$   
10% glycerol  
100  $\mu\text{M}$  orto-vanadate

p34cdc2-kinase assay:

These kinase assays were performed using HeLa cells. Not as a stimulus, but to enrich active p34cdc2-cyclin kinase complexes the cells were treated or not over night with nocodazol ([50 ng/ml]), arresting cell cycle in late mitosis (Krek and DeCaprio, 1995). Mitotic HeLa cells have a round morphology and easily detach from the cell culture dish. The mitotic cells thus were harvested by *mitotic shake-off* (Krek and DeCaprio, 1995) and by centrifugation before lysis with 400  $\mu$ l cdc2-lysis buffer (see below) on the dish on ice. Immunoprecipitations of the Cdk1 kinase complex were performed as described previously (see paragraph immunoprecipitation) with 5  $\mu$ l of anti-cdc2 antibody (Rab4; Paul Nurse lab), 1  $\mu$ l anti-Cyclin A (sc-596; Santa Cruz Biotech) or 8  $\mu$ l anti-Cyclin B antibody (191; J.C. Labbe Lab (CNRS, Montpellier)), respectively. As unknown substrate for p34cdc2 kinase reaction served a purified histone fraction (Sigma). The kinase reaction (30 min, 37 °C) was carried out in presence of 50  $\mu$ M non-radioactive ATP and with 2  $\mu$ Ci  $^{32}$ P- $\gamma$ ATP in the kinase mix. An additional purification step was done in these assays. After the kinase reaction, the reaction mixtures except the positive controls (SEK-KD) were filled up to 150  $\mu$ l with cdc2-kinase buffer, mixed well, centrifuged and the supernatant was transferred to new tubes. This step was repeated 3 times and the supernatants were combined. Then the GST-fused substrates were re-purified from these solutions using 20  $\mu$ l glutathion sepharose 4B analogously to a GST-pulldown assay rocking at RT for 30 min. The glutathion sepharose beads were washed 3 times in PBS and were denatured for 3 min at 100 °C in SDS loading buffer. P34cdc2-kinase reactions were separated in a 10% SDS-PAGE gel, dried and exposed to X-ray films.

**cdc2-lysis buffer:**

20 mM Tris/HCl pH 7.4  
100 mM NaCl  
1% Triton X-100  
10 mM EGTA  
10 mM EDTA  
40 mM  $\beta$ -glycero phosphate  
2 mM orto-vanadate  
1 mM PMSF  
10 ng/ml leupeptin  
10 ng/ml aprotinin

**cdc2-kinase buffer:**

25 mM Tris/HCl pH 7.5  
10 mM MgCl<sub>2</sub>  
1 mM DTT

### GST-pulldown kinase assay

This assay is a combination of GST-pulldown and *in vitro* kinase assay and was carried out with the purpose to demonstrate that Alien protein isoforms bind to an up to date unknown kinase activity for which they are substrate.

To perform this assay, raw extracts of equal numbers of growing or confluent cells lysed with 300  $\mu$ l of MAP-kinase assay lysis buffer (as described in paragraph MAP-kinase assay) were incubated for 2 h rocking at 4 °C with 10  $\mu$ g of bacterially expressed and purified GST, GST-Alien $\alpha$  and GST-Alien $\beta$  and 30  $\mu$ l glutathion sepharose 4B beads. The samples were centrifuged (1 min, 4°C, 300 rpm, Eppendorf centrifuge) and an *in vitro* kinase assay was performed with the pellets in absence of additional substrate in cdc2-kinase buffer with 100  $\mu$ M non-radioactive ATP and with 5  $\mu$ Ci  $^{32}$ P- $\gamma$ ATP (for processing see previous chapter). As a control, the same kinase assay was carried out with bacterially expressed and purified GST, GST-Alien $\alpha$  and GST-Alien $\beta$  and without previous incubation with cell extract to rule out that Alien protein isoforms harbor intrinsic kinase activity.

### In gel kinase assay

This assay is thought to identify the number and the approximate molecular weights of protein kinases that phosphorylate a given substrate. The substrate to investigate is co-polymerized with acrylamide in a denaturalizing gel and so immobilized during gel run. In these experiments GST-Alien $\beta$  and independently GST was chosen, because the Alien $\beta$  amino acid sequence contains the entire Alien $\alpha$  sequence. Separate gels containing 19  $\mu$ g/ml gel of bacterially expressed and purified GST and 18  $\mu$ g/ml gel GST-Alien $\beta$  were co-polymerized. HEK293 cells were treated with different extra cellular stimuli ("-FCS" = no stimulus; "+FCS" = FCS 1:100 for 10 min; anisomycin = 10  $\mu$ g/ml for 30 min; forskolin = 10  $\mu$ M for 30 min; UV = 60 J/m<sup>2</sup> ultraviolet light (Stratalinker; Stratagene), lysis after 15 min) and were lysed in MAP-kinase lysis buffer on the dish on ice. The lysis was completed for 30 min on ice in Eppendorf tubes and the extracts were separated from cell debris by centrifugation (15 min, 4 °C, 13000 rpm, Eppendorf centrifuge). The protein concentrations were measured and 30  $\mu$ g of these total protein extracts were separated on the substrate carrying gels.

After the gel runs the gels were washed under agitation twice for 30 min in 20% isopropanol, 50 mM Tris/HCl pH 8.0 (each time 50 ml), at room temperature. Then the

gels were washed twice for 30 min at RT in a solution containing 5 mM  $\beta$ -mercapto ethanol and 50 mM Tris/HCl pH 8.0 (each time 125 ml). After that, the proteins in the gels were denaturalized by washing twice for 30 min at RT in 6 M guanidinium/HCl, 5 mM  $\beta$ -mercaptoethanol, 50 mM Tris/HCl pH 8.0 (each time 50 ml). Re-naturalization was preformed by washing the gels for 24 h (o/n) in 5 mM  $\beta$ -mercaptoethanol, 50 mM Tris/HCl pH 8.0, 0.04% NP-40 at 4 °C changing the washing buffer about 4 times. The next day the gels were incubated under agitation for 30 min at RT in *in-gel*-kinase buffer without ATP (40 mM Hepes pH 8.0, 2 mM DTT, 0.1 mM EGTA, 5 mM MgAc, 5 mM MnAc). The kinase reaction was performed for 1 h under agitation at 37 °C (warm room) in a total volume of 3 ml *in-gel*-kinase buffer per gel containing 100  $\mu$ M non-radioactive ATP and 100  $\mu$ Ci  $^{32}$ P- $\gamma$ ATP in small double-sealed plastic bags. The high concentration of non-radioactive ATP (100  $\mu$ M) was chosen, because most protein kinases tend to auto-phosphorylate at lower ATP concentrations. Thereafter, to precipitate the proteins in the gel and to remove non-bound  $^{32}$ P- $\gamma$ ATP the gels were washed for 12-15 h in abundant 5% TCA, 1% sodium pyrophosphate changing the washing solution every hour until nearly no radioactive background could be detected with the Geiger counter. Then the gels were dried for 4 h at 65 °C in a vacuum gel dryer and exposed to X-ray films.

The radioactive signal(s) are expected to appear where kinase(s) and substrate coincides in the gel. Since the substrates were immobilized all over the respective gels, obtained radioactive signals locate where kinase proteins have migrated during electrophoresis. Therefore, the location indicates the approximate molecular weight of these proteins. Appearance of several signals indicates the existence of several specific kinases.

#### **4.2.9 Eukaryotic cell culture**

##### Storage and recovery of eukaryotic cells

Eukaryotic cells were stored in aliquots of approximately  $2 \times 10^7$  cells in medium supplemented with 10% DMSO in liquid nitrogen. Thereafter, the cells were harvested using trypsin, centrifuged (10 min, 1000 rpm, RT), resuspended in freezing medium containing DMSO and transferred to a cryo tube. Freezing was done slowly in an isolated cell freezer at -70 °C over night. The next day the cells were stored in liquid nitrogen. For cell recovery, an aliquot of such cells was rapidly thawed at 37 °C and

seeded on a 10 cm cell culture dish with abundant medium. 6-8 h after seeding the medium was changed.

#### Manipulation of cultured cells

All cell lines were grown at 37 °C in a CO<sub>2</sub>-incubator with humidified atmosphere in the required media supplemented with penicillin/streptomycin-solution (Gibco). Manipulation of the cells was exclusively performed in a sterile work bench and all buffers and media were pre-warmed to 37 °C before usage. The cell lines were mostly maintained in exponential cell growth. Depending on cell density, the cells were splitted to several other cell culture dishes in ratios of 1:3 to 1:8. The cells were detached from the dishes using trypsin solution (Gibco) and were resuspended in PBS, diluted and seeded again as necessary.

#### Transient transfection of eukaryotic cells

All cell lines used in this work were transfected using the Calcium phosphate method (Graham and van der Eb, 1973). Before transfection, 0.8 -1.4 x 10<sup>6</sup> cells of the different cell lines were seeded on 6 cm dishes to obtain cultures with 70-80% confluence in the moment of transfection. Equal quantities of DNA were diluted in 20 µl TE and mixed with 380 µl ice-cold CC-mix (or C-mix for HEK293 cells, see below). This solution was mixed quickly but completely with 420 µl ice-cold 2 x HBS (see below) and stored on ice for 30 min. After this incubation the transfection mixture was homogeneously applied drop by drop on the cell culture dish to transfect. The next day the medium was changed and the cells were incubated 24 h more until cell harvesting.

<u>C-Mix</u>		<u>2 x HBS-buffer</u>	
0.87 mM	Tris/HCl, pH 8	280 mM	NaCl
0.09 mM	EDTA	50 mM	Hepes
260 mM	CaCl <sub>2</sub>	1.5 mM	1.5 mM Na <sub>2</sub> HPO <sub>4</sub>
		pH 7,12 (exactly)	
for CC-Mix	add		
32.6 µg/ml	sheared ssDNA		

#### Measurement of luciferase activity

In transient reporter gene assays, the enzyme luciferase is transcribed from the co-transfected LUC reporter gene. The luciferase activity is directly proportional to the gene activity of the LUC-attached promoter. The luciferase activity is measured by



enzymatic reaction with its substrate luciferin in presence of ATP. Thereby, the enzymatic oxidation emits light that can be quantified in a luminometer. The output is relative LUC units.

To obtain the luciferase transcribed from the reporter gene; adequately transfected cells are washed once with PBS and are lysed in LUC-lysis buffer (see below) on the dish. The cells are harvested using a rubber policeman and the lysis is completed on ice during 30 min. The lysates are centrifuged (15 min, 13000 rpm, 4 °C, Eppendorf centrifuge), the protein concentration is determined and 100 µl extract are measured for luciferase activity. Therefore, 100 µl of the lysate is transferred to a luciferase tube containing 300 µl LUC-lysis buffer. 100 µl luciferin solution are added immediately before measurement in the luminometer for 10-30 sec.

<u>LUC-lysis buffer:</u>	25 mM	Tris/HCl, pH 7.5	<u>Luciferin-solution:</u>	90	mg/ml	D-luciferin
	8 mM	MgCl <sub>2</sub>		0.8	mM	ATP
	1 mM	EDTA				
	1 %	Triton X-100				
	15 %	Glycerol				
(freshly added):	1 mM	DTT				
	0.2 mM	PMSF				

#### Measurement of β-galactosidase activity

β-gal activity from lysates of eukaryotic cells was measured analogously to the procedure described in chapter 4.2.11 during the yeast-two-hybrid assay in Z-buffer.

#### In vivo labeling with <sup>32</sup>P-phosphorus

For *in vivo* labeling of Alien proteins equal amounts of HA-tagged Alien expression plasmids (pHA-Alien $\alpha$ ; pMT2-chAlien $\beta$ ) and empty HA-vector (pHA-linker) were transfected into HEK293 cells. The next day the medium was changed to phosphate and serum-free medium (Gibco) and the cells were incubated over night. The next day 0.6 mCi <sup>32</sup>P-phosphorus were added to each dish and the cells were incubated again for 5 hours. Thereafter, the cells were washed twice in PBS and lysed in lysis buffer (50 mM Tris/HCl pH 7.4, 100 mM NaCl, 5mM CaCl<sub>2</sub>, 5 mM MgCl<sub>2</sub>, 1% NP-40, 1% Triton X-100, 1 mM PMSF, 10 ng/ml leupeptin, 10 ng/ml aprotinin). Then the HA-tagged Alien proteins were immunoprecipitated using an anti HA antibody (4.2.8). The immunoprecipitated proteins were separated by SDS-PAGE, the gel was dried and the radioactively labeled proteins were visualized by autoradiography.

### Synchronization of eukaryotic cells – Flow cytometry

To stop HeLa cells in different cell cycle stages, the cells were submitted to different treatments as described in Krek *et al.* (Krek and DeCaprio, 1995). For these assays, two equal 80% confluent 10 cm dishes were used for each cell cycle phase. One dish of each duplicate was fractionated in nuclear and cytoplasmic extracts for Western blot analysis, and the other one was ethanol-fixed for FAC-Scan analysis as described below

#### Mitosis:

To stop HeLa cells in mitosis they were treated 16-18 h with 50 ng/ml nocodazol. The cells present a round morphology in mitosis. Mitotic cells were detached by *mitotic shake-off*, harvested by centrifugation (10 min. 1000 rpm, RT) from the medium.

#### G1-phase:

HeLa cells were synchronized in G1-phase by mimosine treatment (0.5 mM, for 24 h). Mimosine stops the cells in late G1-phase.

#### G1/S-phase:

Treatment of the HeLa cells with hydroxy urea (2mM, over night) accumulates cells at the G1/S-border of the cell cycle.

#### S-phase / G2 phase:

To stop HeLa cells in S-phase, the cells were submitted to thymidine shock (2.5 mM over night). The cells were then washed twice with PBS to remove the thymidine and release the cell cycle block and normal medium was applied. After growth of the cells for 2 h the S-phase was reached, after 8 h release the cells were in G2-phase.

### Fixation and FAC-Scan analysis

To assay cell cycle progression, the cells were harvested and ethanol-fixed. Thereafter, the medium was recollected and centrifuged (5 min, 2500 rpm, RT) to obtain detached apoptotic cells. The rest of the cells was harvested using trypsin and centrifuged as above. The two cell pellets were pooled and the resulting pellet was washed twice in PBS. To fix the cells, 1 ml of ice-cold 70% ethanol (-20 °C) was added slowly, the cells were resuspended carefully and the probes were incubated for 15-30 min on ice. After that, the cells were spun down (pulse) and washed again once in PBS, resuspended in

200  $\mu$ l PBS and treated for 30 min at 37 °C with 1  $\mu$ l RNase-A (10  $\mu$ g/ $\mu$ l). Then, DNA was stained with 50  $\mu$ g propidium iodide (10  $\mu$ g/ $\mu$ l) and fluorescent labeling was evaluated using a FAC-Scan equipped with Cell Quest Software (Becton Dickinson).

#### Fractionation of cells in nuclear and cytoplasmic extracts

(modified from Dignam *et al.*, 1983)

The cells were washed twice with ice-cold PBS and harvested in PBS, centrifuged (5 min, 4°C, 3000 rpm) and the cell pellet was resuspended and lysed in 400 $\mu$ l in NPBT-lysis buffer for 10 min on ice. The lysate was placed carefully on 400  $\mu$ l of 50% (w/v) sucrose in NPB-buffer in a new tube and was centrifuged for 10 min at 4 °C at 13000 rpm. The resulting supernatant is the cytosolic extract and was stored in a new tube at -70 °C. The inter-phase contains cell debris and the pellet the nuclei. All the supernatants (inter-phase and liquid phase) were removed and to the pellet containing the nuclei 1 ml of NPB was added without resuspending the pellet. It was centrifuged again as above and the supernatant was discarded. Now, the nuclei were lysed in 50-80  $\mu$ l of DgC-buffer and lysed for 30 min on ice moving carefully from time to time. After centrifugation as above, the supernatant containing the nuclear extract was stored in a new tube at -70 °C.

##### **NPB-buffer**

10 mM Tris/HCl pH 7.4  
140 mM NaCl  
2 mM MgCl<sub>2</sub>  
20 mM  $\beta$ -glycero phosphate  
1 mM PMSF  
10 ng/ml leupeptin  
10 ng/ml aprotinin

##### **NPBT-buffer**

same as NPB + 0.1% Triton X-100

##### **DgC-buffer**

20 mM Hepes pH 7.9  
420 mM NaCl  
1.5 mM MgCl<sub>2</sub>  
0.2 mM EDTA  
20 mM  $\beta$ -glycero phosphate  
1 mM PMSF  
10 ng/ml leupeptin  
10 ng/ml aprotinin

#### **4.2.10 *In situ* hybridization**

##### **Induction of hypothyroidism in rats**

To induce fetal and neonatal hypothyroidism in rats, 2-mercapto-1-methylimidazole (0.02 %, Sigma Chemical Co., St Louis, Mo) was administered in the drinking water of the dams from the 9th day after conception and was continued until the animals were killed. In addition, surgical thyroidectomy was performed (by the technician M. Gonzalez) at P5 as described previously (Muñoz *et al.*, 1991). This protocol ensures that the animals are hypothyroid during the entire neonatal period (Alvarez-Dolado *et al.*,

1998). P0 animals were killed 8-12 hours after birth. T4 was used for the *in vivo* hormonal treatments because it crosses the blood-brain barrier more efficiently than T3, and is converted to T3 in the brain (Dickson *et al.*, 1987). T4 was administered as single daily intraperitoneal injections of 1.8 µg/100 g body weight starting four days before death. Rats were killed 24 h after the last T4 injection. Hypothyroid animals showed an arrest of body weight growth (25% on P15) and low circulating levels of both T4 and T3 (Morreale de Escobar *et al.*, 1985). For *in situ* hybridization studies, at least three animals were studied per experimental group to obtain representative values.

#### Preparation of radioactive-labeled riboprobe:

Anti-sense hAlien riboprobe was obtained by T7 RNA polymerase (Promega) synthesis in presence of 50 µCi of <sup>35</sup>S-UTP using the pT7-asAlien<sub>419</sub>-SP6 vector. For sense riboprobe synthesis SP6 RNA polymerase (Boehringer Mannheim) was used. Riboprobes were purified by centrifugation through Chroma Spin-100 DEPC-H<sub>2</sub>O columns (Clontech).

#### In situ hybridization

*In situ* hybridization on floating sections was performed as adapted from the procedure of Gall and Isackson (Gall and Isackson, 1989). Under profound ketamin/pentobarbital anesthesia, normal and hypothyroid rats of different ages were perfused through the heart with cold 4% p-formaldehyde in 0.1 M sodium phosphate (pH 7.4). The brains were removed quickly, post fixed in 4% p-formaldehyde in 0.1 M sodium phosphate (pH 7.4) and cryoprotected in 4% p-formaldehyde + 30% sucrose (w/v) in phosphate buffer saline (PBS) at 4 °C. Subsequently, 25 µm thick coronal sections were cut using a cryostat. Sections were thawed, washed with PBS for 5 min and treated for additional 10 min at room temperature under free-floating conditions with 0.1% Triton X-100, 0.2 M hydrochloric acid, 0.25% acetic anhydride in 0.1 M triethanolamine, and post fixed with 4% p-formaldehyde. They were then pre-incubated in hybridization solution (0.6 M sodium chloride, 20 mM piperazine-N,N'-bis(2-ethanesulfonic acid) (PIPES)-sodium salt pH 6.8, 10 mM ethylenediaminetetra-acetate (EDTA) 50% formamide, 0.2% SDS, 5x Denhardt's solution, 10% dextran sulfate, 50mM dithiotreitol, 250 µg/ml of sheared salmon sperm DNA and 250 µg/ml of yeast tRNA) for 3-5 hours at 55 °C, and then incubated in the same solution containing the <sup>35</sup>S-UTP-labeled riboprobe (1.6

x  $10^7$  cpm/ml) overnight at 55°C. Sections were consecutively washed once in 2 x standard saline citrate (SSC: 1 x SSC = 0.15 M sodium chloride, 0.015 M sodium citrate) + 10 mM  $\beta$ -mercaptoethanol at RT for 30 min, once in 5 x TEN (50 mM Tris/HCl pH 7.5, 5 mM EDTA, 0.5 M NaCl) supplemented with 4  $\mu$ g/ml RNase-A at 37 °C for 1 h, twice in 0.5 x SSC + 50% formamide + 10 mM  $\beta$ -mercaptoethanol at 55 °C for 1 h, once in 0.1 x SSC + 10 mM  $\beta$ -mercaptoethanol at 68 °C for 1 h, and finally, twice in PBS at RT for 5 min. Sections were mounted onto slides, dehydrated by ethanol series (containing 0.3 M ammonium acetate), exposed for 21 days to Hyperfilm  $\beta$ -MAX films (Amersham Pharmacia Biotech), developed with Kodak D19 and fixed. To determine specificity and background of riboprobe hybridization a representative amount of brain sections of each age and treatment was hybridized with Alien sense riboprobe following the above described protocol. After exposure of *in situ* hybridizations, the mounted sections were Nissl stained with a 0.1% solution of toluidine-blue using standard techniques, to visualize brain regions. For anatomical abbreviations, those in Swanson were applied (Swanson, 1992).

#### **4.2.11 Manipulation of yeast**

##### Growth and storage

The yeast cells (EGY48 strain) were grown at 30 °C under agitation in YPD medium (10 g/l yeast extract, 20 g/l bactopecton, 20 g/l glucose in H<sub>2</sub>O) or on solid YPD dishes (YPD medium + 20 g/l agar on Petri plates at 30 °C. The EGY48 strain was short time stored on YPG plates at 4 °C or for long time in YPD supplemented with 15% glycerol solution in at -70 °C. All working steps were done with sterile material and solutions. For all washing steps, sterile water was used if indicated.

##### Production of competent yeasts and transformation

Transformation-competent EGY48 were produced using the LiAc / ssDNA / PEG method (Gerstel *et al.*, 1992; Vreken *et al.*, 1992). The subsequent transformation of the obtained competent yeast cells was done following the method described in Johnsten's book (Johnsten, 1994).

50 ml of a YPD culture of EGY48 were grown over night to the stationary phase. The next day the culture was diluted 1:20 in 100 ml pre-warmed YPD and grown at 30 °C to

a  $OD_{600}$  of  $\leq 1$  ( $\approx 2 \times 10^7$  cells/ml). The 100 ml yeast culture was separated in two 50 ml portions and the following steps were performed in duplicate. The yeasts were harvested by centrifugation (5 min, 3500 rpm, RT), washed with 40 ml sterile water and centrifuged again. The yeast pellet was resuspended in 1 ml water and transferred into a 1.5 ml Eppendorf tube, spun down for 10 sec at full speed and the pellet was resuspended in 1 ml 100 mM LiAc (Stock 1M in Tris/HCl pH 7.5), incubated for 15 min at 30 °C in a water bath. 40  $\mu$ l of this suspension were used per transformation reaction. Then, 1  $\mu$ l of each plasmid DNA ( $\approx 200$ ng) together with 5  $\mu$ l denatured sheared salmon sperm DNA were added per reaction and mixed with 300  $\mu$ l PEG/LiAc solution (500  $\mu$ l LiAc, 500  $\mu$ l H<sub>2</sub>O, 4 ml PEG-3350 50% (w/v)) with a pipette. The transformation was incubated for 30 min at 30 °C. The transformation was heat-shocked for 20 min at 42 °C. After that, the reactions were spun down, the PEG/LiAc solution was removed and the yeast cells were washed twice with 1 ml water before plating them in a volume of 100  $\mu$ l water on SD/GM-UTH-plates (selection plates; see below). Recombinant yeast cells were grown for 3 days at 30 °C.

SD/GM-UTH-Platten:

20 g agar, 20 g glucose, 1,8 g YNB,  
2,5 g ammonium sulfate filled up to 950ml with H<sub>2</sub>O,  
autoclave (20 min, 121°C), cool down to approx. 60 °C,  
add 50ml 10x gold medium, plate on Petri dishes, storage at 4°C.

Gold medium 10x:

0.3 mg/ml adenine, 0.3 mg/ml arginine, 1 mg/ml aspartic acid,  
0.2 mg/ml iso-leucine, 0.4 mg/ml leucine, 0.4 mg/ml lysine, 0.2 mg/ml  
methionine, 0.5 mg/ml phenylalanine, 1.5 mg/ml threonine, 0.2 mg/ml  
tyrosine, 0.65 mg/ml valine, fill up to 1 l with H<sub>2</sub>O, dissolve well, filter sterile,  
store at 4°C. All amino acids are the L-forms.

Yeast-two hybrid assay (liquid  $\beta$ -gal assay)

From the selection plates carrying the recombinant yeast colonies two pools composed of three colonies from the same plate (duplicated samples) were picked and grown o/n in 5 ml SD/GM-UTH medium (see above, without agar) up to a  $OD^{600}$  of approximately 1 ( $\approx 5 \times 10^7$  cells/ml). Replacement of the glucose by galactose in the culture medium induces the GAL-1 promoter of the plasmids used here (see yeast expression plasmids, chapter 5.1.3 and 4.1.16; Johnsten, 1994). Thereafter, 500-700  $\mu$ l ( $\approx 5 \times 10^7$  cells) of well resuspended over night cultures were transferred to Eppendorf tubes, centrifuged and washed twice with water to remove the glucose. These yeast cells were grown o/n at 30 °C in 5 ml SGR/GM-UTH selection medium (40 g galactose, 1.8 g YNB, 5 g

ammonium sulfate in 950 ml H<sub>2</sub>O, autoclaved and supplemented with 50 ml gold medium when cold, containing galactose).

The next day the OD<sub>600</sub> of each culture was measured and volumens containing 1.5 - 3.5 x 10<sup>7</sup> yeast cells were placed in 2 ml tubes. The cells were centrifuged, the supernatant was removed and the pellet was resuspended in 2 ml Z-buffer (16.1 g/l Na<sub>2</sub>HPO<sub>4</sub> x 7 H<sub>2</sub>O, 5.5 g/l NaH<sub>2</sub>PO<sub>4</sub> x H<sub>2</sub>O, 0.75 g/l KCl, 0.246 g/l MgSO<sub>4</sub> x 7 H<sub>2</sub>O, 2.7 ml β-mercapto ethanol, pH 7.0) and stored on ice. Now, 200 μl of this suspension were transferred to 2 ml tubes containing 800 μl Z-buffer. The yeast cells of this suspension were lysed by addition of 1 drop of 0.1% SDS and 2 drops of chloroform mixing extensively (25-20 sec) on a vortex. The lysates were pre-warmed at 30 °c for 15 min before the β-gal reaction was started by addition of 200 μl ONPG (4 mg/ml ONPG in 1x phosphate buffer (10x phosphate buffer (1M): 61.5 ml 1M K<sub>2</sub>HPO<sub>4</sub>, 38.5 ml KH<sub>2</sub>PO<sub>4</sub>). The start-time point was annotated and the reaction was performed in a water bath at 30 °C. A reaction containing all solutions but no yeast cells served as negative control. In case of yellow color reaction (β-gal-released o-nitro phenol), the reaction was stopped by addition of 500 μl of 1 M Na<sub>2</sub>CO<sub>3</sub> and the stop-time point was annotated. The samples that presented no color reaction were stopped after 8-9 hours. The samples were centrifuged (5 min, RT, 4000 rpm) and their absorption measured in a photometer at 420 nM (OD<sub>420</sub>). The β-gal activity (Miller Units) was calculated using the following formula:

$$U = 1000 \times OD_{420} / t \times V \times OD_{600}$$

U = Miller Units; t = reaction time; V = volume yeast lysate (here 200 μl); OD<sub>600</sub> = OD of the Z-buffer suspension = cell density, OD<sub>420</sub> = absorption of the color reaction.

## 5. Results

The following chapter describes the characterization of the corepressor Alien $\alpha$  and its isoform Alien $\beta$  (CSN2).

This work deals first with the expression pattern of both Alien mRNA and proteins in rat tissues. Noteworthy, high Alien mRNA and protein expression was found in tissues of the rat central nervous system (CNS). One known function of Alien $\alpha$  is to act as a corepressor for the thyroid hormone receptor (Dressel *et al.*, 1999). Thyroid hormone is essential for brain maturation and the lack of T3 in hypothyroidism leads to severe alteration of expression of thyroid hormone regulated genes (Bernal, 2002). The rat hypothyroid brain is a well established model system for studies of T3-regulated genes (Bernal, 2002). Thus, it was investigated whether alien expression is altered in the hypothyroid rat brain. Therefore, *in situ* hybridization assays in normal and hypothyroid developing rat brains were performed, detecting a general down regulation of alien mRNA in absence of thyroid hormone. This regulation was characterized in more detail by studying the influence of T3 on Alien mRNA and protein expression in CNS derived cell lines.

The predicted amino acid sequences of the two Alien protein isoforms Alien $\alpha$  and Alien $\beta$  are identical in the N-terminal 305 residues (Goubeaud *et al.*, 1996; Seeger *et al.*, 1998; Dressel *et al.*, 1999; Schaefer *et al.*, 1999 and unpublished data). The only structural difference between these proteins is located in the C-terminal domain of Alien $\beta$  named PCI domain (Hofmann and Bucher, 1998), which is responsible for its integration in the COP9-signalosome (CSN; Freilich *et al.*, 1999; Kapelari *et al.*, 2000). The structural similarities of the two Alien isoforms raise the question, if both proteins share or differ in functional features. Interestingly, both proteins have been described to be involved in different processes (see introduction). Hence, functional aspects discovered for Alien $\alpha$  were compared to Alien $\beta$  and vice versa. Direct binding to known and novel Alien-interacting proteins was studied in GST-pulldown experiments and in the yeast-two-hybrid system. Furthermore, Alien $\alpha$  and Alien $\beta$  were compared in their silencing potential and their influence on AP1-, Rb- and E2F mediated transcription. These analyses suggested a possible role of post-transcriptional modification in Alien $\alpha$  and Alien $\beta$  function. Therefore, *in vivo* and *in vitro* phosphorylation studies were carried out.



## 5.1 Plasmid construction

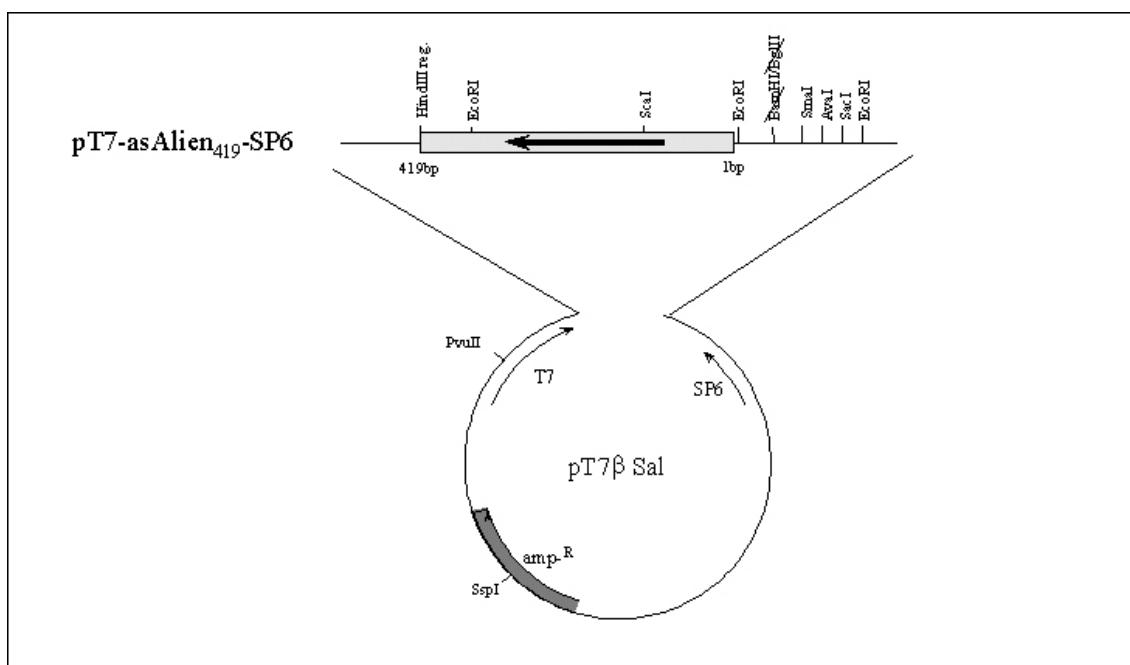
### 5.1.1 Remark

All used plasmids contain an origin of replication (*ori*), which is necessary for extra chromosomal replication in *E.coli*. In addition, all the plasmids include a resistance-gene coding for either the enzyme  $\beta$ -lactamase, or an amino-glycosid-transferase, causing resistance to ampicillin or kanamycin (amino-glycoside- type antibiotics) in transformed bacteria. Plasmids cloned or provided by other persons are listed in chapter 4.1.16.

### 5.1.2 Mammalian expression and *in vitro* transcription vectors

#### pT7-asAlien<sub>419</sub>-SP6

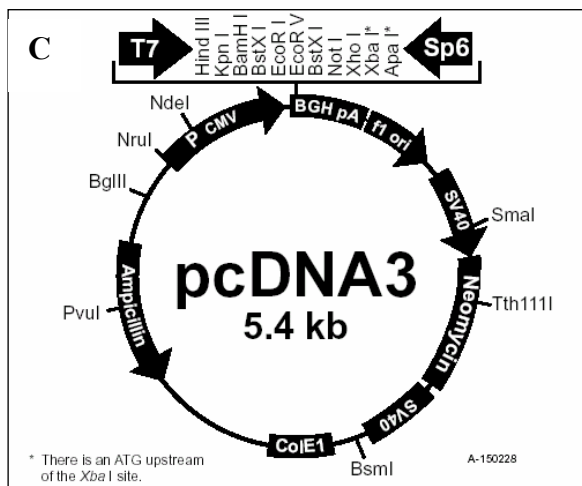
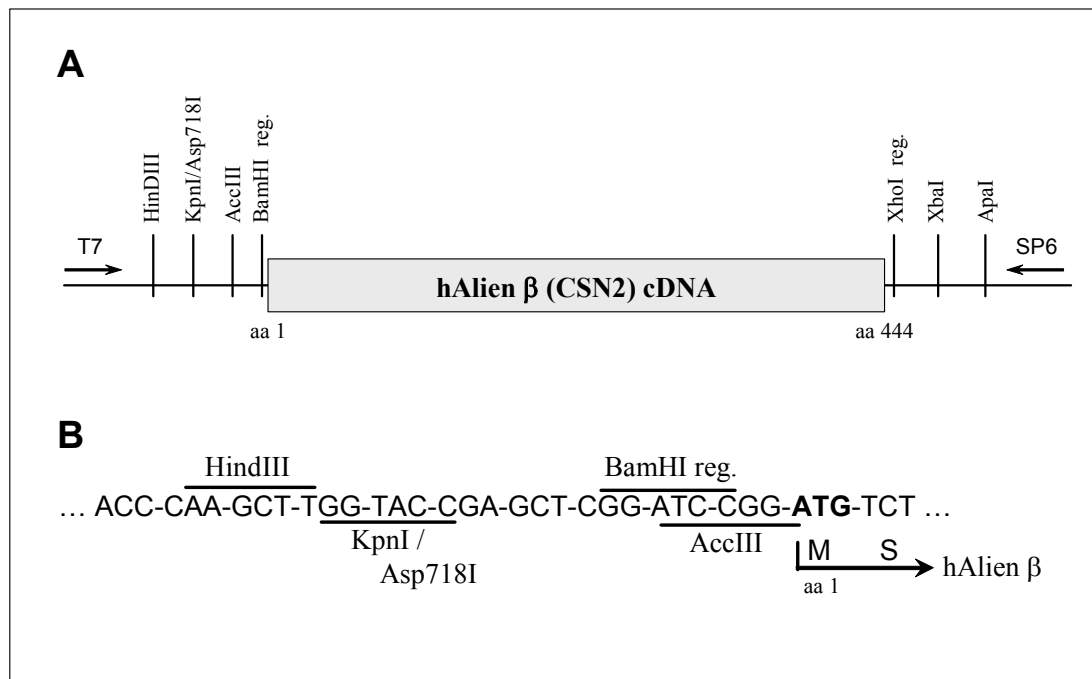
The *in vitro* transcription vector pT7-asAlien<sub>419</sub>-SP6 was constructed by insertion of the 419bp BglIII/HindIII fragment of pAB-hAlien (Dressel *et al.*, 1999) in antisense orientation into HindIII/BamHI sites of pT7 $\beta$ Sal. (Fig. 1; Norman *et al.*, 1988). This vector is suitable to produce antisense and sense riboprobes, encompassing the first 419 nucleotides of the alien cDNA, using T7- or SP6-RNA polymerases, respectively.



**Fig. 1: Schematic view of the pT7-asAlien<sub>419</sub>-SP6 *in vitro* transcription vector.** The circle symbolizes the plasmid, the upper part of the scheme the insert (grey box) in orientation of the big arrow. The numbers of first and last bp of the insert are indicated. The small curved arrows stand for the T7- and SP6-RNA-polymerase promoters as indicated. The ampicillin resistance ( $\beta$ -lactamase) gene is marked with amp<sup>R</sup>. Restriction sites are labeled ("reg" means regenerated) and destroyed ones are crossed out.

### pcDNA3-CSN2

The mammalian expression plasmid pcDNA3-CSN2 has been constructed by excision of hAlien  $\beta$  (CSN2) 1,6 kb cDNA from pcDNA3-flag-CSN2 (Naumann *et al.*, 1999) using the restriction enzymes BamHI and XhoI and ligation into a modified pcDNA3 vector (Fig.2 C, Invitrogene), previously cut with the same enzymes. Both restriction enzyme consensus sequences are regenerated ("reg." Fig. 2 A & B). A map of the backbone vector (pcDNA3; Invitrogene) is displayed in Fig. 2-C), as supplied by the manufacturer. pcDNA3-CSN2 serves for expression in mammalian cells as well as for *in vitro* transcription/translation using the present T7-RNA-polymerase promoter.

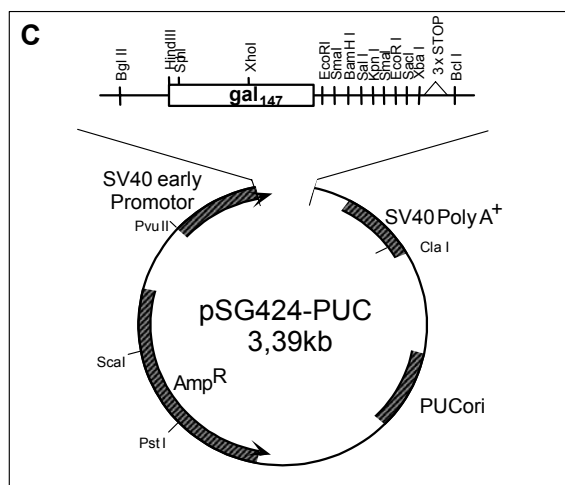
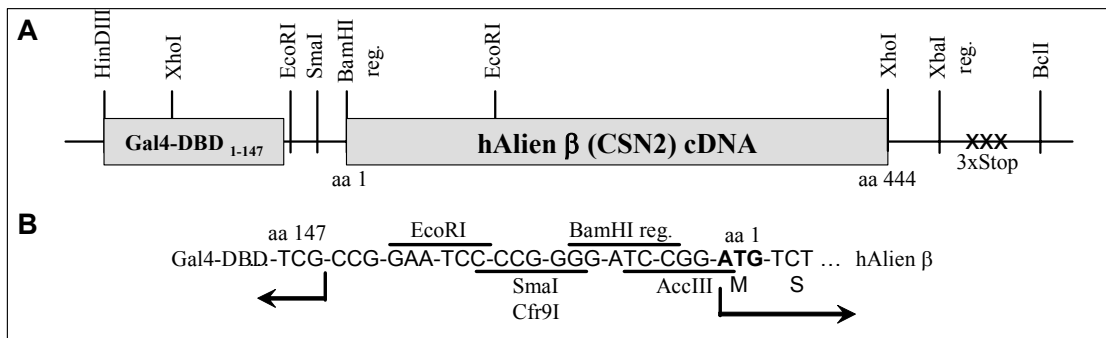


**Fig. 2:** Schematic representation of the hAlien $\beta$  (CSN2) cDNA (A), inserted in pcDNA-CSN2 as well as the resulting 5'-polylinker (B). The encoded amino acids (aa) and the remaining restriction enzyme sites are indicated ("reg." means regenerated). Arrows labeled with T7 and SP6 indicate the RNA-polymerase promoters (A). *In frame*-codons are separated by hyphens and the first two amino acids of hAlien $\beta$  are annotated in one letter code (B). (C). Vector map of pcDNA3, as provided by Invitrogene (<http://www.invitrogene.com>). The pcDNA3 vector used here was modified by *knocking out* the indicated BglII restriction site in the vector's backbone. This consisted in cutting BglII, *filling in* with Klenow enzyme and religation of the

vector. The plasmid contains the following elements: CMV promoter (bp 209-863); T7 promoter (bp 864-882); Polylinker (bp 889-994); Sp6 promoter (bp 999-1016); BGH poly A (bp 1018-1249); SV40 promoter (bp 1790-2115); SV40 origin of replication (bp 1984-2069); Neomycin ORF (bp 2151-2945); SV40 poly A (bp 3000-3372); ColE1 origin: (bp 3632-4305); Ampicillin ORF (bp 4450-5310), and the indicated restriction sites.

pSG424-PUC-CSN2

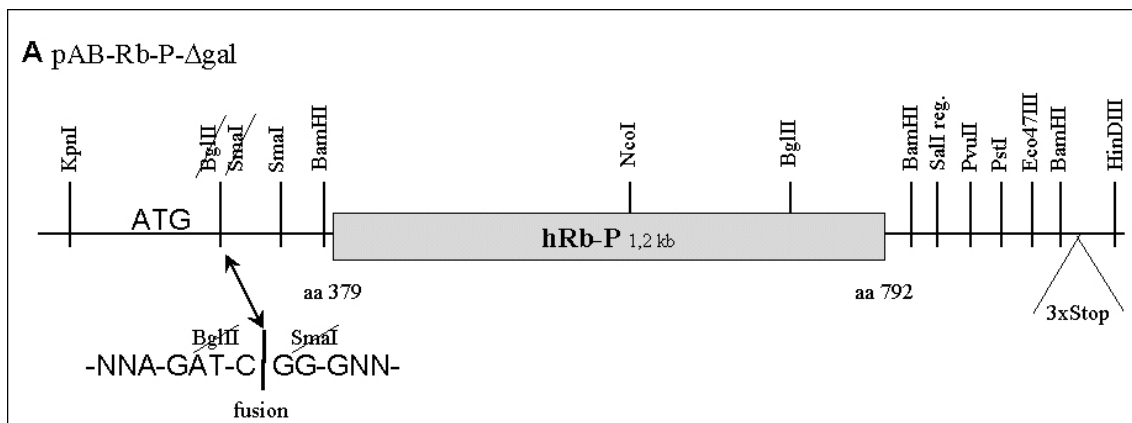
The plasmid pSG424-PUC-CSN2 (Fig. 3 A and B) was generated by *in frame* ligation of the 1,6 kb BamHI/XbaI fragment of pcDNA3-CSN2 (described above) into pSG424-PUC previously digested with the same restriction enzymes. The plasmid pSG424-PUC is a derivative of pSG424 (Sadowski and Ptashne, 1989) generated by C. Caelles in our laboratory, by replacing the original *low copy*-origin of replicaton (pBR322-ori) with the *high copy* ori of the PUC vector series (pUC-ori). The vector carries the DNA binding domain (DBD) of the yeast GAL4 protein (aa 1-147) followed by a multiple cloning site (Fig. 3 C) and was designed to clone GAL4-fusion proteins. pSG424-PUC-CSN2 codes for a chimeric Gal4-DBD-hAlienβ Protein, when transfected into mammalian cells.



**Fig. 3. Schematic view of the Gal4 fusion with hAlien β in pSG424-PUC-CSN2 (A) and the resulting sequence between the Gal4-DBD and the hAlien β cDNA, both symbolized by filled boxes (B). In frame codons are separated by hyphens. Positions of restriction sites (reg.=regenerated) and encoded amino acids (one-letter code) are labeled. xxx/3xStop indicates three stop codons in all possible frames. (C) Vector map of pSG424-PUC. The multiple cloning site and the symbolized gal4-DBD sequence coding for aa 1-147 (box; C) are shown. The Plasmid of 3.39kb contains the following elements: SV40 early promoter; Polylinker; SV40 poly A; PUC-origin of replication; Ampicillin ORF;**

### pAB-Rb-P $\Delta$ gal

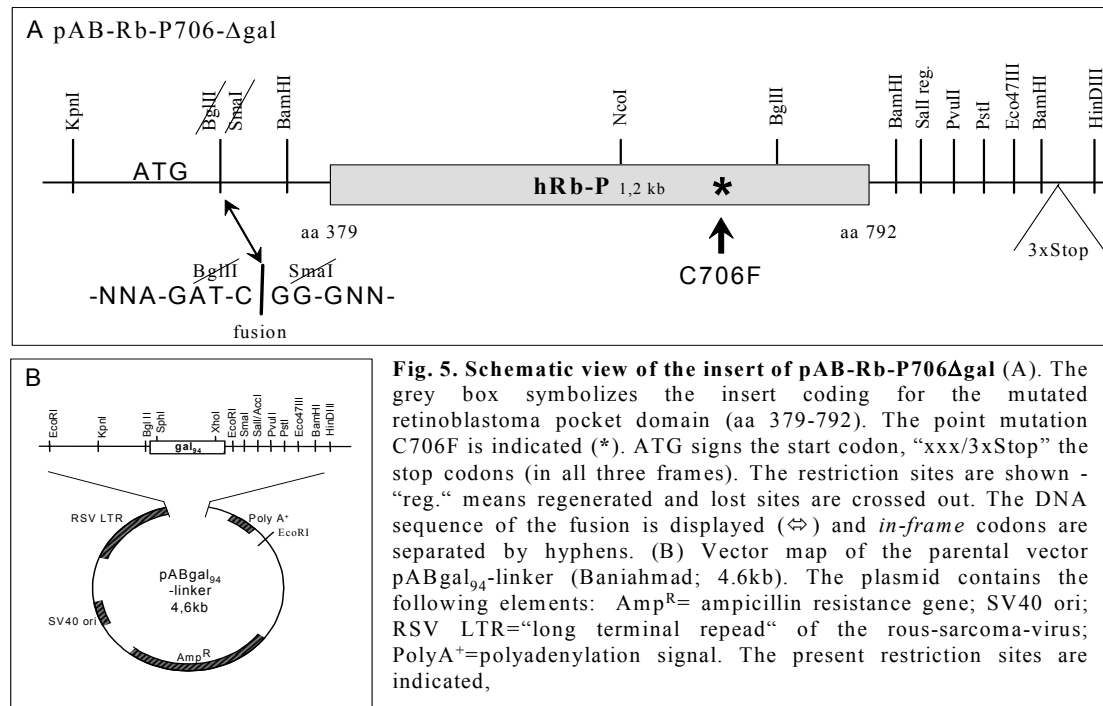
pAB-Rb-P $\Delta$ gal is a plasmid suitable to express the pocket domain (aa 379-972) of the human retinoblastoma protein (hRb) in mammalian cells. To clone this vector, the insert was liberated of from pM2-Rb-P (chapter 4.1.16) using SmaI and Sall. The vector pABgal-linker (Baniahmad) was cut with BglII, *filled-in* with Klenow enzyme and finally digested with Sall, thereby, the gal4-DBD sequence was lost. Ligation of vector and insert destroyed both BglII and SmaI sites (Fig. 4).



**Fig 4:** Schematic view of the insert of pAB-Rb-P $\Delta$ gal, encoding the amino acid residues 379-792 (as indicated) of the human retinoblastoma protein (pocket domain of hRb; grey box). "ATG" signs the start codon, 3xStop the stop codons (in all three frames). The present restriction sites are shown, regenerated ones are labeled with "reg.", and destroyed ones are crossed out. Furthermore, the DNA sequence of the fusion is displayed (arrow) and *in-frame* codons are separated by hyphens

### pAB-Rb-P706 $\Delta$ gal

pAB-Rb-P706 $\Delta$ gal is a mammalian expression plasmid, expressing the mutated (C706F) pocket domain (aa 379-972) of the human retinoblastoma protein (hRb) (Kaye *et al.*, 1990). For its construction, the insert was liberated of from pEG-Rb-P706\* (Altincicek) using SmaI and Sall. The vector pABgal-linker (Baniahmad) was cut with BglII, *filled-in* with Klenow enzyme and digested with Sall, there by, the gal4-DBD sequence was lost. Ligation of vector and insert destroyed both BglII and SmaI sites (Fig. 5).

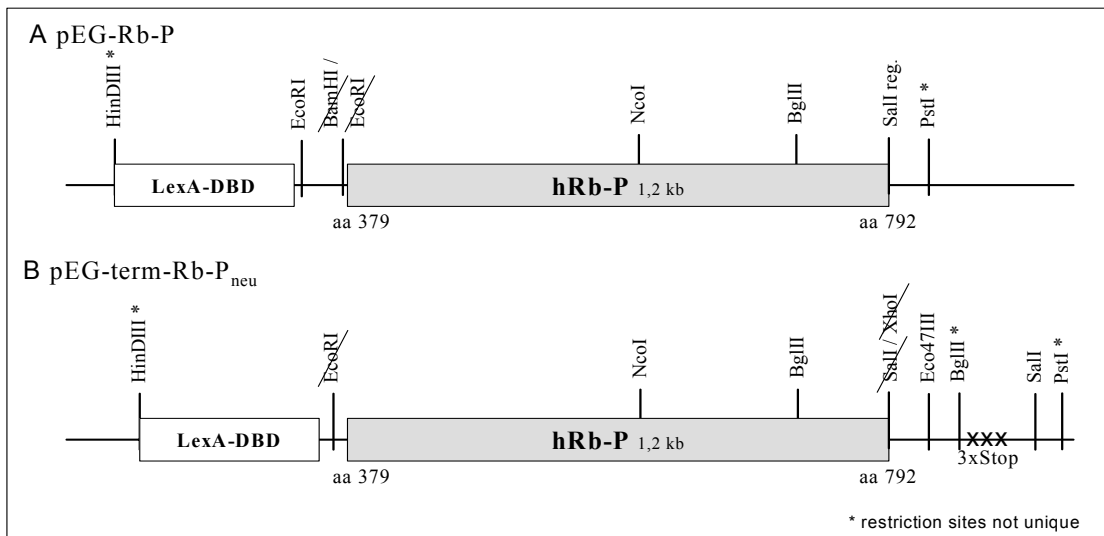


**Fig. 5. Schematic view of the insert of pAB-Rb-P706Δgal (A).** The grey box symbolizes the insert coding for the mutated retinoblastoma pocket domain (aa 379-792). The point mutation C706F is indicated (\*). ATG signs the start codon, “xxx/3xStop” the stop codons (in all three frames). The restriction sites are shown -“reg.” means regenerated and lost sites are crossed out. The DNA sequence of the fusion is displayed (↔) and *in-frame* codons are separated by hyphens. (B) Vector map of the parental vector pABgal<sub>94</sub>-linker (Baniahmad; 4.6kb). The plasmid contains the following elements: Amp<sup>R</sup>= ampicillin resistance gene; SV40 ori; RSV LTR=“long terminal repeat” of the rous-sarcoma-virus; PolyA<sup>+</sup>=polyadenylation signal. The present restriction sites are indicated,

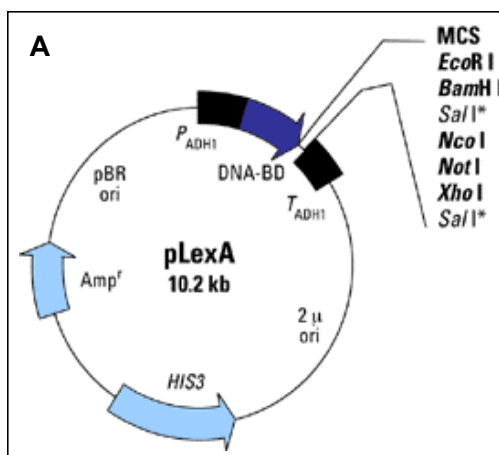
### 5.1.3 Yeast expression vectors

#### pEG-term-Rb-P<sub>neu</sub>

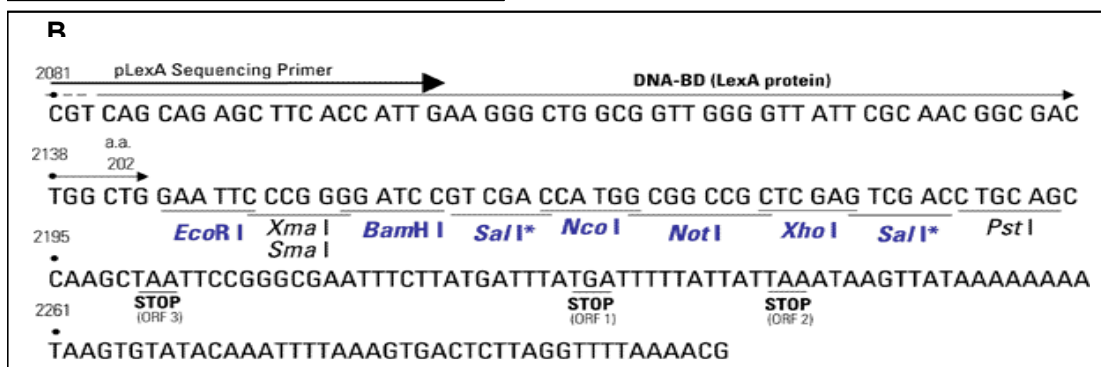
To construct the yeast expression plasmid pEG-term-Rb-P<sub>neu</sub> an intermediate plasmid pEG-Rb-P was cloned. The insert coding for the pocket domain (aa379-792) of human retinoblastoma protein (hRb) was derived from the plasmid pM2-Rb-P (Chapter 4.1.16). pM2-Rb-P was digested with EcoRI, sticky ends were filled in using Klenow enzyme, and the insert was finally liberated by SalI digestion. The obtained fragment was ligated in the dephosphorylated, linearized plasmid pEG-term (Thormeyer) presenting a 3' Klenow-blunted BamHI end and a 5' sticky SalI end (Fig. 6 A and B). The resulting intermediate vector pEG-Rb-P lacks viable 3'-stop codons. To obtain the final plasmid, the insert was liberated from the intermediate vector pEG-Rb-P by EcoRI digestion, *filling-in* of sticky ends (Klenow enzyme) and redigestion using SalI. This fragment was fused *in frame* to the LexA-DBD in pEG-term (Thormeyer) harboring a *Klenow-blunted* EcoRI and a sticky XhoI site, which is compatible with the SalI site of the insert. All three restriction sites are destroyed. The obtained vector pEG-Term-RB-P<sub>neu</sub> (Fig. 6 A and B) is suitable to express LexA-Rb-P chimera proteins in adequate yeast strains.



**Fig. 6. Schematic view of the inserts of the plasmids pEG-Rb-P (A) and pEG-term-Rb-Pneu (B),** containing the hRb pocket domain fused to the LexA-DBD (white boxes), The inserted part of hRb cDNA (grey boxes labeled hRb-P 1,2 kb) encodes the amino acid residues 379-792 of the retinoblastoma protein (pocket domain). The present restriction enzyme sites are indicated, the destroyed sites are crossed out. "xxx/3xStop" marks the existence of stop codons in all three reading frames.

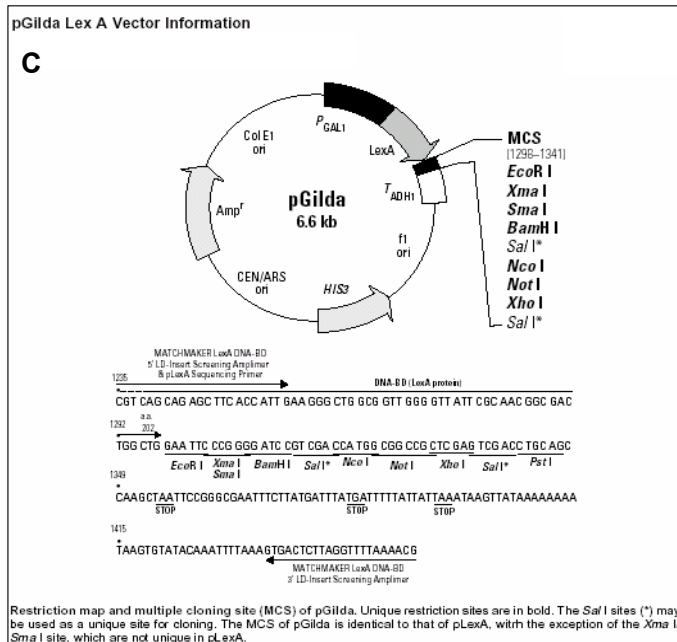
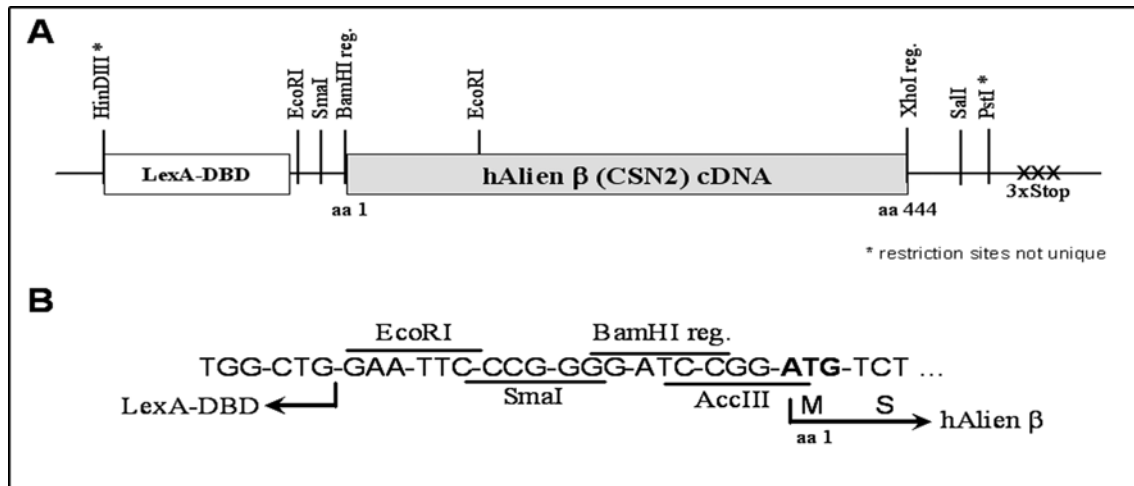


**Fig. 7. Plasmide map of the pLexA-Vector (A)** (originally published as pEG202, Gyuris et al., 1993) as provided by Clontech (www.clontech.com). This yeast expression plasmid codes for the LexA-DBD under the control of the alcohol-dehydrogenase promoter (PADH1). It further contains the ORF for bacterial ampicillin resistance (AmpR), the bacterial pBR-ori and the yeast 2μ-ori for replication in yeast as well as the yeast HIS3 gene for metabolic selection in suitable yeast strains. (B) shows the reading frames of the multiple cloning site of pLexA. The pLexA derivate vector pEG-term (Thormeyer) additionally contains Stop codons in all three reading frames.



## pGil-CSN2

pGil-CSN2 is a derivative of pGilda (Fig. 8 C, Clontech). pGil-CSN2 was constructed by excision of hAlien  $\beta$  (CSN2) cDNA by BamHI/XhoI digestion and ligation in frame to the LexA-ORF in pGilda, previously linearized using the same restriction enzymes. The resulting DNA sequence of the fusion is shown in figure 8 (A and B). This plasmid serves for expression of LexA-hAlien $\beta$  chimera protein in suitable yeast strains.

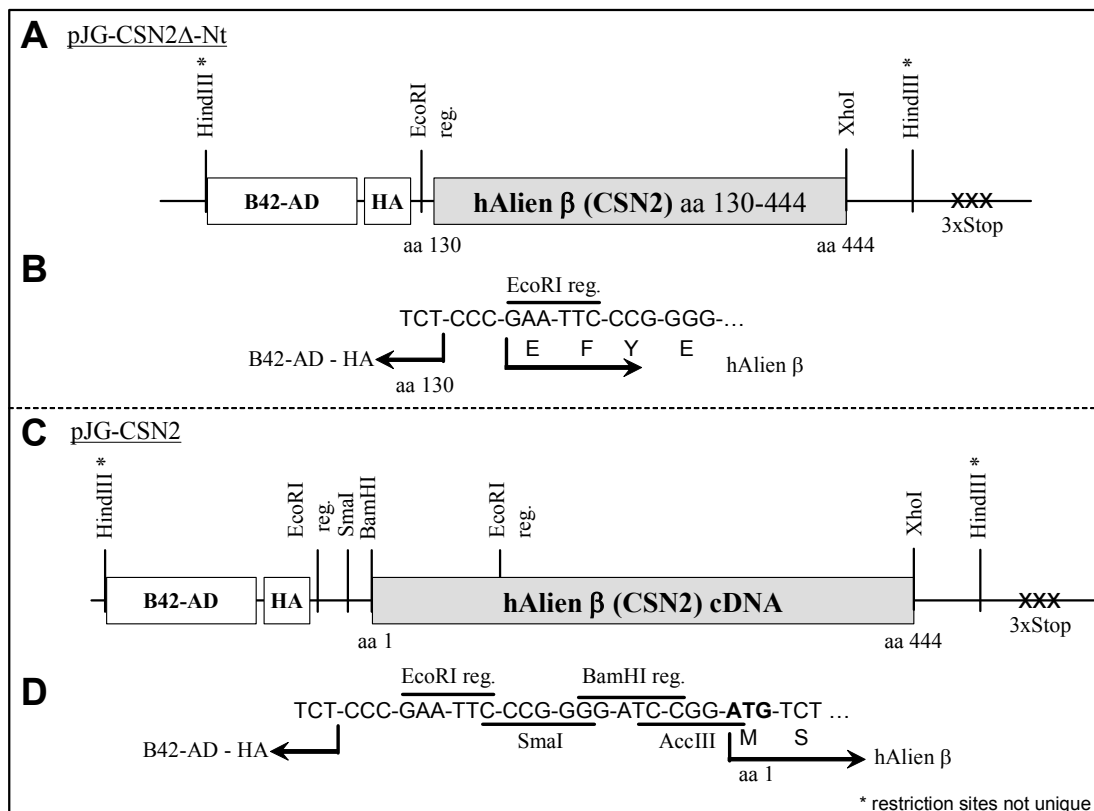


**Fig 8: (A) Schematic view of the insert of the plasmid pGIL-CSN2** (grey box), containing the hAlien $\beta$  (CSN2) cDNA fused in frame to the LexA-DBD (white box). The present restriction enzyme sites are indicated, the regenerated sites are labeled with “reg.” and sites that are not unique are marked with “\*”. “xxx-3xStop” indicates the existence of stop codons in all three reading frames. (B) Shows the DNA sequence of the fusion between the LexA-DBD and the hAlien $\beta$  (CSN2) cDNA. *In frame* codons are separated by hyphens and restriction enzyme consensus sequences are underlined and labeled. The first two amino acids (aa) are displayed using the one-letter code. Arrows indicate the ORFs of LexA-DBD and hAlien $\beta$

cDNA. (C) Vector map of pGilda as provided by Clontech ([www.clontech.com](http://www.clontech.com)). pGilda is very similar to pLexA (pEG202) with the difference that the ADHI promoter of pLexA is replaced by the glucose-dependent yeast GAL1 promoter. The lower panel shows the reading frames of the restriction sites present in the multiple cloning site (MCS) and the locations of the MATCH-MAKER sequencing primers are displayed. STOP indicates stop codons.

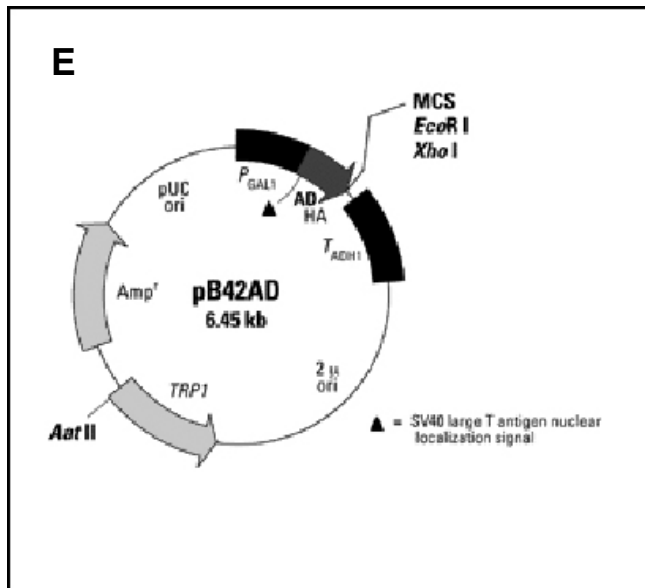
### pJG-CSN2Δ-Nt and pJG-CSN2

To construct the vectors pJG-CSN2Δ-Nt and pJG-CSN2, the plasmid pGil-CSN2 (see above) was digested with EcoRI/XhoI, obtaining two fragments. The first 1kb fragment harbored a 5' EcoRI end and a 3' XhoI end and codes for the amino acid residues 130-444 of hAlienβ (CSN2). The second fragment (~600bp) presented two EcoRI sites and encodes the first 130 N-terminal amino acids of hAlienβ. First the 1kb fragment was cloned in frame in the yeast-two-hybrid vector pJG-4-5 (pB42AD, Clontech; Fig. 9 F), previously EcoRI/XhoI digested, to obtain pJG-CSN2Δ-Nt. pJG-4-5 (pB42-AD) codes for the artificial activation domain B42, so that pJG-CSN2Δ-Nt expresses a B42-hAlienβ fusion protein when transformed in an adequate yeast strain. To generate pJG-CSN2 the plasmid pJG-CSN2Δ-Nt was opened by EcoRI digestion and the ~600bp EcoRI/EcoRI hAlien β fragment, mentioned before, was ligated. The resulting vector contains full length hAlienβ fused in frame to the B42 activation domain.

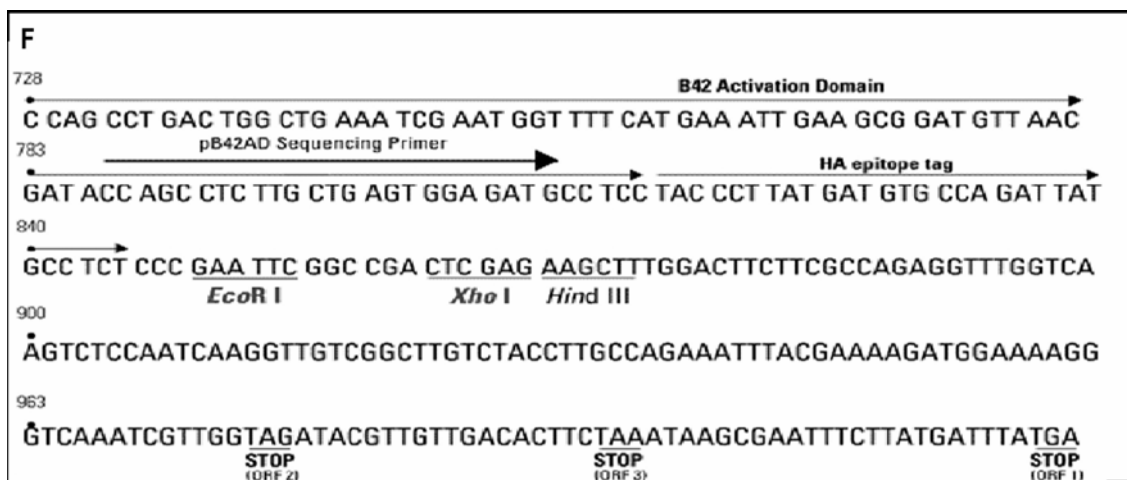


**Fig. 9 A-F: Schematic view of the inserts of pJG-CSN2Δ-Nt (A) and pJG-CSN2 (C; grey boxes) and the respective sequences of the *in-frame* fusions to the B42 activation domain (white boxes; B and D).** pJG-CSN2Δ-Nt (A) contains DNA, coding for amino acids 130-444 of hAlienβ (CSN2) and pJG-CSN2 harbors the hAlienβ full length cDNA (aa 1-444), as indicated. The restriction enzyme sites present are labeled, the regenerated sites are signed with “reg.” and sites that are not unique are marked with “\*”. “xxx/3xStop” indicates the existence of stop codons in all three reading frames. (B and D) show the DNA





pBR-ori and the yeast 2 $\mu$ -ori for replication in yeast as well as the yeast TRP1 gene for metabolic selection in suitable yeast strains. (G) This scheme shows the DNA sequence of the multiple cloning site of pB42AD. The restriction sites are underlined and coding codons are separated by spaces. Open reading frames of the B42 activation domain as well as the hemagglutinin (HA) epitope tag are marked with thin arrows over the sequence. The big arrow indicated the position of the pB42AD-sequencing primer and STOP marks stop codons.



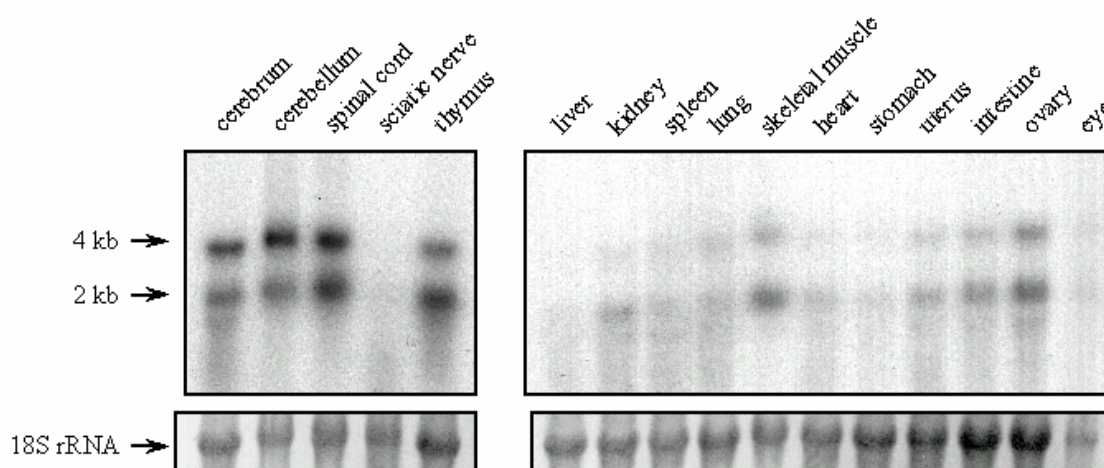
sequences of the fusions between the B42 activation domain (B42-AD) and hAlien  $\beta$  (CSN2) sequences. *In frame* codons are separated by hyphens and restriction enzyme consensus sequences are underlined. The coding amino acids (aa) are displayed using the one-letter code. Arrows indicate the open reading frames (ORF) of B42-AD and hAlien $\beta$  DNA. "HA" show the positions of *in-frame* hemagglutinin-tags (small white boxes). (E & F). Plasmid map of the pB42-AD Vector (originally published as pJG-4-5, (Gyuris et al., 1993) as provided by Clontech ([www.clontech.com](http://www.clontech.com)). This yeast expression plasmide codes for the artificial activation domain B42 under the control of the yeast GAL1 promoter (P-GAL1). It further contains the ORF for bacterial ampicilin resistance (AmpR), the bacterial

## 5.2 Studies on Alien expression

### 5.2.1 Alien mRNA expression levels vary between different rat tissues

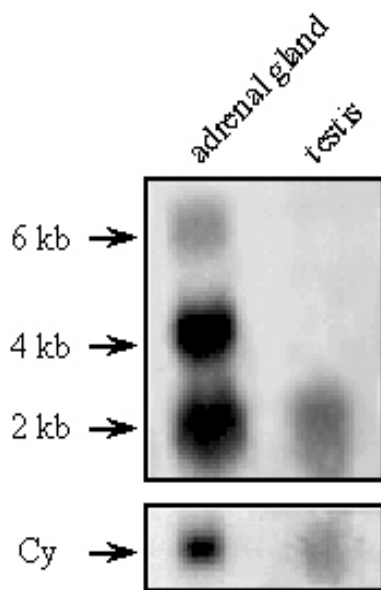
At the beginning of this work, little was known about the expression pattern of alien mRNA. Schaefer and coworkers (Schaefer *et al.*, 1999) detected two major mRNAs of ~2 kb and ~4 kb in mouse tissues.

To determine the alien mRNA expression pattern in different rat tissues, Northern blot experiments were carried out. Total mRNA from tissues of a female adult rat was hybridized using the  $^{32}\text{P}$ -labeled hAlien $\alpha$  cDNA as a probe (Fig. 10). In accordance with the data obtained by Schaefer *et al.* (1999) in mouse, two mRNAs of molecular size of ~2 kb and ~4 kb were detectable in most rat tissues. Very low levels of both mRNAs were present in liver, heart, stomach, eye, and peripheral nerve (sciatic nerve). The kidney, spleen, lung, uterus, intestine and the ovary presented moderate alien mRNA expression. Higher mRNA levels were found in skeletal muscle, uterus, and thymus. In both groups of tissues, the levels of the 2 kb messenger seem to be higher compared to the 4 kb mRNA. Noteworthy, the samples from the CNS such as cerebrum, cerebellum and the spinal cord exhibit the highest alien mRNA expression. In cerebrum and cerebellum higher amounts of 4 kb than 2 kb mRNA were detectable, whereas in the spinal cord, the ratio between both signals appears to be equal. As a loading control, the 18S rRNA stained with methylene blue was used.



**Fig. 10: Alien mRNA expression levels vary between different rat tissues.** 20 $\mu\text{g}$  of total RNA from the indicated rat tissues were applied in this Northern blot experiment. The  $^{32}\text{P}$ -labeled full-length alien $\alpha$  cDNA (BamHI/BglII) fragment from pAB-hAlien $\alpha$  (Dressel *et al.*, 1999) was used as a probe. The upper panel shows the radiography of alien specific hybridization signal after two weeks exposure. Signals of the two major alien messengers are indicated by arrows marked with 2 kb and 4 kb. As a loading control the methylene blue-stained 18S rRNA is shown (lower panel).

Additionally, a Northern blot experiment comparing alien mRNA expression in adrenal gland and testis, extracted from tissues of various male adult rats was performed. Similarly, to data achieved by Schaefer and coworkers (Schaefer *et al.*, 1999), in testis, the major mRNA signal is detected at the size of 2 kb, whereas the 4 kb mRNA is strongly reduced or even absent. Hybridization with cyclophilin cDNA probe served as a loading control. Surprisingly, in addition to the already known mRNAs of 2 kb and 4 kb, a novel mRNA of about 6 kb is detectable in the adrenal gland (Fig. 11).

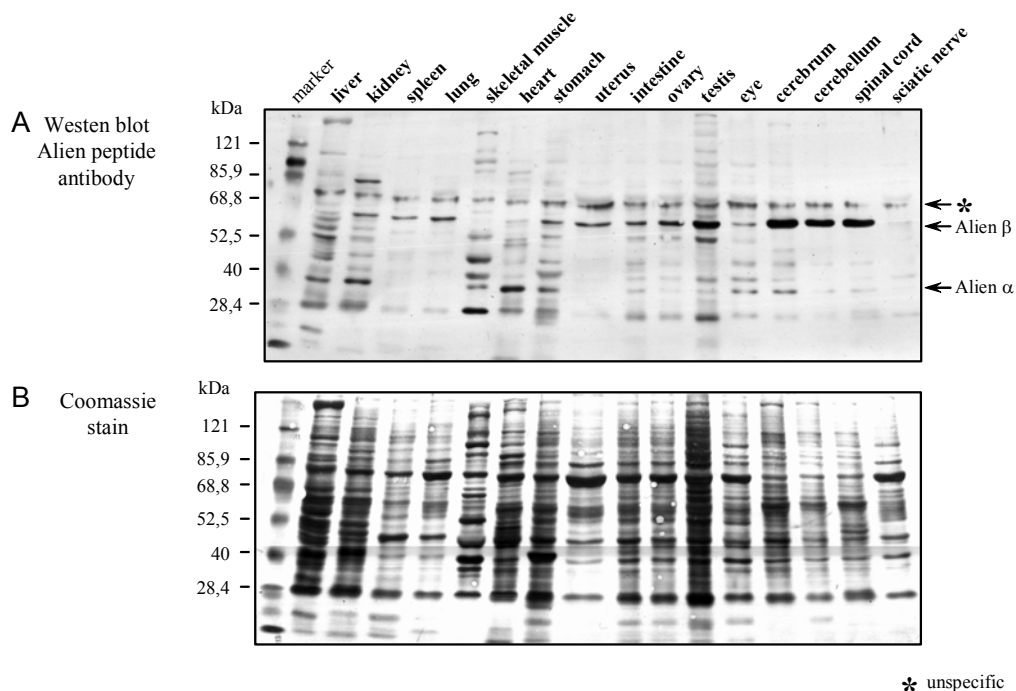


**Fig. 11: An additional 6 kb alien mRNA is detectable in rat adrenal gland.** 60 $\mu$ g of total RNA from rat testis and from adrenal glands of 16 adult rats were used in this Northern blot experiment hybridized with the radioactive alien $\alpha$  cDNA. The size of the obtained signals in the different rat tissues are indicated in kb and marked with arrows. Hybridization of the blot with cyclophilin probe (Cy) was used as a loading control (lower panel).

### 5.2.2 Multiple proteins are detectable with the Alien antibody in different rat tissues

To investigate the Alien protein expression in different rat tissues and organs, Western blot experiments, using an Alien specific peptide antibody (Pep AK-1; Dressel *et al.*, 1999) were performed. Total protein extracts from 24 different tissues from female and male adult rats were applied in the Western blot experiments (Fig. 12 A, Fig. 13 A). Surprisingly, multiple different bands were detected next to the expected signals of Alien $\alpha$  (~40 kDa) and Alien $\beta$  (~54 kDa). The majority of the unexpected signals coincide with abundant protein bands, visualized on the Coomassie-stained PVDF-membrane (Fig. 12 B, Fig 13 B). Therefore, some of these signals may be likely to be unspecific. Referring to the expected signals of the known Alien $\alpha$  and Alien $\beta$  isoforms, the following observations are made. The samples derived from sciatic nerve (Fig. 12 A) and from thyroid gland (Fig. 13 A) harbor extremely low levels of both Alien $\alpha$  and

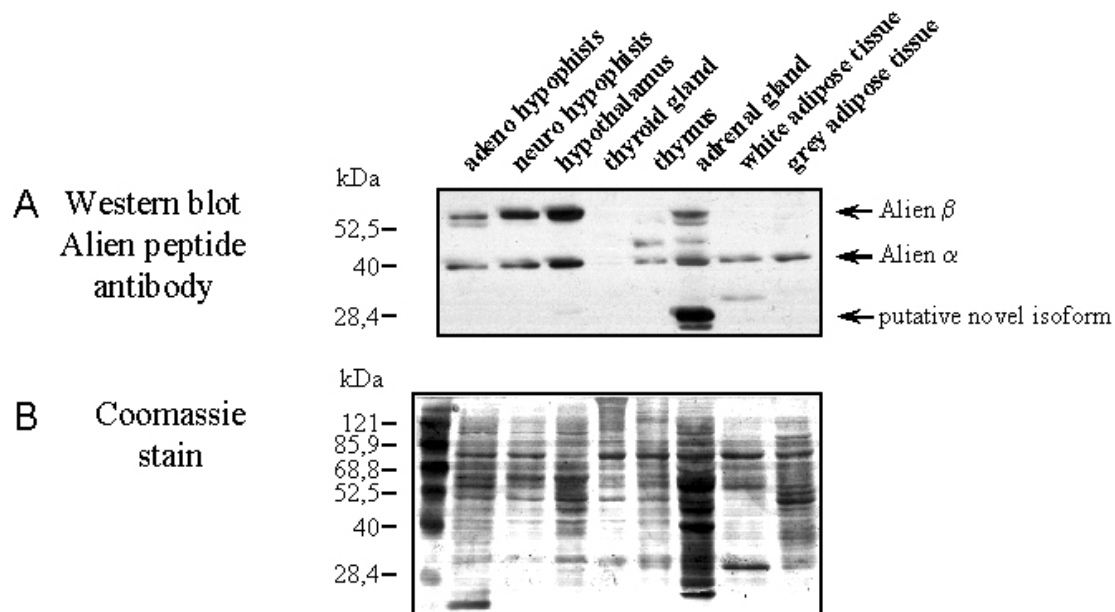
Alien $\beta$  proteins. Low or apparently absent Alien $\beta$  protein expression could be observed in liver, skeletal muscle, heart (Fig. 12 A), and in thymus and white as well as grey adipose tissue (Fig. 13 A). In contrast to this, little or perhaps no Alien $\alpha$  expression is seen in spleen, lung, uterus, ovary, testis, cerebellum and the spinal cord (Fig. 12 A). Noteworthy, and in contrast to the peripheral nervous system (sciatic nerve), the tissues from the CNS, such as cerebrum, cerebellum, spinal cord, adeno- and neuro-hypophysis as well as the hypothalamus, present the highest Alien $\beta$  expression (Fig. 12 A, 13 A). This is in line with the high alien mRNA levels detected in CNS tissues by Northern blotting.



**Fig 12: Multiple proteins are detectable with the Alien antibody in different rat tissues.** (A) 30 mg of total protein of the indicated rat tissues were applied in this Western blot experiment. The anti-Alien peptide antibody (Pep-AK1; Dressel *et al.*, 1999) was used to detect Alien proteins. The sizes of the molecular marker are indicated in kDa. Arrows labeled with Alien $\alpha$  and Alien $\beta$  indicate the position of the known alien isoforms. \* Unspecific bands. (B) After performing the Western blot, the same PVDF membrane was stained with Coomassie blue to serve as a loading control.

Remarkably, the most prominent signal detected by the Alien antibody in the adrenal gland, is situated at a molecular size of ~28 kDa. Although this band coincides with high total protein amount on the PVDF membrane, other areas of this lane are not recognized by the anti-Alien antibody. Thus, the detected band is likely to be specific.

Taken together, the 28 kDa signal may represent a putative novel Alien isoform specific for adrenal gland.



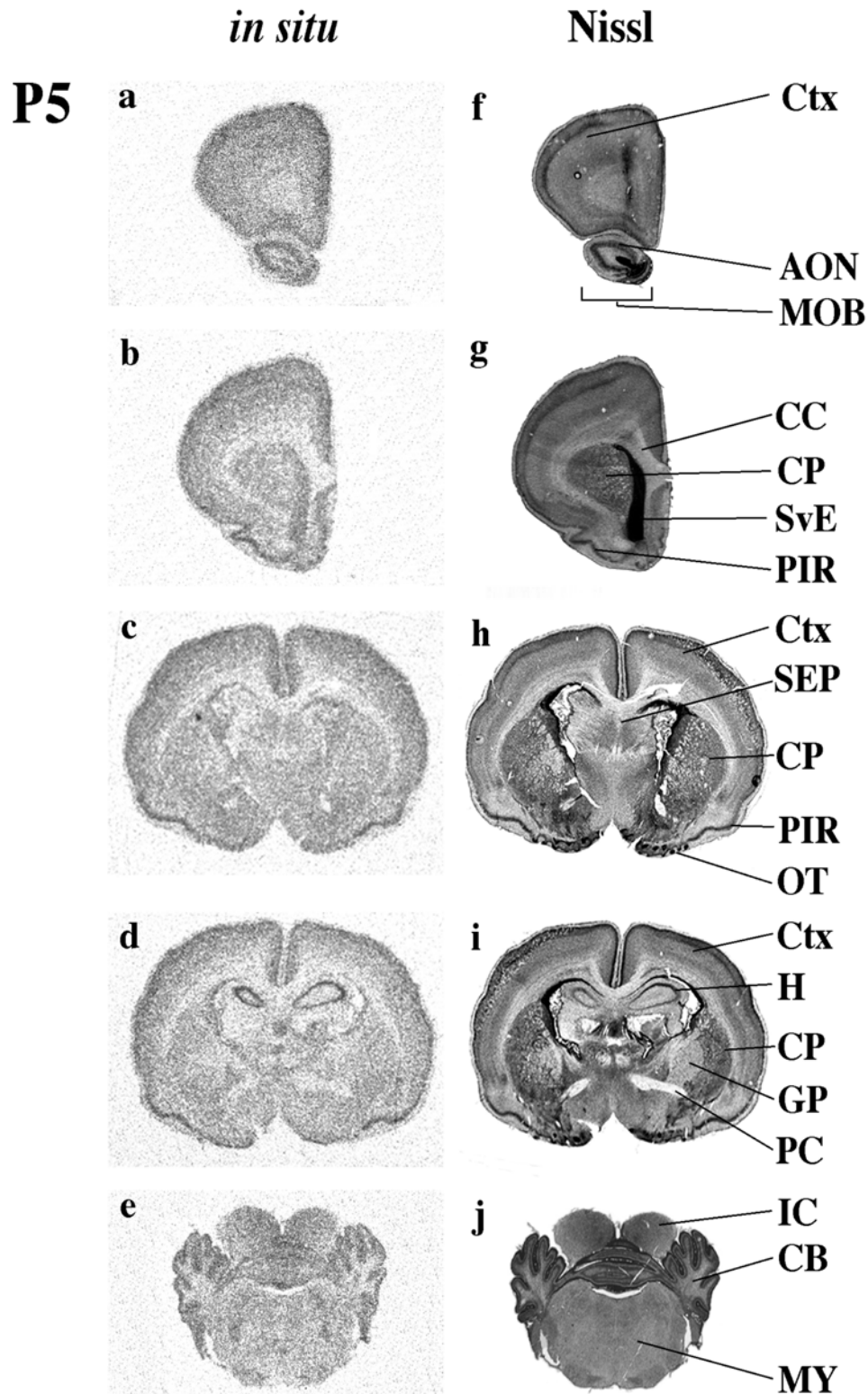
**Fig. 13: Multiple proteins are detectable with the Alien antibody in different rat tissues – a putative novel Alien isoform is present in adrenal gland.** 30mg of total protein of the indicated rat tissues were applied in this Western blot experiment. The anti-Alien peptide antibody (Pep-AK1; Dressel *et al.*, 1999) was used to detect Alien proteins. The sizes of the molecular marker are indicated in kDa. Arrows labeled with Alien $\alpha$  and Alien $\beta$  indicate the position of the known alien isoforms. Another arrow shows the size of a putative novel Alien isoform. (B) After performing the Western blot, the same PVDF membrane was stained with Coomassie blue to serve as a loading control.

Resuming these findings, Alien protein isoforms are present throughout different rat tissues, although differences in distribution could be observed. In some tissues both Alien $\alpha$  and Alien $\beta$  are expressed equally, whereas others harbor either one or the other of the two Alien isoforms. Thus, in spite of widespread expression of Alien mRNA species, diversity in distribution of Alien protein isoforms is observable in different rat tissues

### 5.2.3 Alien mRNAs are ubiquitously present in the rat brain and their expression pattern is suggestive to be predominantly neuronal

Because of the high alien mRNA and protein expression levels in rat brain preparations, further investigations focused on the rat central nervous system (CNS).

To determine the pattern of alien mRNA expression in the rat brain, radioactive *in situ* hybridization analysis using a specific antisense alien riboprobe (pT7-asAlien<sub>419</sub>-SP6 vector; Fig. 1) was performed. It should be pointed out, that this riboprobe should



**Fig. 14: Alien mRNAs are ubiquitously present in the rat brain predominant neuronal expression.** *In situ* hybridization with radioactive alien antisense riboprobe on rat brain sections of animals at postnatal day 5. Brain areas are indicated: Subventricular epithelium (SvE), cerebral cortex (CTX), piriform cortex (PIR) layer II, anterior olfactory nucleus (AON), and olfactory tubercle (OT), caudate putamen (CP), globus pallidus (GP), pyramidal and granular layers of the hippocampus (H), neuronal layers of the developing cerebellum (CB), corpus callosum (CC), septum (SEP), anterior commissure

(AC), main olfactory bulb (MOB), inferior colliculus (IC), medulla (MY). The brain sections are displayed in order from rostral to caudal. Nissl staining of the same coronal brain sections is shown to visualize brain specific areas. The control for specificity of the alien riboprobe is included in Figure 16 (C, sense).

hybridize with both alien mRNAs, so that one could not distinguish between the different alien mRNAs in these experiments.

In 5 day old animals (P5) alien mRNA is expressed throughout the brain with higher levels in the subventricular epithelium (SvE), the cerebral cortex (CTX), piriform cortex (PIR) layer II, anterior olfactory nucleus (AON) and olfactory tubercle (OT), as well as in the caudate putamen (CP), globus pallidus (GP) and pyramidal and granular layers of the hippocampus (H; Fig. 14, panel a to j). Neuronal layers of the developing cerebellum (CB) also showed high hybridization signal. Lower expression was observed in other brain areas such as corpus callosum (CC), septum (SEP), the anterior commissure (AC) and cerebellar white matter at P5 (Fig. 14). All the above-mentioned brain regions with higher alien mRNA expression are composed mainly of neurons, whereas those rich in fibers and glial cell populations show low alien expression. At postnatal day 15 (P15) the overall expression of alien mRNA persists and roughly the same pattern was found (Fig. 16 B, and data not shown).

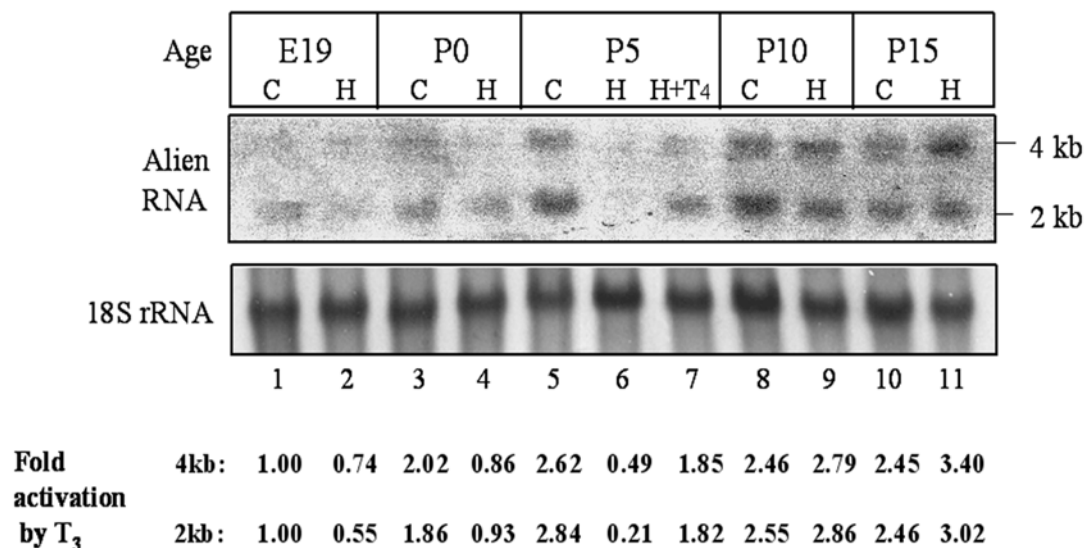
Thus, alien RNA exhibits a ubiquitous, predominant neuronal expression pattern in rat brain.

#### **5.2.4 Alien mRNA expression is regulated by T3 during rat brain development**

One known function of Alien $\alpha$  is to act as a corepressor for the thyroid hormone receptor mediating transcriptional repression of target genes in absence of thyroid hormone (Dressel *et al.*, 1999). Since thyroid hormones are essential for brain maturation and the lack of T3 in hypothyroidism leads to severe alteration of expression of thyroid hormone regulated genes, it was investigated whether alien expression is also altered in the hypothyroid rat brain.

For this purpose, Northern blot analyses of rat brain tissue from normal and hypothyroid rats of different ages were carried out. Similarly to other tissues (Fig. 10, Fig. 11), two transcripts of 2 kb and 4 kb were detected at all ages studied from embryonic day 19 (E19) to postnatal day 15 (P15). In euthyroid (control, C) rats, both RNAs were

maximally expressed at P10, and the 2 kb messenger was always predominant (Fig. 15). From E19 to P5, the levels of both alien mRNAs were lower in hypothyroid animals. The differences, however, disappeared in later ages reaching a plateau with spontaneous normalization in expression levels even without any hormone treatment of hypothyroid animals. In fact, at P10 to P15 the expression of alien mRNA expression was even higher in hypothyroid animals. Additionally, at later ages hypothyroidism reverted the ratio between alien transcripts and the 4 kb mRNA was predominant over the 2 kb mRNA. Remarkably, hormone administration to hypothyroid rats caused partial normalization of the level of both alien mRNAs at P5 (H+T4). This finding indicates that thyroid hormone regulates alien mRNA expression in rat brain.



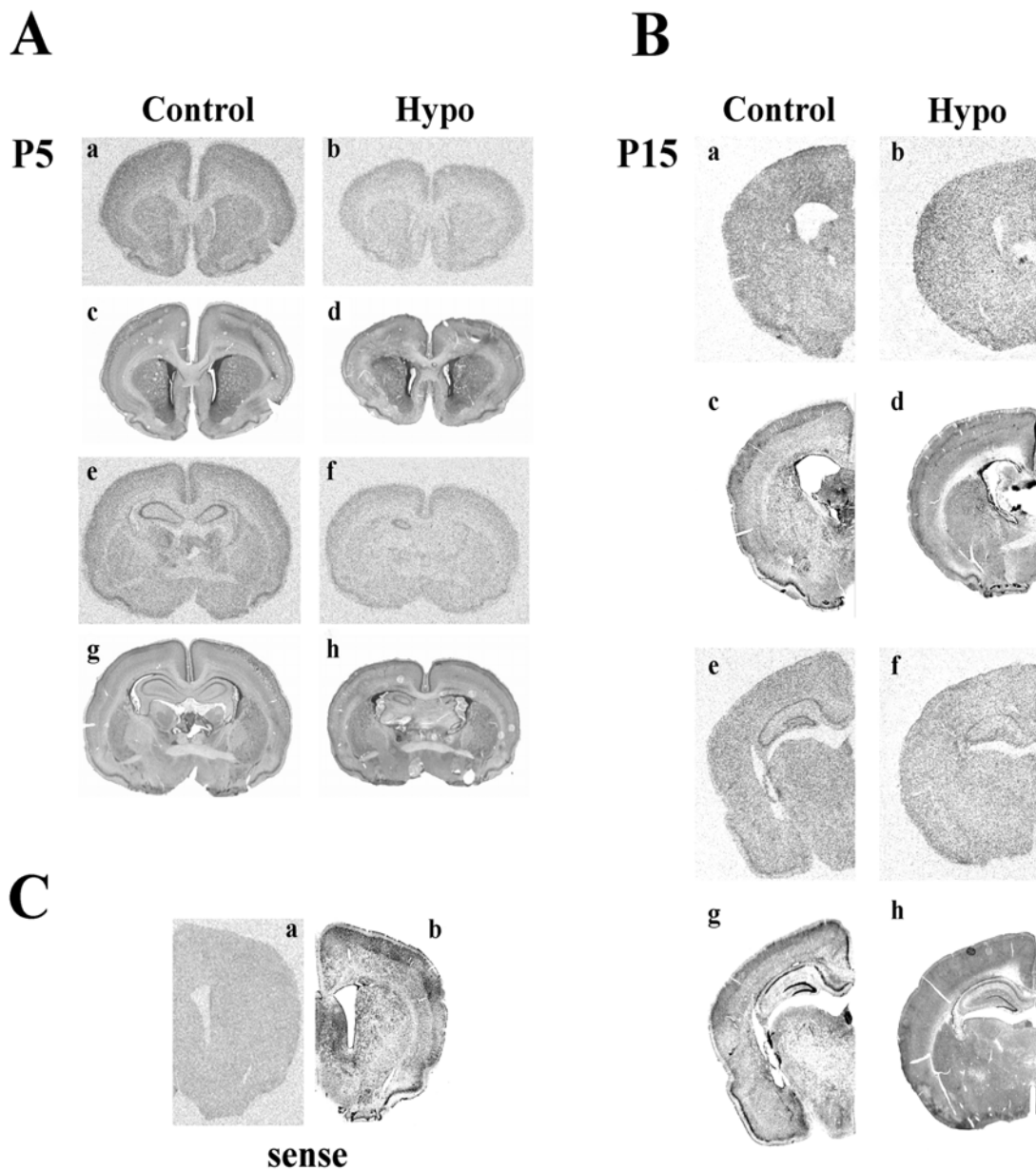
**Fig. 15: Alien mRNAs are regulated by thyroid hormone during rat brain development.** This Northern experiment was performed with poly-A<sup>+</sup>-mRNA isolated from rat brain at the indicated ages from embryonic day 19 (E19) up to postnatal day 15 (P15). Two alien specific bands were detected at 2 kb and 4 kb. Normal, control rats (C) are compared with hypothyroid (H) rats. At P5 thyroxine (T4) treatment of rats was performed as indicated in material and methods (H+T4). Methylene-blue stained 18S rRNA is shown as a loading control (lower panel). Lanes are numbered from 1 to 11 and the relative fold induction of control to hypothyroid is annotated.

### 5.2.5 Alien mRNA is generally down regulated in the hypothyroid rat brain at postnatal day 5 – Expression levels are normalized at postnatal day 15

Because at P5 there was an apparent down regulation, as assessed by Northern blotting, whereas at P15 only slight differences were detected between control and hypothyroid



animals, brain samples from 5 and 15 day old control and hypothyroid rats were chosen for investigation by *in situ* hybridization (Fig. 16).



**Fig. 16: Hypothyroid animals exhibit lower Alien gene expression *in vivo*.** Normal, control (Control) and hypothyroid (Hypo) rat brain was used for *in situ* hybridization with alien antisense riboprobe for both brain sections at postnatal day 5 (A, P5) and P15 (B). Nissl staining of the same brain samples is shown to visualize brain specific areas. As control for specific *in situ* hybridization signal the Alien sense riboprobe was used (C).

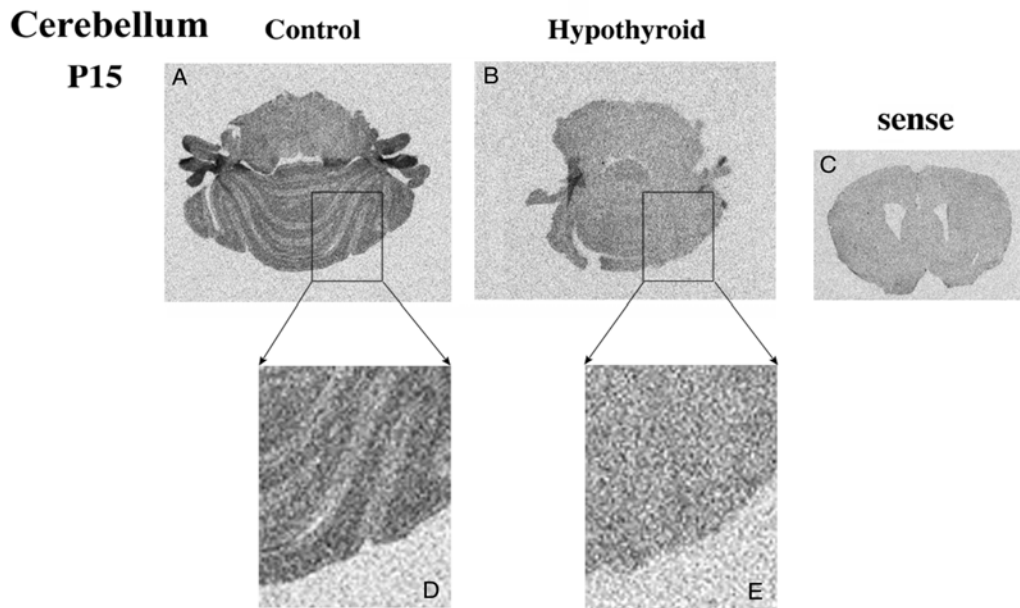
In agreement with the Northern data a general down regulation of alien mRNAs was found in hypothyroid rats at P5 (Fig. 16 A, panels a, b and e, f). At P15 the regional

pattern and level of mRNA expression is roughly maintained (Fig. 16 B, panels a & e). Comparison of these samples with P15 hypothyroid brains (Fig. 16 B, panels b & f) reveal only slight differences in alien mRNA levels. These observations are in agreement with the data obtained in Northern blot analysis at postnatal day 5 and 15 (Fig. 15, lanes: 6, 7, 10, 11). These results indicate that alien expression is under thyroid hormone regulation in the rat brain during the postnatal period *in vivo*.

### **5.2.6 Alien mRNA expression is severely reduced in the hypothyroid rat cerebellum**

Since thyroid hormone is also essential for maturation of the cerebellum and since neuronal layers of the developing cerebellum (CB; Fig. 14, panel e) showed high alien hybridization signal, it was of interest to investigate whether alien is regulated by T3 in the cerebellum, too.

Cerebellar development is delayed respective to the cerebrum. The developmental state of the rat cerebrum at postnatal day 15 approximately corresponds to that of the cerebrum at P5 (Nicholson and Altman, 1972; Altman and Bayer, 1997). Therefore, also slices of rat cerebellum at P15 were hybridized with the radioactively labeled antisense alien riboprobe. Strong alien mRNA expression in the cerebellar neuronal layers of the euthyroid rat cerebellum was detected (Fig. 17 A and 17 D). Clearly, differentiation between internal granule and external germinal cell layers is possible. On deprivation of thyroid hormone in animals, alien hybridization signal completely disappeared (Fig. 17 B, 17 E). This may in part be due to the dependence of cerebellar morphogenesis, such as granule cell migration on thyroid hormone action. These processes are triggered by thyroid hormone and lead to the physiological formation of the internal and external granule cell layers of the cerebellum under euthyroid conditions (Rakic, 1972; Hatten and Heintz, 1995; Altman and Bayer, 1997). Consequently, one could state that the failure of formation of cerebellar layers during hypothyroidism could disperse the hybridization signal of alien expressing cells. This would lower the detected signal. However, comparison of the signal obtained in hypothyroid animals (Fig. 17 B, 17 E) with background hybridization level (Fig. 17 C; hybridization with sense alien riboprobe), show that lack of thyroid hormone completely abolishes alien mRNA expression in cerebellum at postnatal day 15.

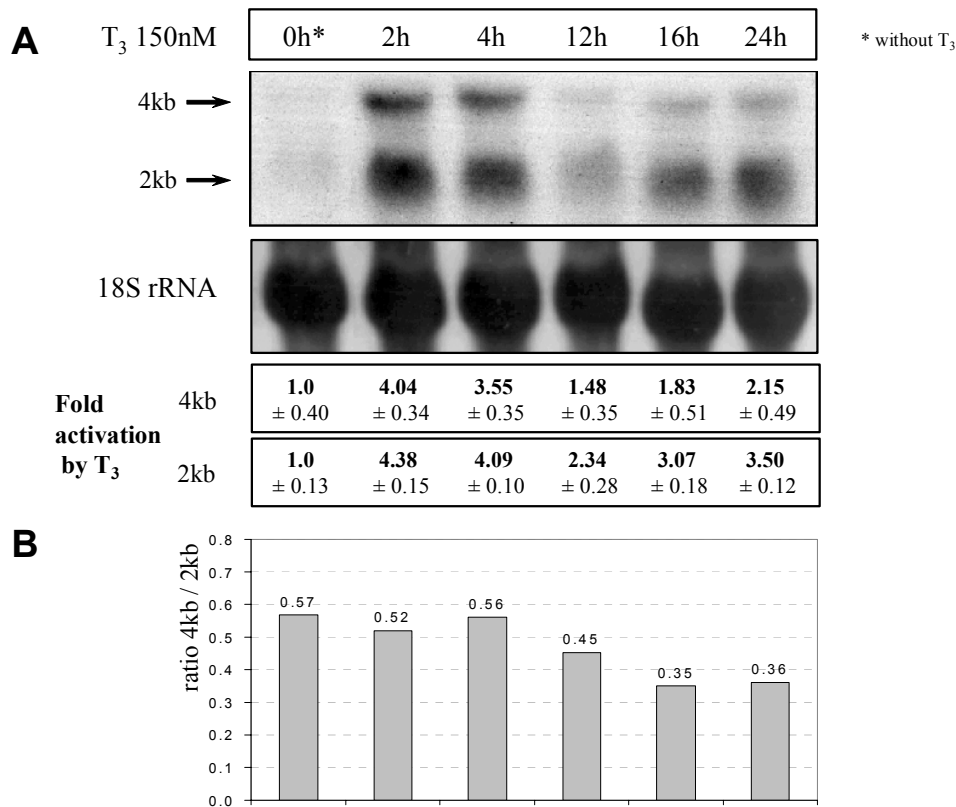


**Fig. 17: Alien mRNA expression is severely reduced in the hypothyroid cerebellum at postnatal day 15.** Normal, control (Control, A, D) and hypothyroid (Hypothyroid, B, E) sections of rat cerebellum at postnatal day 15 (P15) were used for *in situ* hybridization with alien antisense riboprobe. Magnifications of the marked sections are shown to visualize cerebellar layers. As control for specific *in situ* hybridization, the Alien sense riboprobe was used (C).

### 5.2.7 Alien mRNAs are induced by T3 treatment in TR expressing N2A neuroblastoma cells

Since Northern blot and *in situ* hybridization analyses showed T3-dependence of alien mRNA expression in the rat brain *in vivo*, it is interesting to investigate whether such a hormone response exists in cultured cell lines. For that, N2A neuroblastoma cell clones stably expressing TR $\alpha$  and TR $\beta$ , respectively, were chosen (Lebel *et al.*, 1994). Thyroid hormone mediated induction of alien messages after different periods of T3 treatment in those cell lines (Figs. 18 & 19). N2A-TR $\alpha$  and TR $\beta$  cells were treated with T3 for the indicated periods before cell harvest, RNA isolation and test for endogenous alien expression in Northern experiments (Figs. 18, 19).

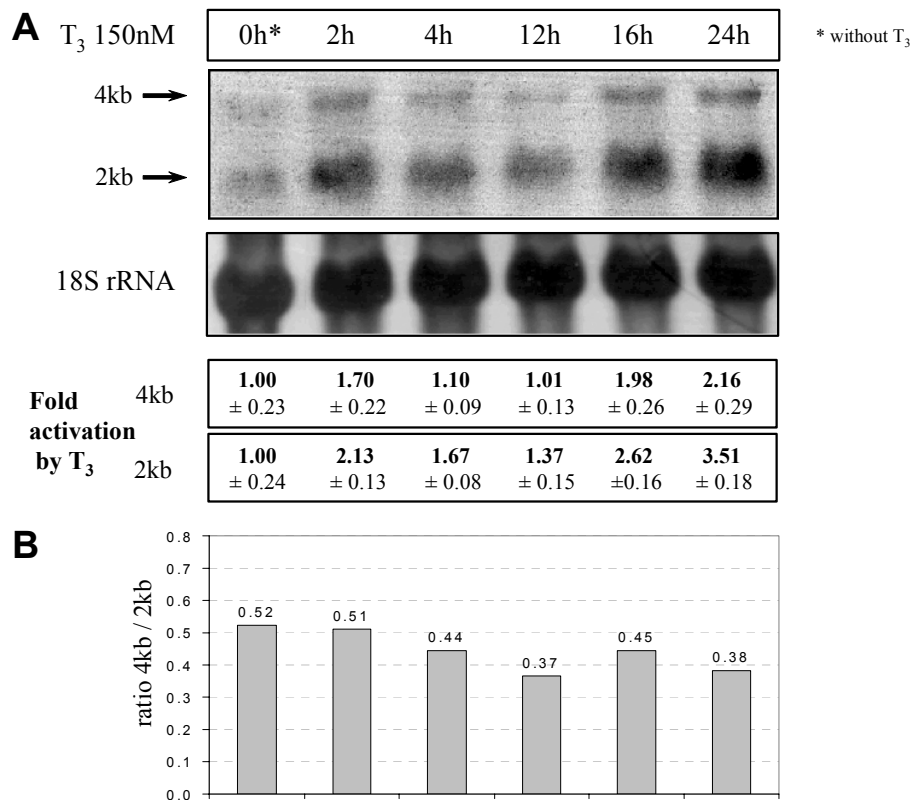
Both cell clones expressing either TR $\beta$  (Fig. 18) or TR $\alpha$  (Fig. 19) show rapid induction of both Alien 2 kb and 4 kb messages within 2 hours. The TR $\beta$  cells exhibit a stronger induction compared to the TR $\alpha$  expressing N2A cells. As control, parental N2A cells lacking significant amounts of functional thyroid hormone receptors (Lebel *et al.*, 1994) exhibit no substantial induction of the two alien transcripts after 2 and 4 hours of thyroid hormone treatment (Fig. 20 A).



**Fig. 18: Alien mRNA is induced by thyroid hormone in N2A-TR $\beta$  cells.** (A) Neuroblastoma cells (N2A-cell line) stably expressing TR $\beta$  were treated for the indicated times with thyroid hormone (T<sub>3</sub>) at a final concentration of 150 nM prior harvest and analyses of Alien gene expression by Northern blotting. Total RNA was hybridized with the alien cDNA probe. Two alien specific messages at 2 kb and 4 kb are inducible by treatment with T<sub>3</sub>. The lower panel shows the methylene-blue-stained 18S rRNA as loading control. (B) The ratio (4 kb RNA : 2 kb RNA) of the alien specific messages is compared to each other at the different time points. The fold induction referring to "without hormone" is annotated.

The obtained signals from this Northern experiment were set to the cyclophilin control hybridization (Fig. 20 B), supporting the observation of a TR-dependent induction of alien gene expression. Interestingly, the alien mRNA expression is reduced after 12 hours of T<sub>3</sub> treatment in both TR expressing N2A cell lines before the expression is increased slightly at the 24-hour time point (Figs. 18, 19).

Quantification by densitometry of amounts of alien mRNA species in the Northern blots of RNA of both N2A-TR $\alpha$  and TR $\beta$  cells revealed a ratio of approx. 1:2 (4 kb / 2 kb = ~0.5; Figs. 18 B, 19 B) in favor of the 2 kb mRNA at 2 h and 4 h T<sub>3</sub> treatment. Up to 24 h of hormone stimulation a slight increase of the 2 kb messenger can be observed and a ratio of ~1:3 in favor for the 2 kb mRNA was calculated (4 kb / 2 kb = ~0.3). Thus, these data suggest that alien gene expression is rapidly induced by thyroid hormone treatment depending on each of the two thyroid hormone receptor isoforms.

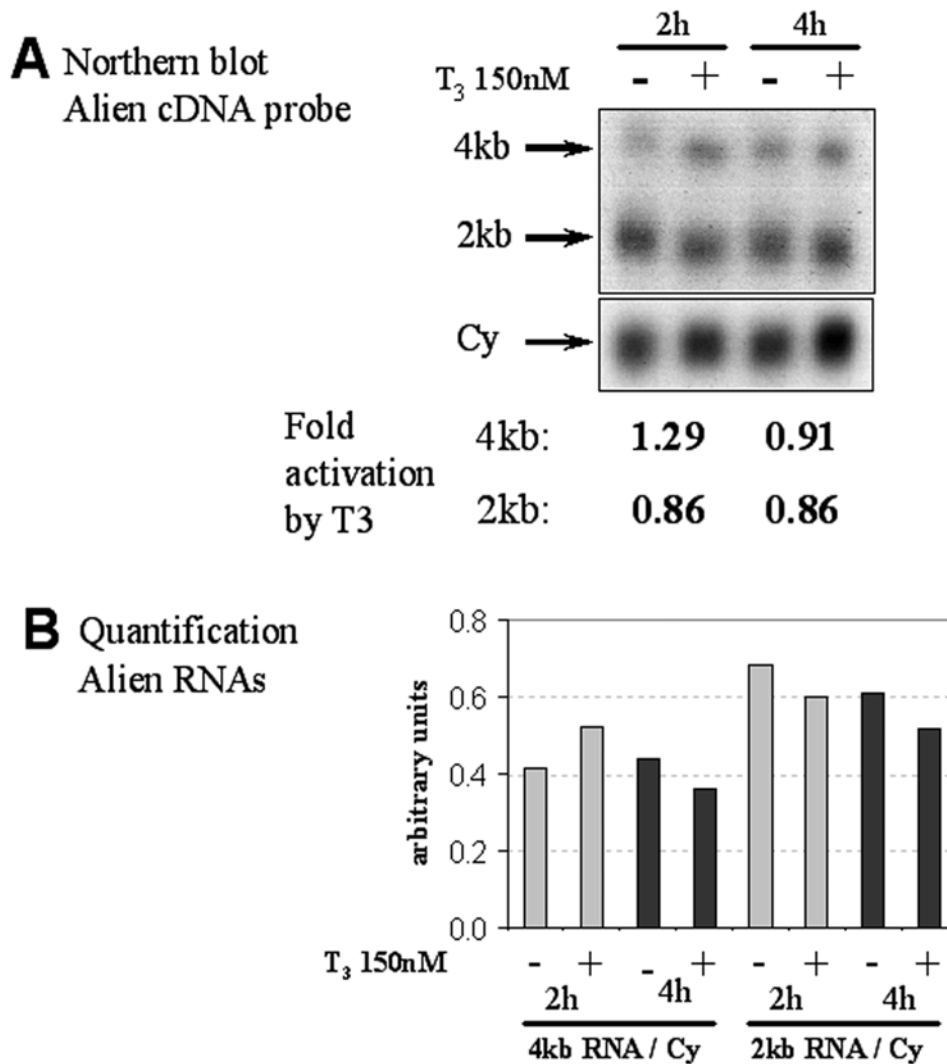


**Fig. 19: Alien mRNA is induced by thyroid hormone in N2A-TR $\alpha$  cells.** Neuroblastoma cells (N2A-cell line) stably expressing TR $\alpha$  were treated for the indicated times with thyroid hormone (T<sub>3</sub>) at a final concentration of 150 nM prior harvest and analyses of Alien gene expression by Northern blotting, hybridizing with the alien cDNA probe. Two alien specific messages at 2 kb and 4 kb are inducible by treatment with T<sub>3</sub> in the TR expressing but not in the parental N2A cells. The lower panel shows the methylene-blue stained 18S rRNA as loading control. (B) Shows the ratio (4 kb RNA : 2 kb RNA) of the alien specific messages compared to each other at the different time points. The fold induction referring to "without hormone" is annotated.

### 5.2.8 Alien mRNAs are induced in confluent N2A-TR $\alpha$ and N2A-TR $\beta$ cells in hormone free conditions

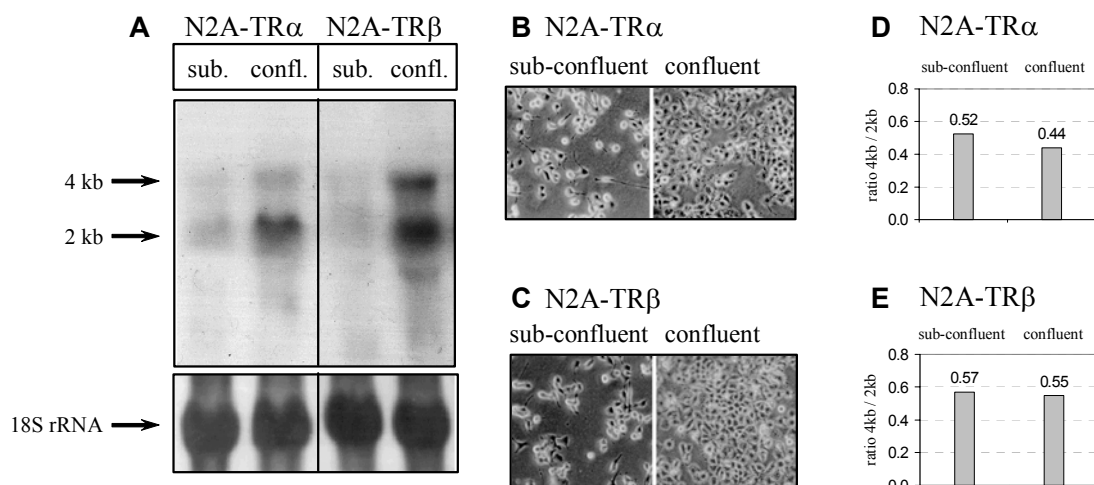
As already mentioned, the alien messages are rapidly induced after 2 h T<sub>3</sub> treatment, followed by descending mRNA levels up to 12 h hormone exposure. At the 16 h and 24 h time points, a second increase of alien mRNA is observable. Thus, the time course of T<sub>3</sub> mediated alien induction seems to be biphasic in both N2A-TR $\alpha$  and TR $\beta$  (Figs. 18, 19). This raises the question, whether regulation of alien expression may follow two different, perhaps independent mechanisms. The only major difference between the used cultured cells of the two experimental series in N2A-TR $\alpha$  and N2A-TR $\beta$  cells lies in the increasing confluence of the cell cultures during hormone treatment. To investigate whether the reason for the second raise of alien messages depends on the

confluence of the cultured cells, N2A-TR $\alpha$  and N2A-TR $\beta$  cells were grown in hormone free medium. The cells were harvested either in sub-confluent or confluent stages (Fig. 21 B & C) and total RNA obtained was analyzed for endogenous alien expression by Northern blot. Both expected alien mRNA signals of 2 kb and 4 kb are expressed more strongly in confluent than in sub-confluent growing cells in absence of T3 (Fig. 21 A).



**Fig. 20: Alien mRNA is not induced by thyroid hormone in parental N2A cells lacking significant amounts of TRs.** Neuroblastoma cells (N2A-parental cell line) were treated for the indicated times with thyroid hormone (T3) at a final concentration of 150 nM prior to harvest and analyses of Alien gene expression by Northern blotting. Total RNA of parental N2A cells was isolated and hybridized with the alien cDNA probe. Two alien specific messages at 2 kb and 4 kb are detected in all samples. Treatment with T3 did not alter significantly the amount of alien RNAs in the parental N2A cells. The lower panel shows the RNA signal upon hybridization with radioactive cyclophilin probe as loading control. (B) Represents the quantification of the alien specific messages compared to that of cyclophilin RNA content. The fold activation by T3 is annotated.

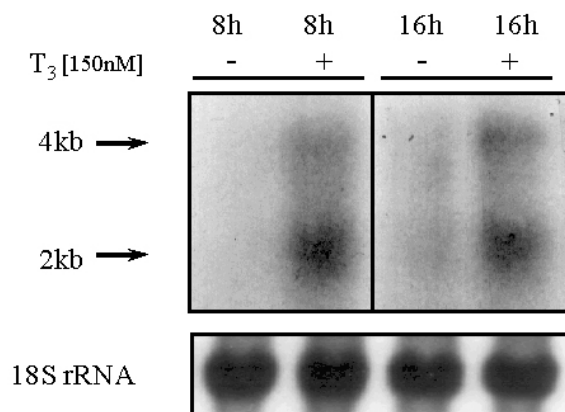
Addressing the ratio of the two alien mRNAs, the amount of the 2 kb signal was twice as strong as the 4 kb in both N2A-TR $\alpha$  and N2A-TR $\beta$  cells in sub-confluent conditions. The confluent N2A-TR $\beta$  cells maintained this ratio, whereas the N2A-TR $\alpha$  cells showed a little more of the 2 kb than of the 4 kb message (Fig. 21 D, E). Thus, the ratio of the amount of alien mRNAs during induction by cell confluence does not differ significantly from those observed during T3 dependent up regulation. These results suggest a second novel mechanism of regulation of alien mRNAs, perhaps involved in or caused by processes of cell-cell contact or contact inhibition.



**Fig. 21: Alien mRNAs are induced in confluent N2A-cells stably expressing TRs in hormone-depleted medium, suggesting a possible role in cell-cell contact mechanisms.** (A) Neuroblastoma cells (N2A-cell line) stably expressing TR $\alpha$  or TR $\beta$  and were grown in hormone depleted medium up to either sub- or confluent cell density (B & C; photography of the used cell cultures). Cells were harvested using trypsin and total RNA was extracted from equal number of cells. RNA was analyzed for alien gene expression by Northern blotting, hybridizing with the alien cDNA probe. Two alien specific messages at 2 kb and 4 kb are induced in confluent but not in sub-confluent growing cells in both TR expressing N2A cell lines in absence of hormone. The lower panel shows the methylene-blue stained 18S rRNA as loading control. (D & E) Represents the ratio (4 kb mRNA : 2 kb mRNA) of the alien specific messages compared to each other at the different cell densities.

### 5.2.9 Alien mRNAs are expressed and regulated by T3 in glial cells

*In situ* analyses displayed a preferentially neuronal alien expression pattern in the rat brain (Fig. 14, 16), although basal expression of alien in glial cell populations cannot be ruled out. Additionally, these *in situ* analyses comparing euthyroid and hypothyroid brains revealed a general down regulation of alien mRNA signal. This would include both neuronal- and glial cell-containing brain areas. Therefore, alien expression and also possible regulation by thyroid hormone in glial cells is of interest. As a cell line model, a mouse glial precursor cell line B3.1-TR $\alpha$  was chosen. Since the parental B3.1 cells lack significant levels of thyroid hormone receptors (Iglesias *et al.*, 1994), the derivate B3.1-TR $\alpha$  cells were used. This cell line was generated in our laboratory and express stably TR $\alpha$  (Iglesias *et al.*, 1994). B3.1-TR $\alpha$  cells were grown in hormone depleted medium and treated or not with 150 nM T3 for eight and sixteen hours prior harvesting and extraction of total RNA. A Northern blot performed with these RNAs was hybridized with the radioactive alien cDNA probe (Fig. 22). Induction of both alien transcripts upon T3 administration was observed at both time points compared to untreated cells. Thus, alien is expressed and regulated by thyroid hormone in glial cells as well.



**Fig. 22: Alien mRNAs are expressed and regulated by T3 in B3.1-TR $\alpha$  astrocyte cells.** Glial cells (B 3.1-cell line) stably expressing TR $\alpha$  were treated or not for the indicated times with thyroid hormone (T3) at a final concentration of 150 nM prior harvest and analyses of Alien gene expression by Northern blotting hybridizing with the alien cDNA probe. Two alien specific messages at 2 kb and 4 kb are inducible by treatment with T3 at both time points. The lower panel shows the methylene-blue stained 18S rRNA as loading control.

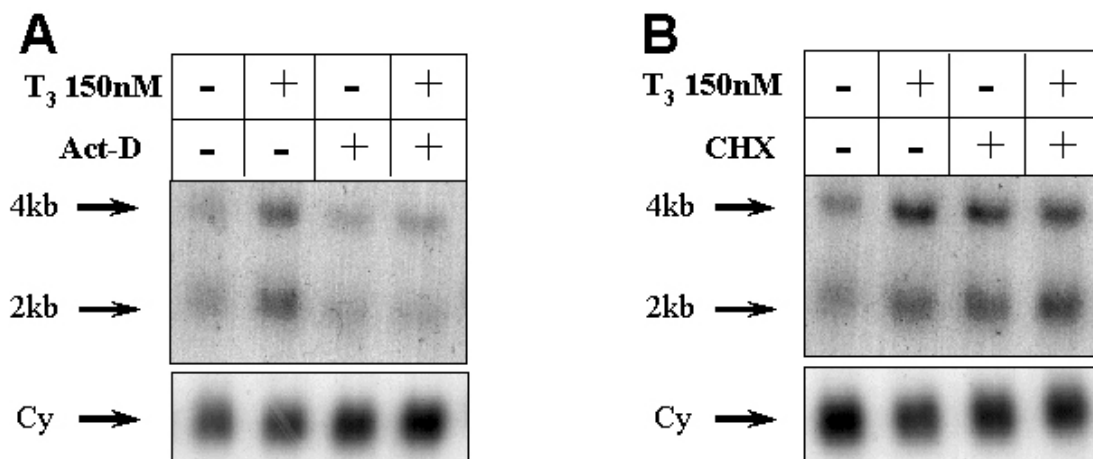
### 5.2.10 Both, actinomycin-D and cycloheximide prevent T3-mediated Alien gene expression in N2A-TR $\beta$ cells

To gain insight into the mechanism of T3 regulation, it was of interest to analyze whether *de novo* protein synthesis is required for T3 induction of alien transcripts. For this purpose, treatment of N2A-TR $\beta$  cells with thyroid hormone was performed in N2A-



TR $\beta$  cells in the presence and absence of 10 mg/ml cycloheximide, a general inhibitor of translation. As a control, induction of alien messengers by T3 was efficiently prevented by actinomycin-D, a general inhibitor of transcription (Fig. 23 A). Treatment with T3 for 4 h caused a detectable increase of alien mRNAs (Fig. 23 B). Incubation with cycloheximide alone was able to induce alien mRNA levels, showing that this induction has characteristics similar to those found for different early response genes, that have transcripts with short half-lives in which labile proteins have been implicated (Morgan and Curran, 1995).

#### Northern blots Alien cDNA probe



**Fig. 23: Both actinomycin D and cycloheximide prevent T3-mediated alien gene induction in N2A-TR $\beta$  cells.** Neuroblastoma cells (N2A- cell line) stably expressing TR $\beta$  were treated for four hours with thyroid hormone (T3) at a final concentration of 150 nM prior harvest and analyses of Alien gene expression by Northern blotting. Total RNA was isolated and hybridized with the alien cDNA probe. Actinomycin D (2.5 mg/ml; Act-D) and cycloheximide (10 mg/ml; CHX) were added 30 min prior 4 h T3 treatment when indicated. Two alien specific messages at 2 kb and 4 kb are detected. Treatment with T3 alone provoked a visible induction of both alien mRNAs (A & B). Actinomycin D prevented this induction (A). Cycloheximide alone was able to induce alien gene expression in absence of hormone (B). Addition of T3 was not able to induce further alien RNA. The lower panels (A & B) show the RNA signal upon hybridization with radioactive cyclophilin probe (Cy) as loading control.

In concordance, preliminary results investigating the stability of Alien mRNAs indicated a rapid decay rate. Hormone administration was not able to induce further alien expression in the presence of cycloheximide.

The data may imply that alien gene expression harbors some of the characteristic of early response genes. In addition, these findings indicate that activation of alien

expression likely represents an indirect effect of the T3 receptor, which requires previous *de novo* synthesis of a protein or proteins.

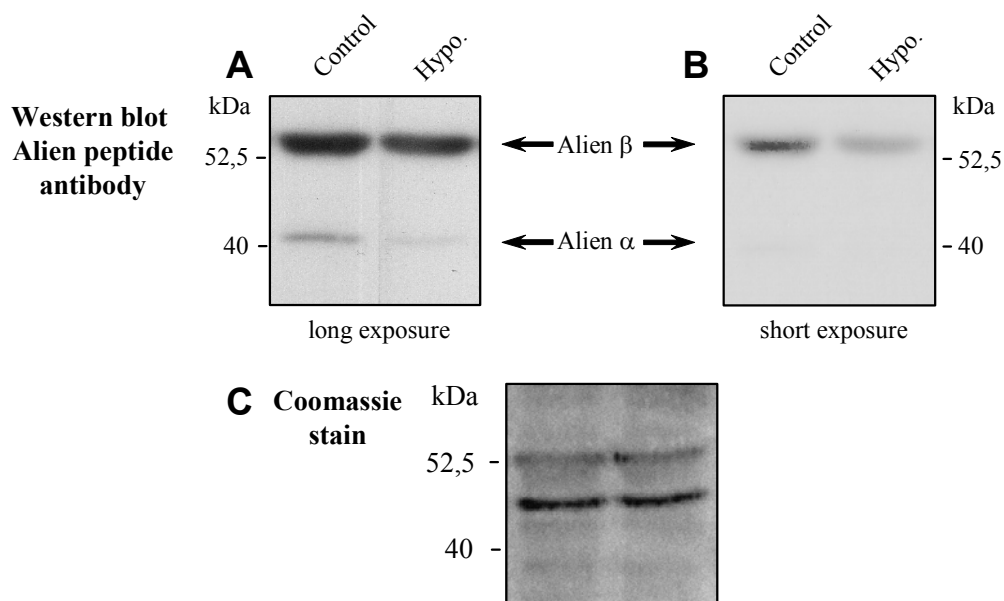
### **5.2.11 Alien protein is induced by thyroid hormone *in vivo* and in TR expressing cells**

The next question to address was whether the induction of alien mRNA upon T3 treatment *in vivo* and in cell culture is reflected in Alien protein levels. To test this, first protein extracts from euthyroid and hypothyroid rat brain were tested in Western blot experiments with anti-Alien peptide antibody (Dressel *et al.*, 1999). The anti-Alien peptide antibody detects two bands: A weaker band migrating at about 41 kDa and a stronger band at 54 kDa, respectively (Figs. 24 A & B). This is in line with the two Alien protein isoforms  $\alpha$  and  $\beta$  known to date. Both Alien protein bands are reduced in hypothyroid compared to euthyroid (control) rat brain, while the Coomassie-stained PVDF membrane shows equal loading as control (Fig. 24 C). Lower levels of Alien protein in hypothyroid animals are in accordance with the lower alien mRNA levels detected in Northern and *in situ* experiments.

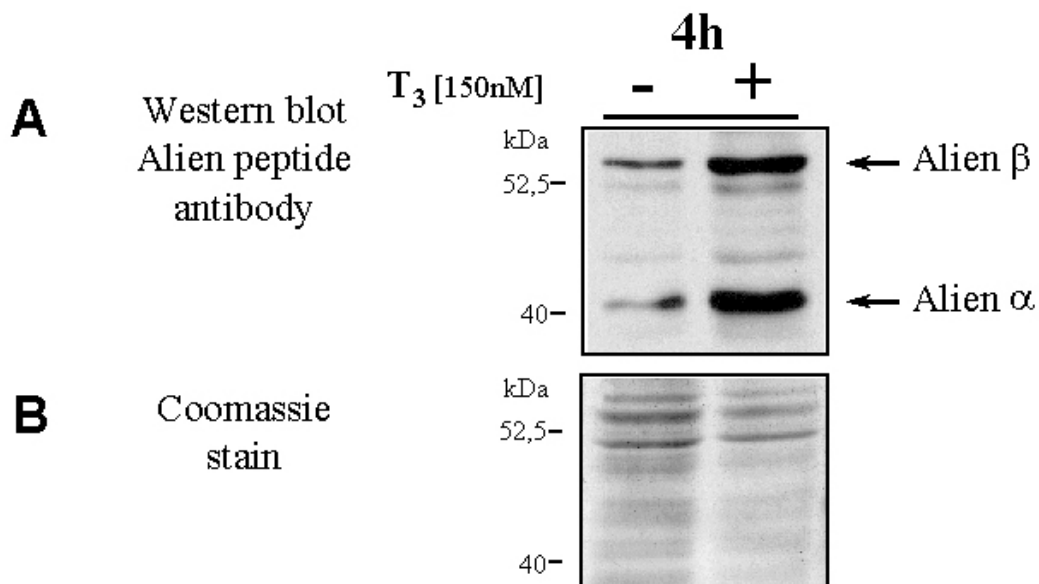
Thus, anti-Alien antibody recognized two bands that exhibit reduced expression in hypothyroid rat brain.

Similar experiments were performed with N2A neuroblastoma cells expressing TR $\beta$  (Fig. 25 A; Lebel *et al.*, 1994). Western analyses with anti-Alien peptide antibody revealed also two detected bands in these cells. In contrast to the primary brain tissue, the lower migrating band at 41 kDa (Alien $\alpha$ ) is much stronger present compared to the slower migrating band at 54 kDa (Alien $\beta$ ). Comparing the expression with and without thyroid hormone treatment, both prominent bands detected by the Alien antibody show a strong induction after thyroid hormone treatment (Fig. 25 A).

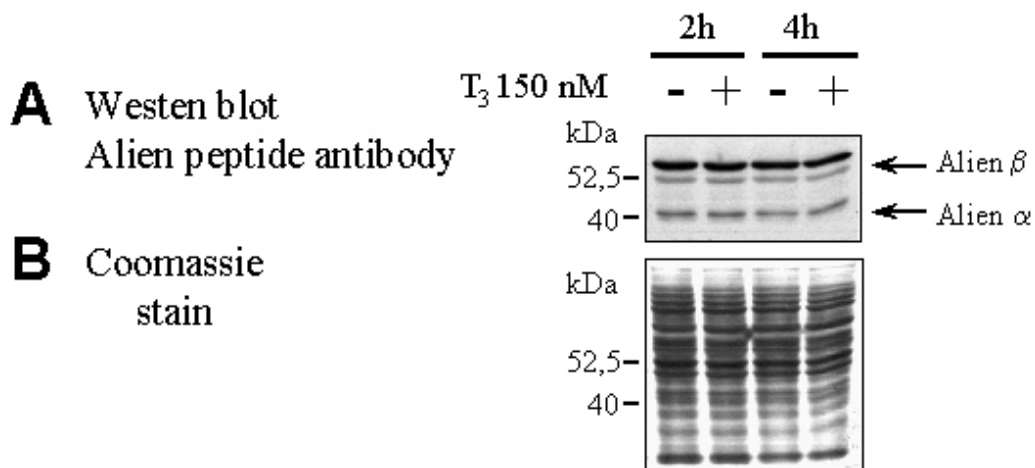
As control, the parental neuroblastoma cells lacking significant amounts of functional TRs were tested (Fig. 26 A). These cells lack T3 mediated induction of Alien protein. As loading control, the Coomassie staining of the PVDF membrane is shown (Fig. 26 B). Thus, both detected Alien protein isoforms are induced by T3 in neuroblastoma cells by each of the thyroid hormone receptor isoforms.



**Fig. 24: Alien  $\alpha$  and Alien  $\beta$  are down regulated in brain tissue from hypothyroid rats.** Total protein isolated from rat brain of control or hypothyroid animals was analyzed by Western blotting with the anti-Alien antibody. Two bands are detected migrating at about 41 kDa (Alien $\alpha$ ) and 54 kDa (Alien $\beta$ ), respectively (A & B; arrows). Levels of both Alien protein isoforms were lower in hypothyroid brain. As loading control, the Coomassie stained PVDF-membrane is shown (C).



**Fig. 25: Alien proteins are induced by T3 in N2A-TR $\beta$  cells.** (A) Total protein, isolated from N2A neuroblastoma cells stably expressing TR $\beta$  treated or not with 150 nM T3 for four hours, was analyzed by Western blotting with the anti-Alien antibody. Two bands migrating at about 41 kDa (Alien $\alpha$ ) and 54 kDa (Alien $\beta$ ), respectively, are detected. Upon hormone treatment, a strong induction of both Alien protein isoforms is observable. As loading control the Coomassie-stained PVDF-membrane is shown (B).



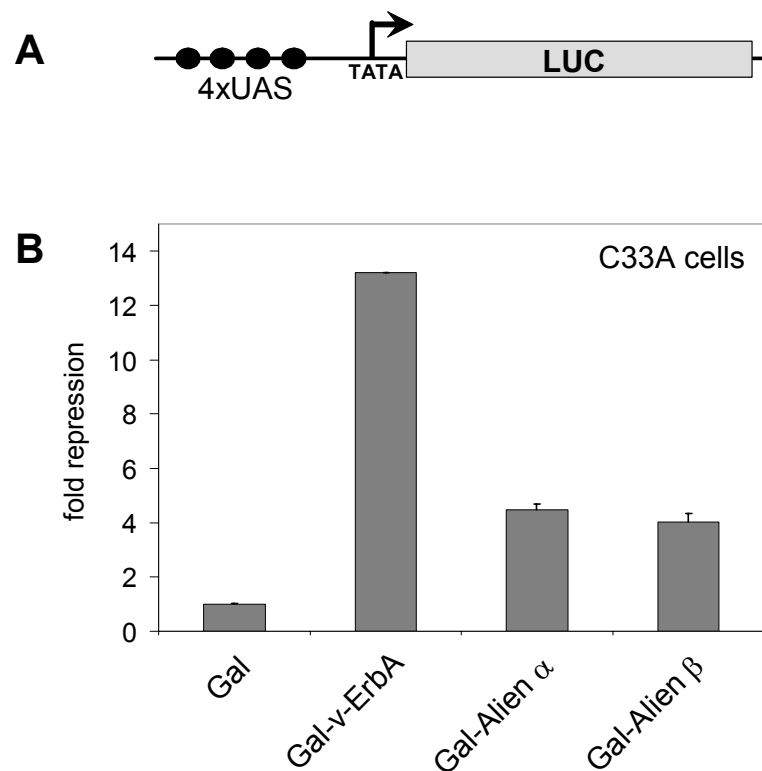
**Fig. 26: Alien proteins are not induced by T3 in N2A parental cell line, lacking thyroid hormone receptors.** (A) Total protein isolated from parental N2A cells treated or not with T3 for two and four hours was analyzed by Western blotting with the anti-Alien antibody. Two bands migrating at about 41 kDa (Alien $\alpha$ ) and 54 kDa (Alien $\beta$ ), respectively, are detected. Thyroid hormone induced neither of the two Alien protein isoforms. As loading control the Coomassie-staining of the same PVDF-membranes is shown (B).

### 5.3 Functional characterization of Alien $\alpha$ and Alien $\beta$ isoforms

#### 5.3.1 Both Alien $\alpha$ and Alien $\beta$ silence transcription when tethered to DNA

Alien $\alpha$  has been characterized as a corepressor for thyroid hormone receptors (Dressel *et al.*, 1999). One feature of corepressors is to harbor an autonomous silencing domain. Alien $\alpha$  was shown to silence transcription when tethered to DNA. To compare the ability of Alien $\alpha$  and Alien $\beta$  referring to mediate silencing, the cDNA of hAlien $\beta$  (CSN2) was fused in frame to the DNA binding domain (DBD) of the yeast Gal4 protein (pSG424-PUC-CSN2; chapter 5.1.2). As reporter served the plasmid 4xUAS-TATA-LUC harboring four copies of the Gal4 DNA binding sequence ("UAS", upstream activating sequence) upstream of a minimal promoter and the luciferase reporter gene. The influence of Gal-hAlien $\beta$  on promoter activity was compared to that of Gal-Alien $\alpha$  in C33A cells. As a positive control, the plasmid pAB-gal-v-erbA<sub>362</sub> (Baniahmad *et al.*, 1992) coding for the GAL4-DBD-fused silencing domain of the v-erbA oncogene (aa 362-639; Gal-v-ErbA) was chosen. The plasmids coding for Gal-hAlien $\beta$ , Gal-hAlien $\alpha$  or the positive control were transfected together with the reporter

plasmid in C33A cells. Measurement of the luciferase activity in transfected cells revealed that Gal-Alien $\beta$  represses the promoter activity about four fold (Fig. 27). The repression by Gal-Alien $\alpha$  was 4.5 fold. Hence, both Alien $\alpha$  and Alien $\beta$  repress promoter activity to a similar extent in C33A cells. Thus, Alien $\beta$  contains an autonomous silencing domain as shown for Alien $\alpha$  (Dressel *et al.*, 1999).

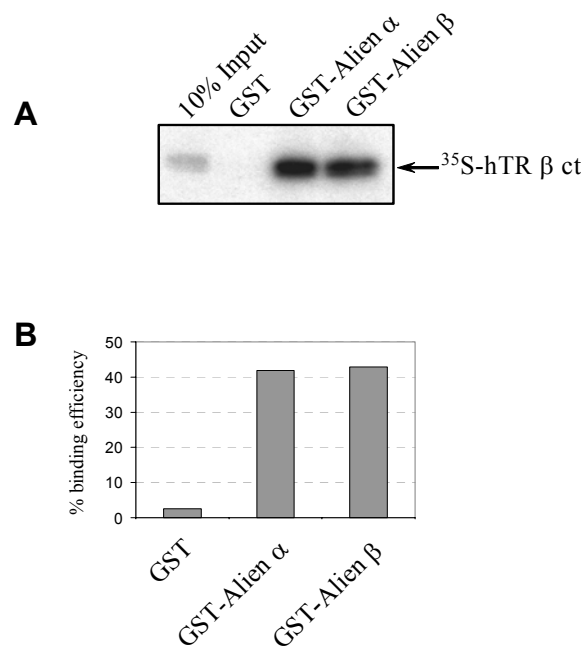


**Fig 27: Both Alien $\alpha$  and Alien $\beta$  silence transcription when tethered to DNA.** 1  $\mu$ g of each of the plasmids pSG424 (Gal), pAB-gal-erbA<sub>362</sub> (Gal-v-ErbA), pAB-gal-Alien $\alpha$  (Gal-Alien $\alpha$ ) and pSG424-PUC-CSN2 (Gal-Alien $\beta$ ) were transiently transfected together with 1.5  $\mu$ g of the reporter plasmid 4xUAS-TATA-LUC (A) and a pCMV- $\beta$ -gal plasmid, as internal control, in C33A cells. The cells were harvested after two days; luciferase activity was measured and normalized to total protein amount and  $\beta$ -gal activity of the extracts. (B) Basal activity of pSG424 was set to one and the relative fold repression was calculated.

### 5.3.2 Both GST-Alien $\alpha$ and GST-Alien $\beta$ interact with *in vitro*-translated hTR $\beta$ -ct in GST-pulldown

Since Alien $\alpha$  exerts its function as a corepressor by direct interaction with the carboxyl terminus of TR in absence of T3 (Dressel *et al.*, 1999), it was now of interest to test whether Alien $\beta$  is also able to interact directly with the thyroid hormone receptor.

These interactions were studied using the GST-pulldown assay with bacterially expressed GST-fusion proteins of either Alien $\alpha$  (pGST-hAlien $\alpha$ ; Dressel *et al.*, 1999 or pGST-hAlien $\beta$ ; Baniahmad) and the *in vitro*-translated hTR $\beta$  C-terminus (pT7-hTR $\beta$ -ct, Baniahmad *et al.*, 1993). As expected GST-Alien $\alpha$ , but also GST-Alien $\beta$  directly interact with hTR $\beta$ -ct in absence of hormone. The high binding efficiency of the interaction with hTR $\beta$ -ct was nearly equal (about 40%) for both, Alien $\alpha$  and Alien $\beta$ . Thus, also the Alien $\beta$  isoform is able to interact with the thyroid hormone receptor as shown for the corepressor Alien $\alpha$ .

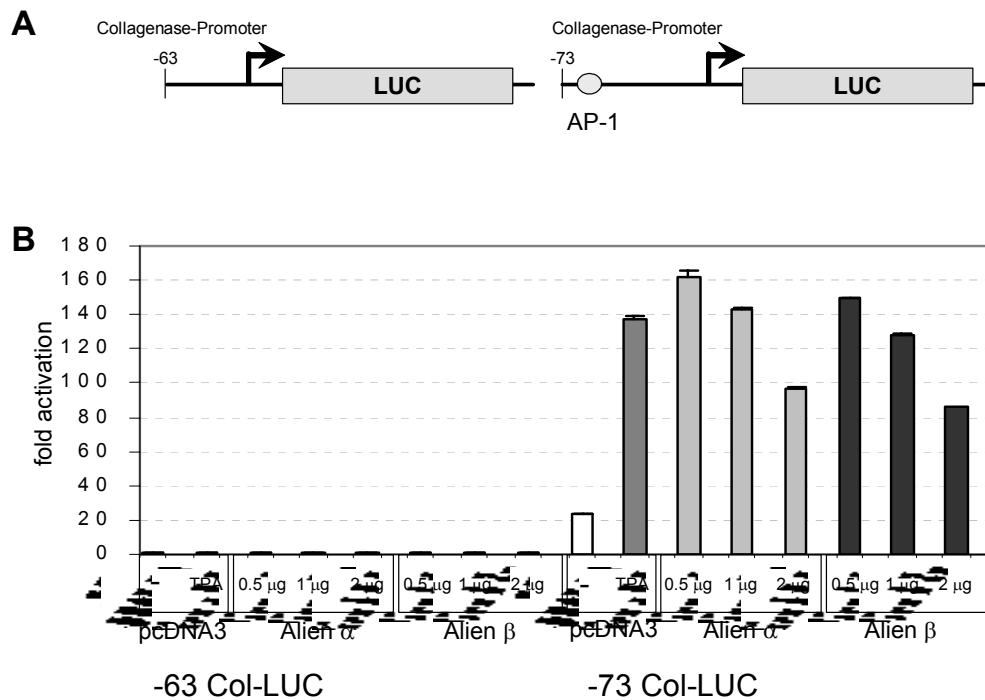


**Fig. 28: Both GST-Alien $\alpha$  and GST-Alien $\beta$  interact with *in vitro*-translated hTR $\beta$ -ct in GST-pulldown.** The  $^{35}\text{S}$ -labeled product of *in vitro*-translated pT7-hTR $\beta$ -ct was incubated with bacterially expressed and affinity purified GST (as control), GST-Alien $\alpha$  and GST-Alien $\beta$  to perform this GST-pulldown experiment (see materials and methods). (A) Co-purified proteins and 10% of the *in vitro* translation reaction (10% Input) were separated by SDS-PAGE and visualized by autoradiography. (B) % binding efficiency was calculated via densitometric quantification of the radiography.

### 5.3.3 Alien $\alpha$ as well as Alien $\beta$ stimulates AP1 mediated transcription in a dose dependent manner in HeLa cells

Naumann and coworkers described a dose dependent effect of Alien $\beta$  (CSN2) on AP1-mediated transcription in HeLa cells (Naumann *et al.*, 1999). They linked this effect to a kinase activity associated to the COP9-signalosome (CSN). Since overexpression of hAlien $\beta$  (CSN2) caused an increase in the number of CSN complexes in HeLa cells, the authors proposed an increase of CSN activities. In consequence, augmented CSN-mediated phosphorylation of c-jun would lead to stabilization of this transcription factor and resulted in elevated transcriptional activity of AP1 (Naumann *et al.*, 1999). The question to address here was whether Alien $\alpha$  also influences AP1 mediated transcription. Therefore, increasing amounts of expression plasmids coding for Alien $\alpha$  as well as Alien $\beta$  were cotransfected with an AP1-LUC reporter in HeLa cells. As a positive control mock transfected HeLa cells were treated or not with TPA, known to stimulate AP1-driven transcription (Angel *et al.*, 1988). Transcriptional effects, measured by luciferase activity were normalized to a reporter construct lacking the AP1 binding site (-63-Col-LUC). Transfection of 0.5  $\mu$ g of Alien $\beta$  expression plasmid strongly activated AP1-driven transcription (150 fold; 6.4 fold respective to basal AP1 activation) to a similar extent as TPA (138 fold; 6 fold), as expected. Increasing amounts of overexpressed Alien $\beta$  (1  $\mu$ g and 2  $\mu$ g) lowered this Alien $\beta$ -mediated AP1 activation to 128 fold (5.5 fold) and 85 fold (3.6 fold), respectively. Interestingly, overexpression of Alien $\alpha$  activated the AP1-LUC construct slightly stronger (162 fold; 7 fold) than Alien $\beta$  (Fig. 29). Transfection of higher amounts of Alien $\alpha$  expression plasmid (1  $\mu$ g and 2  $\mu$ g) also diminished the activation of AP1 to 143 and 97 fold (6.1 and 4 fold). Thus, interestingly, the effect of Alien $\alpha$  on AP1-mediated transcription followed the same pattern than Alien $\beta$ . This is a surprising finding, because Alien $\beta$  is thought to be integrated into the COP9-signalosome through its C-terminal PCI-domain (Seeger *et al.*, 1998), a domain absent in the Alien $\alpha$  protein. Consequently, it is hypothesized that Alien $\alpha$  would not be integrated in the CSN. Therefore, these results raise the question if molecular mechanisms leading to Alien-mediated activation of AP1 are dependent or independent of the CSN. Alien $\alpha$  and Alien $\beta$  may participate in those processes as integrated CSN subunits or as CSN unrelated proteins.

Hence, Alien $\alpha$  induces AP1-mediated transactivation similar to Alien $\beta$ .



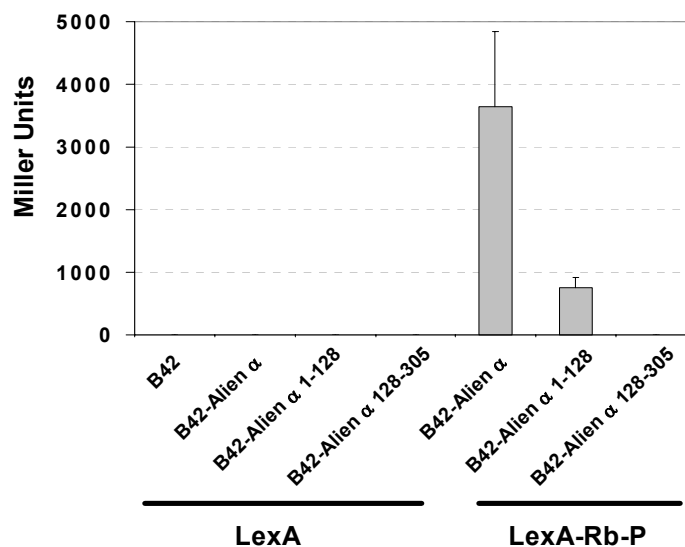
**Fig. 29: Alien $\alpha$  as well as Alien $\beta$  stimulate AP1 mediated transcription in a dose dependent manner in HeLa cells.**  $1.6 \times 10^6$  HeLa cells were transfected transiently with mammalian plasmids coding for Alien $\alpha$  (pAB-TRIP15 $\Delta$ gal) and Alien $\beta$  (pcDNA3-CSN2) together with the human collagenase promoter reporter plasmids -73-Col-LUC or -63-Col-LUC, containing or not the AP1 binding site, as indicated in (A). The calcium phosphate-method, described in material and methods, was used. As internal control for transfection efficiency served a pCMV- $\beta$ -gal plasmid. Amounts of transfected plasmids were equalized with empty vector (pcDNA3). Mock (pcDNA3) transfected cells were treated or not with a final concentration of 10 nM TPA 12 h before cell harvesting to stimulate AP1 transcription. The luciferase activity was measured two days after transfection and normalized to total protein amount and  $\beta$ -gal activity of the extracts. The basal activity of mock transfected -63-Col-LUC without TPA treatment was set as one. Relative to that fold activation was calculated and is displayed in (B).

#### 5.3.4 Alien $\alpha$ interacts with hRb through its N-terminus in the yeast-two-hybrid system

The search for possible interaction of Alien $\alpha$  with other silencer proteins using the yeast-two-hybrid system lead to the identification of the human retinoblastoma tumor suppressor gene product (Rb) as a novel Alien interacting factor. For that purpose, the pocket domain of Rb was fused to the LexA-DBD in a yeast expression vector (Rb-P, aa 379-792, small pocket). This fusion protein interacts efficiently with full length Alien $\alpha$  (Fig. 30). To narrow down the interaction domain, deletion mutants of Alien $\alpha$  were tested for interaction with Rb-P. The first 128 N-terminal amino acids of Alien $\alpha$



(pJG-TRIP15<sub>1-128</sub>; Altincicek *et al.*, 2000) still interacted with Rb-P in yeast, whereas a mutant harboring Alien $\alpha$  amino acids 128-305 (pJG-TRIP15<sub>128-305</sub>; Altincicek *et al.*, 2000) did not bind the Rb pocket domain. These data suggest that the corepressor protein Alien $\alpha$  interacts with the silencing domain of the retinoblastoma protein through its N-terminus in yeast.

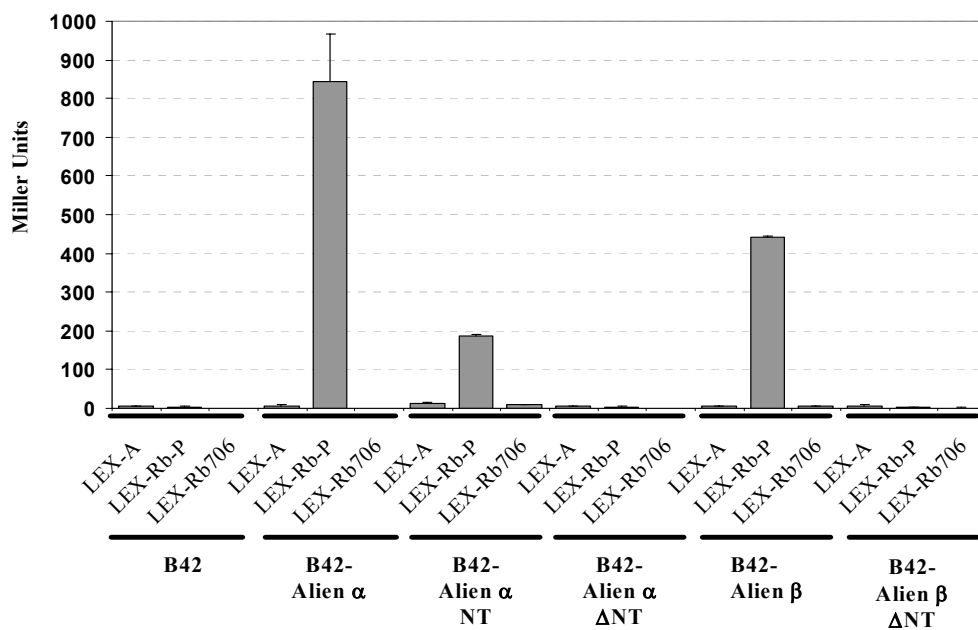


**Fig 30: Alien $\alpha$  interacts with hRb through its N-terminus in the yeast-two-hybrid system.** The indicated combinations of yeast expression plasmids pEG-term (Lex-A) and pEG-term-Rb-P<sub>neu</sub> (LexA-Rb-P) as baits and pJG-4-5 (B42), pJG-TRIP15 (B42-Alien $\alpha$ ), pJG-TRIP15<sub>1-128</sub> (B42-Alien $\alpha$  1-128) and pJG-TRIP15<sub>128-305</sub> (B42-Alien $\alpha$  128-305) as activators were co-transformed together with the  $\beta$ -gal reporter plasmid pSH-18-34 in the yeast strain EGY48.  $\beta$ -gal activity was measured and Miller Units were calculated.

### 5.3.5 The N-termini of both Alien $\alpha$ and Alien $\beta$ , are required for interaction with hRb in the yeast-two-hybrid system – mutation of the hRb pocket domain abolishes these interactions

Next it was interesting to investigate whether Alien $\beta$  is able to interact as well with the retinoblastoma protein. Furthermore, it should be tested if a natural occurring point mutation in the pocket domain of Rb (C706F; Kaye *et al.*, 1990), that abolishes silencing activity of Rb (Weintraub *et al.*, 1995; Adnane *et al.*, 1995) would interact with Alien proteins. Alien $\alpha$  interacts with Rb-P but curiously not with Rb-706. The first

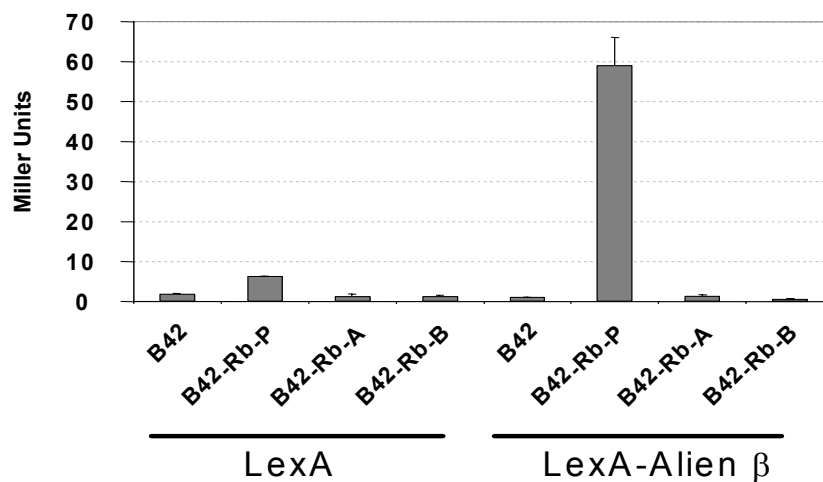
66 N-terminal amino acids of Alien $\alpha$  (Fig. 31, B42–Alien $\alpha$ -NT) showed similar binding characteristics with Rb. Deletion of these first 66 amino acids of Alien $\alpha$  abolished its Rb-binding capability (Fig. 31, B42–Alien $\alpha$  $\Delta$ NT). Interestingly, also Alien $\beta$  bound to Rb-P in this experiment, whereas the C706F mutation abolished interaction to Alien $\beta$ , too (Fig. 31; B42–Alien $\beta$ ). In line with that, an Alien $\beta$  N-terminal deletion mutant interacted either with Rb-P in yeast (Fig. 31, B42–Alien $\beta$  $\Delta$ NT; aa 130–444). Thus, Alien $\alpha$  as well as Alien $\beta$  interact with the silencing domain (small pocket domain) of the retinoblastoma protein through their N-termini in yeast. Additionally, the mutated Rb pocket domain (C706F), that prevents Rb-mediated transcriptional silencing, abolishes the ability to bind to both Alien isoforms.



**Fig. 31: The N-termini of both Alien $\alpha$  and Alien $\beta$ , are required for interaction with hRb in the yeast-two-hybrid system - The C706F mutation of the hRb pocket domain abolishes these interactions.** The indicated combinations of yeast expression plasmids pEG-term (LEX-A), pEG-term-Rb-P<sub>neu</sub> (LEX-A-Rb-P) and pEG-term-Rb<sub>706</sub> (LEX-A-Rb706, carrying the C706F point mutation) as baits and pJG-4-5 (B42), pJG-TRIP15 (B42-Alien $\alpha$ ), pJG-TRIP15<sub>1-66</sub> (B42-Alien $\alpha$ -NT), and pJG-TRIP15<sub>66-264</sub> (B42-Alien $\alpha$ - $\Delta$ NT), as well as pJG-CSN2 (B42-Alien $\beta$ ) pJG-CSN2 $\Delta$ -NT (B42-Alien $\beta$ - $\Delta$ -NT, aa130–444) as activators were cotransformed together with the  $\beta$ -gal reporter plasmid pSH-18-34 in the yeast strain EGY48.  $\beta$ -gal activity was measured and Miller Units were calculated. This experiment was performed in collaboration with Maren Eckey (Giessen, Germany).

### 5.3.6 The entire small pocket domain of hRb is necessary for interaction with Alien $\beta$ in yeast, as shown for Alien $\alpha$

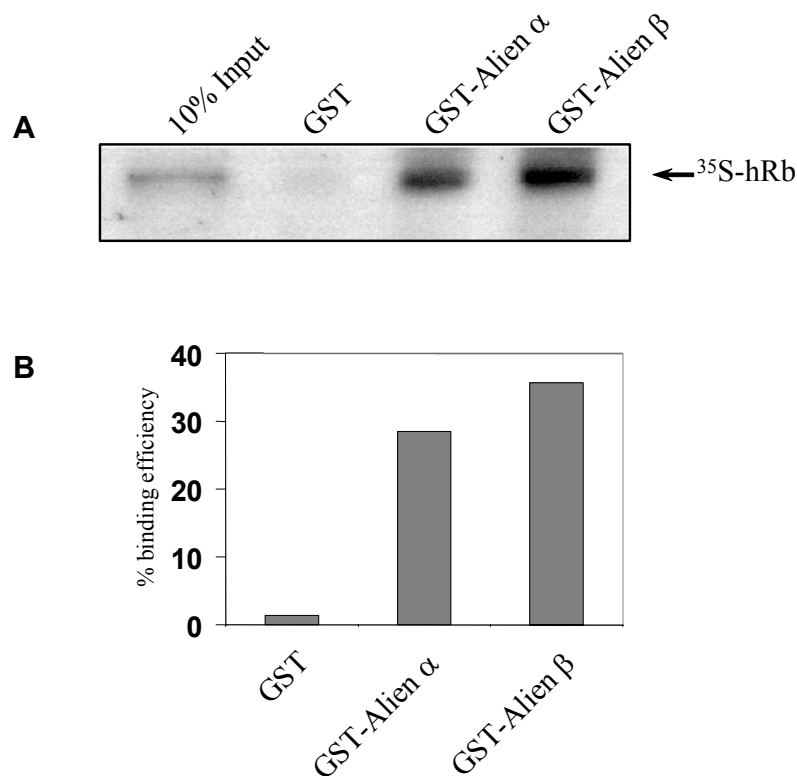
The Retinoblastoma silencing domain (small pocket) is composed of two sub-domains, namely the A domain (aa 395-571; A-pocket) and the B domain (aa 649-773; B-pocket) separated by a spacer peptide (aa572-648) Weintraub *et al.*, 1995 Adnane *et al.*, 1995. Unpublished studies performed by B. Altincicek (A. Baniahmad's laboratory) proofed that Alien $\alpha$  requires the entire Rb pocket domain as interaction surface (unpublished data). To analyze the interaction domains of Rb with Alien $\beta$  a yeast-two-hybrid assay was performed using deletion mutants of Rb-P coding either for the A or the B domain alone fused to the B42 activation domain. Alien $\beta$  interacted with the Rb pocket domain, but that none of the two Rb-pocket sub-domains alone was sufficient to establish interaction with Alien $\beta$  (Fig. 32). Thus, Alien $\beta$  requires the entire Rb pocket domain as interaction surface, similar to that shown for Alien $\alpha$



**Fig. 32: The entire small pocket domain of hRb is necessary for interaction with Alien $\beta$  in yeast, as shown for Alien $\alpha$ .** This yeast-two-hybrid assay was carried out as described before. The indicated combinations of yeast expression plasmids coding for LexA (pGILDA) and LexA-Alien $\beta$  (pGIL-CSN2) as baits and B42 (pJG-4-5), B42-Rb-P (pJG-Rb-P) as well as B42-Rb-A (pJG-Rb-A) and B42-Rb-B (pJG-Rb-B) were transformed together with the  $\beta$ -gal reporter pSH-18-34 in the yeast strain EGY48.  $\beta$ -gal activity was measured and Miller Units were calculated.

### 5.3.7 Both Alien $\alpha$ and Alien $\beta$ interact with *in vitro* translated hRb in GST-pulldown

In order to confirm the interaction of Alien $\alpha$  and Alien $\beta$  with the retinoblastoma protein, as assessed by the yeast-two-hybrid assays, GST-pulldown experiments using bacterially expressed GST-Alien isoforms and *in vitro* translated retinoblastoma full length protein were performed. GST-Alien $\alpha$  as well as GST-Alien $\beta$  binds *in vitro* translated full length Rb with comparable binding efficiencies (Fig. 33).



**Fig. 33: Both Alien $\alpha$  and Alien $\beta$  interact with *in vitro* translated hRb in GST-pulldown.** This GST-pulldown assay was performed with human full length Rb protein *in vitro*-translated in presence of  $^{35}\text{S}$ -Methionine using the plasmid pCITE-Rb.  $^{35}\text{S}$ -Rb was incubated with bacterially expressed and affinity purified GST (as control), GST-Alien $\alpha$  and GST-Alien $\beta$ . After extensive washing steps the co-purified proteins and 10% of the translation reaction (10% Input) were separated by SDS-PAGE and visualized by autoradiography (A). Densitometric quantification of the obtained signals permitted to calculate the binding efficiency (%).

### 5.3.8 GST-hRb<sub>379-928</sub> interacts with both Alien $\alpha$ and Alien $\beta$ *in vitro*

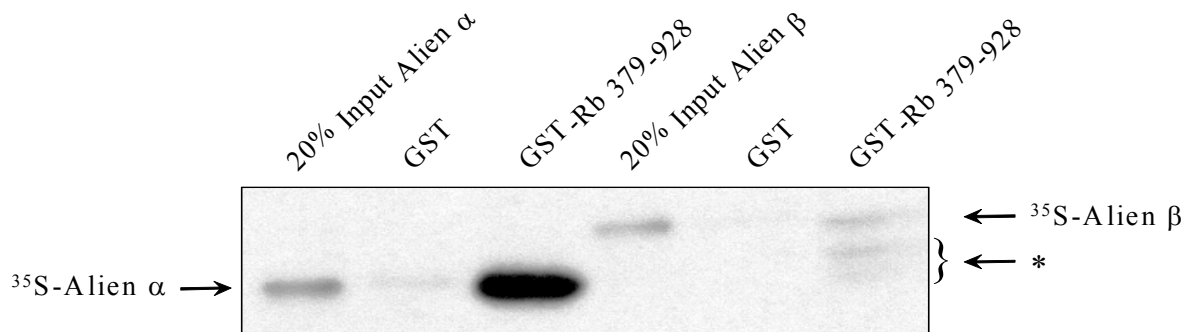
To analyze potential post-translational modifications a GST-pulldown using the bacterially expressed Rb C-terminal part (GST-Rb<sub>379-928</sub>; large pocket), that includes the entire A-B-C-pocket domain, as well as *in vitro*-translated Alien $\alpha$  and Alien $\beta$  was

performed. Reticulocytes should contain all cellular components. Consequently, post-translational modifications, such as phosphorylation, of proteins translated *in vitro* are possible using this method ([Gibbs, 1985 #389; Pollard *et al.*, 1990; Hennessey, 1991 #388]). Under these experimental conditions Alien $\alpha$  strongly bound to GST-Rb<sub>379-928</sub>. However, interaction of Alien $\beta$  with Rb was weaker than that of Alien $\alpha$ . Also Alien $\beta$  specific degradation products appeared in this assay ("\*", Fig. 34). Interestingly, also the Alien $\beta$  specific degradation products still interacted with Rb. Since the interaction domain of Alien with Rb lays in the 66 most N-terminal amino acids of Alien isoforms (Figs. 30, 31; Altincicek unpublished data), these results suggest the possibility of carboxyl-terminal proteolysis. Additionally, the finding that bacterially expressed Alien $\beta$  strongly interacts with *in vitro*-translated Rb but interaction is weaker, if the experiment is performed with GST-Rb and *in vitro*-translated Alien $\beta$ , suggests that post-translational modifications may influence this interaction. Within this hypothesis, it would be possible that post-translational modification of *in vitro*-translated Rb may enhance binding to recombinant Alien $\beta$  or modification of *in vitro*-translated Alien $\beta$  may hinder interaction with GST-Rb. Furthermore, involvement of other proteins present in reticulocyte lysate can not be ruled out. Taking together, these results confirm that both Alien $\alpha$  as well as Alien $\beta$  form complexes with the human retinoblastoma protein *in vitro*.

### 5.3.9 Alien $\beta$ , but not Alien $\alpha$ , influences hRb-mediated transcriptional activation

To investigate whether Alien protein isoforms influence Rb-mediated transcription *in vivo*, transient transfection assays in cultured cells were set up. The Rb protein has been shown to act positively or negatively on transcriptional regulation of multiple cellular genes (Morris and Dyson, 2001). In CV1 cells, the Gal4-fused retinoblastoma protein represses transcription when tethered to DNA (Adnane *et al.*, 1995).

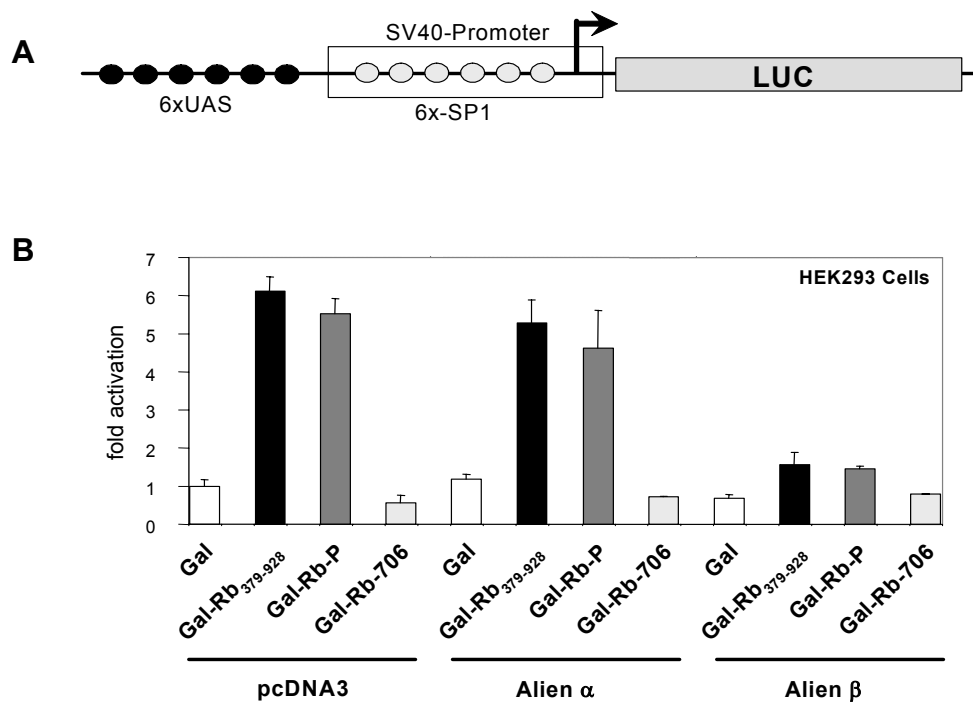
The influence of different Gal4-fused Rb constructs on promoter activity was measured in absence and presence of Alien $\alpha$  and Alien $\beta$  expression vectors in C33A cells, lacking endogenous expression of functional Rb (Scheffner *et al.*, 1991). Plasmids coding for Gal-Rb-P (aa 379-792), for the large pocket of the Rb protein (GAL-RB<sub>379-928</sub>) and for the large pocket carrying the C706F point mutation (GAL-Rb-706) were transfected into C33A cells together with several UAS-LUC reporter constructs.



\* Alien  $\beta$  specific degradation

**Fig. 34: GST-hRb<sub>379-928</sub> strongly interacts with *in vitro* translated Alien $\alpha$  and weakly with *in vitro* translated Alien $\beta$  in GST-pulldown.** <sup>35</sup>S labeled Alien $\alpha$  translated *in vitro* from the plasmid pT7-TRIP15 and radioactive Alien $\beta$  *in vitro*-translated using pcDNA3-CSN2 were incubated with bacterially expressed and affinity purified GST-hRb<sub>379-928</sub> in this GST-pulldown assay. Co-purified proteins were subjected to SDS-PAGE and detected by autoradiography. Arrows indicate the position of Alien protein isoforms and "\*" marks the Alien $\beta$  specific degradation product.

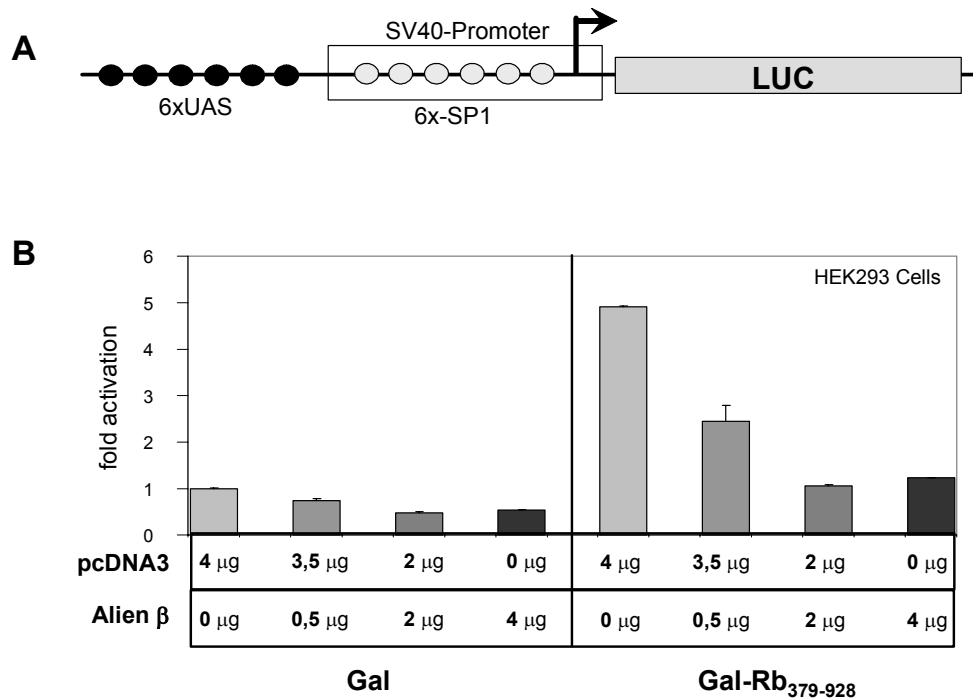
As expected, Gal-Rb-P and GAL-Rb<sub>379-928</sub> repressed promoter activities of UAS-SV40-LUC (3 fold), UAS-E1B-LUC (3 fold) and UAS-TATA-LUC (5fold), whereas GAL-Rb-706 failed to repress these luciferase reporters (data not shown). Neither cotransfection of Alien $\alpha$  nor Alien $\beta$  influenced significantly Gal-Rb mediated silencing. To test whether the failure of Alien isoforms to influence Rb mediated repression depends on the cell type, the same experiment was set up in HEK293 cells. Comparable results were obtained using the UAS-E1B-LUC and UAS-TATA-LUC reporter plasmids (data not shown), suggesting that at least under these experimental conditions neither Alien $\alpha$  nor Alien $\beta$  interfered with repression by Rb. Surprisingly, using the UAS-SV40-LUC reporter, containing the SV40-early promoter, in HEK293 cells, the Gal-Rb-P construct as well as GAL-RB<sub>379-928</sub> activated transcription 5-6 fold, instead of repressing it as expected (Fig. 35). Gal-Rb-706 failed to activate UAS-SV40 driven luciferase gene transcription. Interestingly, coexpression of Alien $\alpha$  did not alter the observed transactivation, whereas Alien $\beta$  nearly abolished it (Fig. 35).



**Fig. 35: hRb but not the mutant Rb-C706F is able to activate transcription of a SV40-LUC reporter construct in HEK293 cells – Alien $\beta$  but not Alien $\alpha$  abolishes this activation.**  $1.8 \times 10^6$  HEK293 cells were transiently transfected with the displayed combinations of 1  $\mu$ g of each GAL-fusion plasmid (pM2 (Gal); pM2-Rb (Gal-Rb<sub>379-928</sub>); pM2-Rb-P (Gal-Rb-P); pM2-Rb-706 (Gal-Rb-706)) and 2  $\mu$ g of pcDNA3, pAB-hAlien $\alpha$  (Alien $\alpha$ ) or pcDNA3-CSN2 (Alien $\beta$ ) when indicated. 0.75  $\mu$ g of the 6xUAS-SV40-LUC construct displayed in (A) and 0.5  $\mu$ g a pCMV- $\beta$ -gal plasmid cotransfected to each of the indicated plasmid combinations served as reporter or internal transfection control, respectively. Cells were harvested two days after transfection; the luciferase activity was measured and normalized to total protein amount and  $\beta$ -gal activity of the extracts. The luciferase activity of the samples transfected with Gal and pcDNA3 were set as one and fold activation was derived.

Coexpression of increasing amounts of Alien $\beta$  with Gal-Rb<sub>379-928</sub> demonstrated a stepwise reduction of Gal-Rb-mediated activation of the UAS-SV40-LUC construct (Fig. 36). Increasing amounts of Alien $\alpha$  expression plasmid did not abolish the Rb dependent activation (data not shown).

Thus, the silencing domain of the retinoblastoma protein activates transcription on the SV40-early promoter in HEK293 but not in C33A cells, suggesting the participation of cell type specific factors. Alien $\beta$  but not Alien $\alpha$  abolishes this transactivating effect in a dose dependent manner.



**Fig. 36: Interference of Alienβ with Rb-mediated superactivation of Sp1 is dose dependent.**  $1.8 \times 10^6$  HEK293 cells were transiently transfected with 1 μg of pM2 (Gal) or pM2-Rb (Gal-Rb<sub>379-928</sub>) as well as with the indicated amounts of pcDNA3 and pcDNA3-CSN2 (Alienβ). As reporter and internal control for transfection efficiency served the plasmids 6xUAS-SV40-LUC (A) and pCMV-β-gal. The cells were harvested two days after transfection and luciferase activity was measured and normalized to total protein amount and β-gal activity. Luciferase activity of mock (Gal/pcDNA3) transfected cells were set to one and fold activation was calculated.

### 5.3.10 Alienβ abolishes Rb-mediated superactivation of Sp1-driven transcription – The Rb-mutant C706F is not able to super-activate Sp1

Rb interacts with several transcription factors to modulate their activity. It is well established that binding of Rb represses E2F-transactivation of target genes depending on cell cycle state (reviewed in Harbour and Dean, 2000a). In several occasions Rb has been described to activate transcription. Rb activates e.g. the expression of the human TGF-β2 gene through interaction with the ATF-2 transcription factor (Kim *et al.*, 1992b). Furthermore, Rb is required for transcriptional activation of the transcription factor myo-D to mediate induction of myogenic differentiation (Gu *et al.*, 1993). Finally, cooperation between Rb and the transcription factor Sp1 was reported to play a role in the activation of various genes, such as c-fos, c-myc, p21<sup>WAF-1/CIP-1</sup> genes, as well



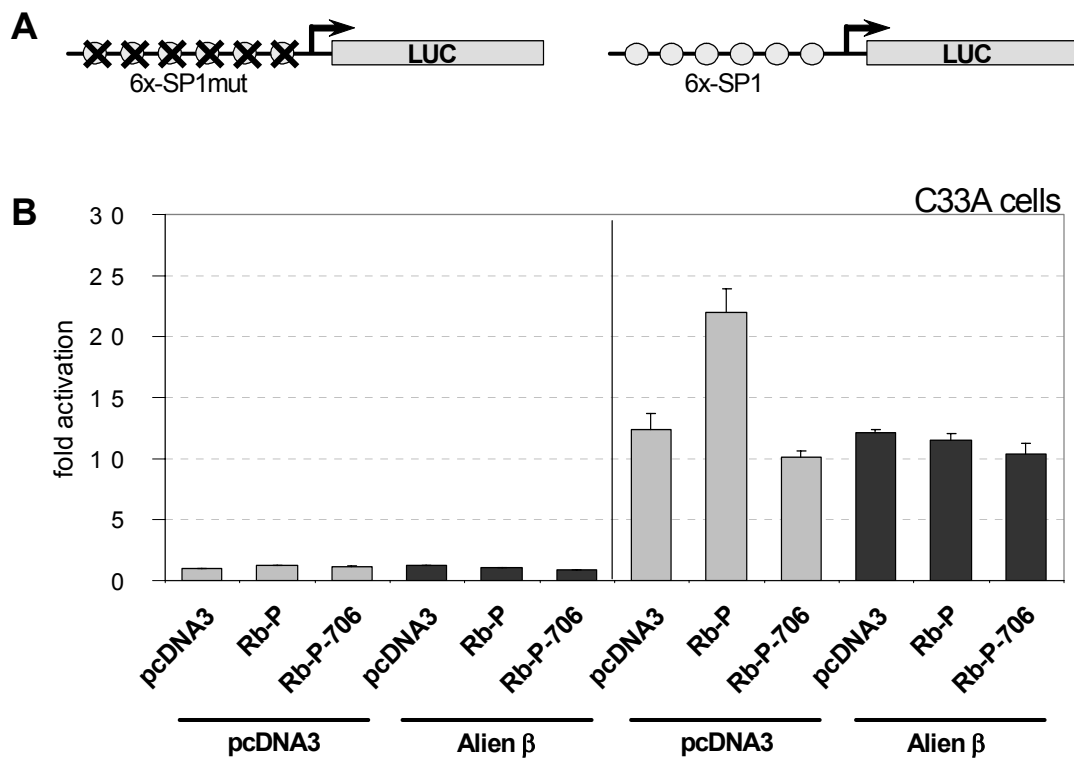
as the dihydrofolate reductase and the Werner helicase gene (Udvardia *et al.*, 1993; Yamabe *et al.*, 1998; Decesse *et al.*, 2001; Noe *et al.*, 1997; Batsche *et al.*, 1994). This transcriptional activation occurs through a mechanism that involves promoter elements called retinoblastoma control elements (RCE; Udvardia *et al.*, 1992). RCE motifs exist in most of the above mentioned genes and are bound by members of the Sp1 family of transcription factors. Rb cooperates with members of the Sp1 protein family and superactivates Sp1-mediated transactivation through a mechanism suggesting complexation of Rb with Sp1 and involvement of the basal transcription machinery (Kim *et al.*, 1992b; Udvardia *et al.*, 1993; Udvardia *et al.*, 1995; Adnane *et al.*, 1999; Siegert and Robbins, 1999), although, direct interaction of Rb and Sp1 has not been demonstrated, yet.

Since the SV40-early promoter used in the transfection assays (Figs. 35, 36) harbours six Sp1 binding sites upstream of the transcriptional start point (Barrera-Saldana *et al.*, 1985; Dynan and Tjian, 1983); superactivation of Sp1 mediated transactivation by Rb may represent a possible interpretation of the results observed here.

To gain insight in the functional interference of Alien $\beta$  with Rb on the SV40 early promoter and the possible involvement of Sp1 in this process, the influence of different Rb expression plasmids and Alien $\beta$  was tested on reporter constructs containing six Sp1 binding sites (6xSP1-LUC) or six mutated SP1 binding elements (6xSP1mut-LUC) upstream of the luciferase gene. To avoid interference of endogenous retinoblastoma protein these assays were performed in C33A cells, lacking functional Rb. Mock transfected C33A cells activated the Sp1-LUC transcription 12.5 fold, representing most probably transactivation activity of endogenous Sp1 protein family members (Fig. 37). Expression of the Rb small pocket domain (Rb-P) increased Sp1 mediated transactivation about two fold, resulting in 22 fold activation respective to the basal activity of the mutated reporter construct. This two fold effect is in line with the range of Rb mediated superactivation of Sp1 observed by others (Yamabe *et al.*, 1998; Udvardia *et al.*, 1995) and therefore, should be considered significant. Interestingly, the Rb large pocket domain carrying the C706F point mutation (Rb-706) failed to superactivate basal Sp1 activation levels, suggesting that this mutant is not able to cooperate with Sp1. This finding also could indicate that the Rb small pocket domain putatively may be the interaction surface towards Sp1. Co-transfection of Alien $\beta$  did not alter basal Sp1 activation levels, whereas superactivation by Rb-P was completely abolished (Fig. 37). In line with this notion, the Rb-C706F mutant failed to bind Alien $\beta$

in the yeast-two-hybrid system (Fig. 31) and also was not able to superactivate Sp1. None of the transfected plasmids exerted significant influence on the 6x-SP1mut-LUC reporter construct.

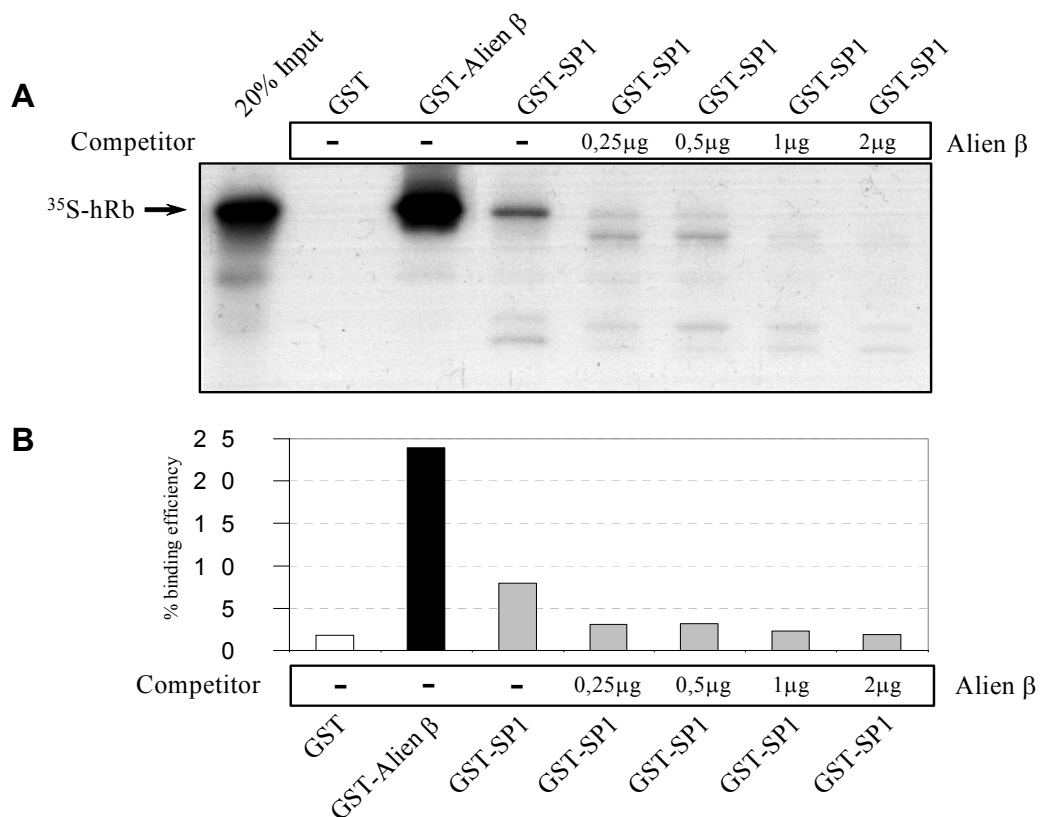
Thus, Alien $\beta$  interferes with the superactivating effect of retinoblastoma on Sp1-driven transactivation *in vivo*. The C706F-mutant of the Rb pocket domain failed to mediate superactivation.



**Fig. 37: Alien $\beta$  abolishes Rb-mediated superactivation of Sp1-driven transcription – The Rb-mutant C706F is not able to super-activate Sp1.** The influence of the indicated proteins on promoter activity of the reporter constructs pGAM (mutated Sp1-LUC) and pGAG6 (6x SP1-LUC; Biggs *et al.*, 1996) was investigated.  $1.4 \times 10^6$  C33A cells were transiently transfected with 1.5  $\mu$ g of pcDNA3, pAB-Rb-P $\Delta$ gal (Rb-P) or pAB-Rb-P-706 $\Delta$ gal (Rb-P-706), 3  $\mu$ g of pcDNA3 or pcDNA3-CSN2 (Alien $\beta$ ) and 1.5  $\mu$ g of pGAM or pGAG6 reporter as well as the internal control pCMV- $\beta$ -gal. The cells were harvested two days after transfection and luciferase activity was determined and corrected with total protein amount and  $\beta$ -gal activity. Mock transfected samples were set to one and fold activation was derived (B).

### 5.3.11 Sp1 interacts directly with Rb in GST-pulldown – Alien $\beta$ interferes with this interaction

Since Alien interacted directly with Rb in both the yeast-two-hybrid system and in GST-pulldown, it may be hypothesized that Alien $\beta$  may interfere with Sp1-Rb binding by competition for the Rb pocket domain, that may represent the putative common interaction surface, as suggested by the previous experiment. To study this mechanism in more detail, GST-pulldown-competition assays were performed. Bacterially expressed GST-Sp1 was tested for interaction with *in vitro* translated Rb alone and in presence of increasing amounts of recombinant Alien $\beta$  protein. As a positive control served the already proofed interaction of GST-Alien $\beta$  with Rb., This experiment demonstrates for the first time direct physical interaction of Rb with SP1 (Fig. 38; 8% binding efficiency). Rb-Sp1 complex formation was abolished by stepwise increase of recombinant Alien $\beta$  protein (Fig. 38).

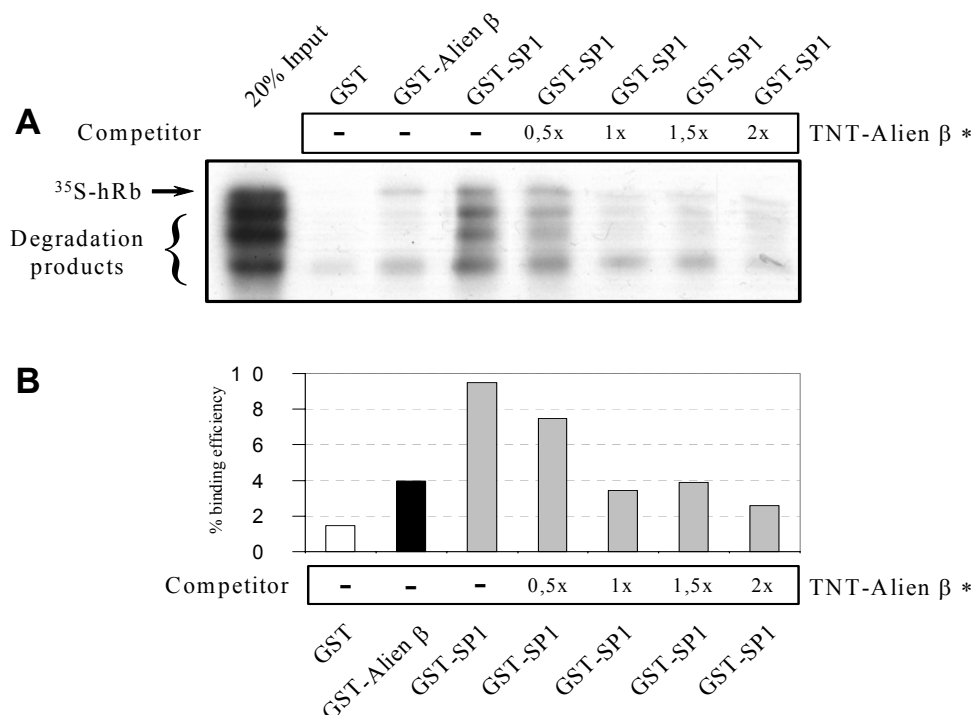


**Fig. 38: Sp1 interacts directly with Rb in GST-pulldown – recombinant Alien $\beta$  interferes with this interaction.** Recombinant Alien $\beta$  was obtained by expressing pGST-hAlien $\beta$  in *E.coli* (BL21-strain), affinity purification using glutathione-sepharose beads and subsequent removal of the GST-tag by thrombin digestion. Thrombin was removed from the supernatant by incubation with p-aminobenzindine-agarose and irreversible inhibition of putative residual thrombin with 8mM PMSF. Purity was controlled by SDS-PAGE and Coomassie staining. As an additional control this extract failed to digest GST-JNK fusion proteins, indicating lack of residual thrombin.  $^{35}$ S-hRb was translated *in vitro* from pCITE-Rb in presence of  $^{35}$ S-Methionine, incubated with bacterially expressed and affinity purified GST (pGST-linker),

GST-Alien $\beta$  (pGST-hAlien $\beta$ ) or GST-Sp1 (pGEX-Sp1-f.l.) in presence of the indicated amounts of recombinant Alien $\beta$  protein as competitor equalized with BSA to 2  $\mu$ g. (A) Proteins copurified during GST-pulldown and 20% of the Rb *in vitro* translation reaction (20% Input) were separated by SDS-PAGE and visualized by autoradiography. (B) Densitometric quantification of the obtained signals determined the binding efficiency (%).

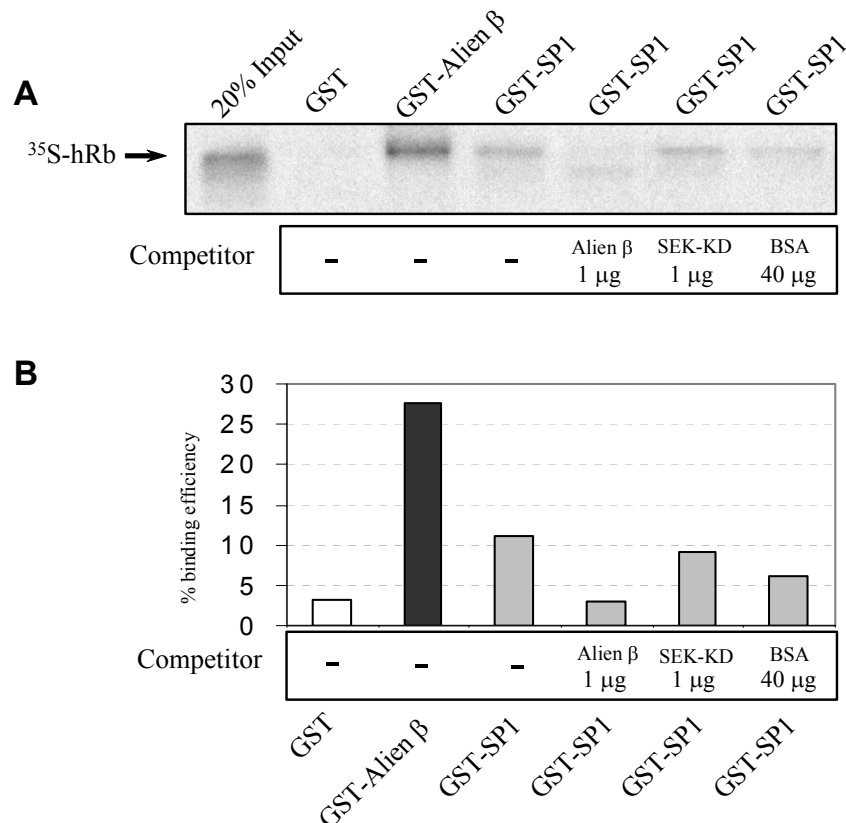
Similar observations were made when increasing amounts of *in vitro* translated Alien $\beta$  were added to the GST-Sp1-Rb binding reaction (Fig. 39). Binding of Rb to GST-SP1 was not altered by addition of unrelated proteins (Fig. 40; recombinant SEK1-*dead kinase* and BSA), indicating specificity of the interference by Alien $\beta$ . Interestingly, in all three GST-pulldown competition experiments slight degradation of *in vitro* translated Rb was observed (Figs. 38, 39, 40). It can be ruled out that this is due to putatively residual thrombin, because there are no predicted thrombin consensus sites in the hRb amino acid sequence (hRb Acc. N $^{\circ}$  AAA69808; query at <http://www.expasy.ch/tools/peptidecutter>)

Thus, the retinoblastoma protein interacts directly with the Sp1 transcription factor. The mechanism of Rb-mediated superactivation of Sp1-driven transcription is interfered by Alien $\beta$  but not by Alien $\alpha$ , putatively by competition for Rb or targeting protein degradation.



**Fig. 39: Sp1 interacts directly with Rb in GST-pulldown – *in vitro*-translated Alien $\beta$  interferes with this interaction.** This GST-pulldown competition experiment was performed analogously to the previously described. As competitor served non-radioactive *in vitro*-translated Alien $\beta$  protein ("\*" - TNT-Alien $\beta$ ). Referring to the amount of competitor "1x" means the amount of translation reaction used per

lane in a standard GST-pulldown experiment (5  $\mu$ l of a 25  $\mu$ l *in vitro* translation reaction (0.5 x, 1.5 x, 2 x refer to this amount)).  $^{35}$ S-hRb was translated *in vitro* from pCITE-Rb in presence of  $^{35}$ S-Methionine and incubated with bacterially expressed and affinity purified GST (pGST-linker), GST-Alien $\beta$  (pGST-hAlien $\beta$ ) or GST-Sp1 (pGEX-Sp1-f.1.) in presence of the indicated amounts of Alien $\beta$  *in vitro* translation reaction filled up with rabbit reticulocyte lysate to equal volumes as competitor. (A) Proteins copurified during GST-pulldown and 20% of the Rb *in vitro* translation reaction (20% Input) were separated by SDS-PAGE and visualized by autoradiography. (B) Densitometric quantification of the obtained signals determined the binding efficiency (%).

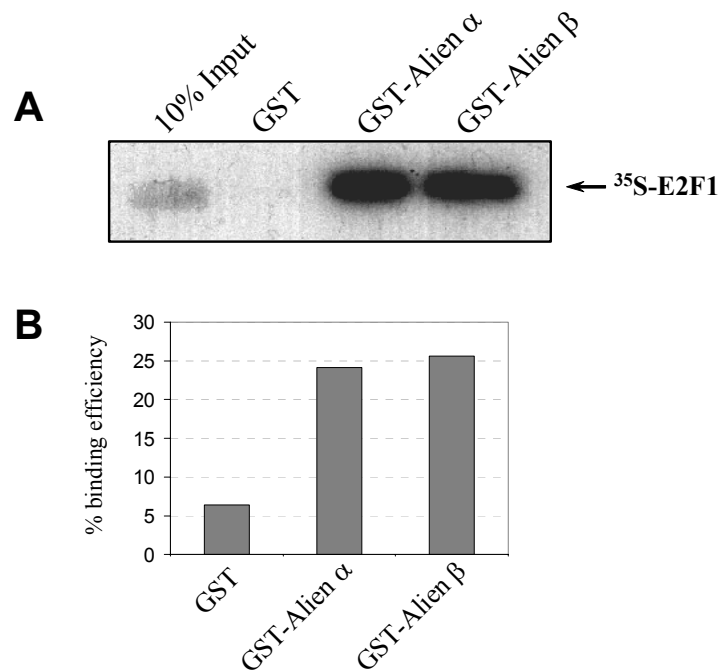


**Fig. 40: Binding of *in vitro*-translated Rb to GST-Sp1 is not altered by addition of unrelated proteins.** The GST-pulldown competition experiment was performed similarly to the previously described ones. The recombinant competitor Alien $\beta$  was prepared as described in the legend of Fig. 38. The recombinant competitor SEK-KD (SEK1-dead kinase mutant) was obtained by the same procedure expressing the plasmid pGEX-SEK1-KD (kindly provided by P. Crespo, IIB, Madrid) in *E. coli*. BSA stands for *bovine serum albumin*.

### 5.3.12 Both, Alien $\alpha$ and Alien $\beta$ interact with *in vitro*-translated E2F1 in GST-pulldown

It is well established that the Rb protein regulates cell cycle progression through direct interaction with the transcription factor E2F (Flemington *et al.*, 1993; Sellers *et al.*, 1995 Harbour and Dean, 2000a). The finding that Alien $\alpha$  and Alien $\beta$  are capable to associate with Rb raises the question, whether Alien proteins may also interact with E2F family transcription factors. For this purpose, binding studies with bacterially expressed

GST-Alien $\alpha$  and GST-Alien $\beta$  and *in vitro*-translated E2F1 protein were performed. Both, GST-Alien $\alpha$  and GST-Alien $\beta$  associate with E2F1 protein *in vitro* with equal binding efficiencies (approx. 25%; Fig. 41) Thus, these findings suggest that Alien $\alpha$  and Alien $\beta$  may form complexes with E2F1 at least *in vitro*.

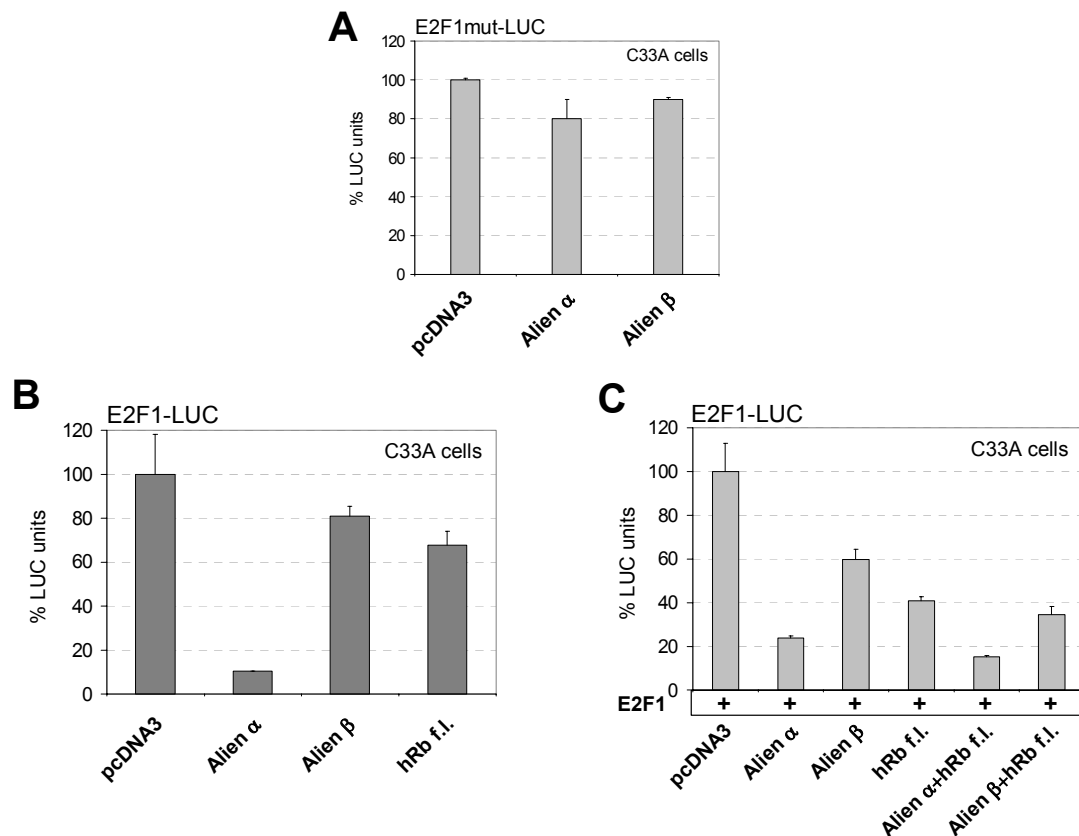


**Fig. 41: Both Alien $\alpha$  and Alien $\beta$  interact with *in vitro* translated E2F1 in GST-pulldown.**  $^{35}\text{S}$ -E2F1 was obtained by *in vitro* translation using the plasmid pGEX-hE2F1-f.l. (M. Campanero) in presence of  $^{35}\text{S}$ -Methionine.  $^{35}\text{S}$ -E2F1 was incubated with bacterially expressed and affinity purified GST (pGST-linker), GST-Alien $\alpha$  (pGST-TRIP15) or GST-Alien $\beta$  (pGST-Alien $\beta$ ). After affinity purification using glutathione-sepharose and extensive washing, a SDS-PAGE was performed with the copurified proteins and 20% of the E2F1 *in vitro* translation reaction (20% Input). Visualization by autoradiography (A) permitted to calculate the % binding efficiency by densitometric quantification of the obtained signals (B).

### 5.3.13 Alien $\alpha$ represses transcriptional activation mediated by an E2F-LUC reporter construct in absence of functional Rb in C33A cells

In order to investigate whether Alien $\alpha$  or Alien $\beta$  may influence E2F mediated transcription *in vivo*, cotransfection experiments were set up using different E2F-LUC reporter constructs in C33A cells. Coexpression of plasmids coding for Alien $\alpha$  and Alien $\beta$  did not significantly influence the basal transcription levels of an E2F-mut-LUC

construct, harboring mutated E2F-DNA binding sequences upstream of the luciferase gene (Fig. 42 A). Interestingly, using the E2F-LUC reporter, *Alien $\alpha$*  strongly repressed E2F mediated transactivation (ten fold), whereas transfection of *Alien $\beta$*  or Rb showed only weak effects on E2F driven transfection under these conditions (Fig. 42 B). This finding is of special significance, because C33A cells lack functional retinoblastoma protein (Scheffner *et al.*, 1991).



**Fig. 42: *Alien $\alpha$*  represses transcriptional activation mediated by an E2F-LUC reporter construct in absence of functional Rb in C33A cells.** (A)  $1.4 \times 10^6$  C33A cells were transiently transfected with 2  $\mu$ g empty vector (pcDNA3) or 2  $\mu$ g of mammalian expression plasmids coding for *Alien $\alpha$*  (pAB-TRIP15) or *Alien $\beta$*  (pcDNA3-CSN2) together with 1.5  $\mu$ g of a reporter construct harboring mutated E2F-binding sites upstream of a luciferase reporter gene. Analogously, panel B and C show the influence of 2  $\mu$ g *Alien $\alpha$* , *Alien $\beta$*  and human full length Rb (hRb f.l.) expression plasmids on 1.5  $\mu$ g of a reporter construct carrying two E2F response elements upstream of the luciferase reporter gene. Each set of C33A cells of the experiment displayed in panel C was cotransfected with 0.5  $\mu$ g of pcDNA-hE2F1 expression plasmid. In each experiment 1  $\mu$ g of a pCMV- $\beta$ -gal cotransfected plasmid served as internal control. The cells were harvested two days after transfection, luciferase activity was measured and normalized to total protein amount and  $\beta$ -gal activity of the cell extracts. Basal luciferase activities of mock transfected cells were set to 100% and the relative promoter activities were derived.

In the presence of exogenously expressed E2F1, Alien $\alpha$  still repressed efficiently E2F-transactivation (~80% repression) on the E2F-LUC reporter construct (Fig. 42 C). Alien $\beta$  had a little stronger effect (40% repression) on E2F-LUC than in absence of exogenously expressed E2F1. Under these conditions cotransfection of Rb diminished E2F transactivation to 40% of its initial level, and transfection of a combination of Alien $\alpha$  with Rb only slightly lowered repression level of Alien $\alpha$  alone. Cotransfection of Alien $\beta$  with Rb had no effect and maintained approximately 60% repression (Fig. 42 C). The fact that most of exogenously expressed Rb is hyperphosphorylated in the cell and interaction with E2F is therefore inactivated (M. Campanero; personal communication) may be one reason why there are no stronger effects of Rb on E2F-LUC reporter constructs observable in this experimental system.

These results are of special interest, because it has been described that certain E2F regulated promoters are kept repressed in the cell even during S-phase, when Rb is not able to repress them due to its phosphorylation status (Koziczak *et al.*, 2000). Alien $\alpha$  could potentially participate in such mechanisms.

Thus, Alien $\alpha$  is capable to repress E2F-mediated transactivation independently of Rb *in vivo*. In contrast to the effect of Alien $\beta$  on Rb-Sp1 superactivation, where Alien $\alpha$  failed to interfere, the repression of E2F-mediated transactivation seems to be mediated mostly by Alien $\alpha$ .

#### **5.3.14 Protein expression of Alien $\alpha$ and Alien $\beta$ during the cell cycle**

Rb and members of the E2F family of transcription factors are described to be key regulators for cell cycle regulation at the G1/S restriction point (Harbour and Dean, 2000a). During cell cycle the phosphorylation status of Rb oscillates between hyper- and hypophosphorylated. Hypophosphorylated Rb binds and represses activation function of the transcription factor E2F, which regulates genes important for S phase progression. At the end of G1 phase Rb gets hyperphosphorylated and loses its ability to bind and repress E2F (Harbour and Dean, 2000b).

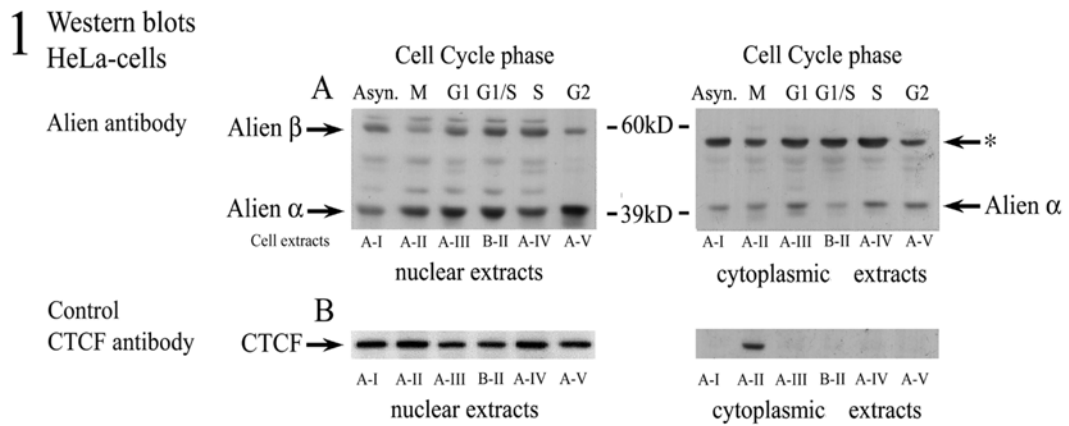
Given the different functions of Rb and E2F during cell cycle (Harbour and Dean, 2000b), interactions of Alien $\alpha$  and Alien $\beta$  with Rb and E2F and other interacting factors may be restricted to certain time points within the cell cycle. Such findings would give important hints to further characterize these interactions. In general, one possibility is regulation of these interactions by posttranslational modification, such as



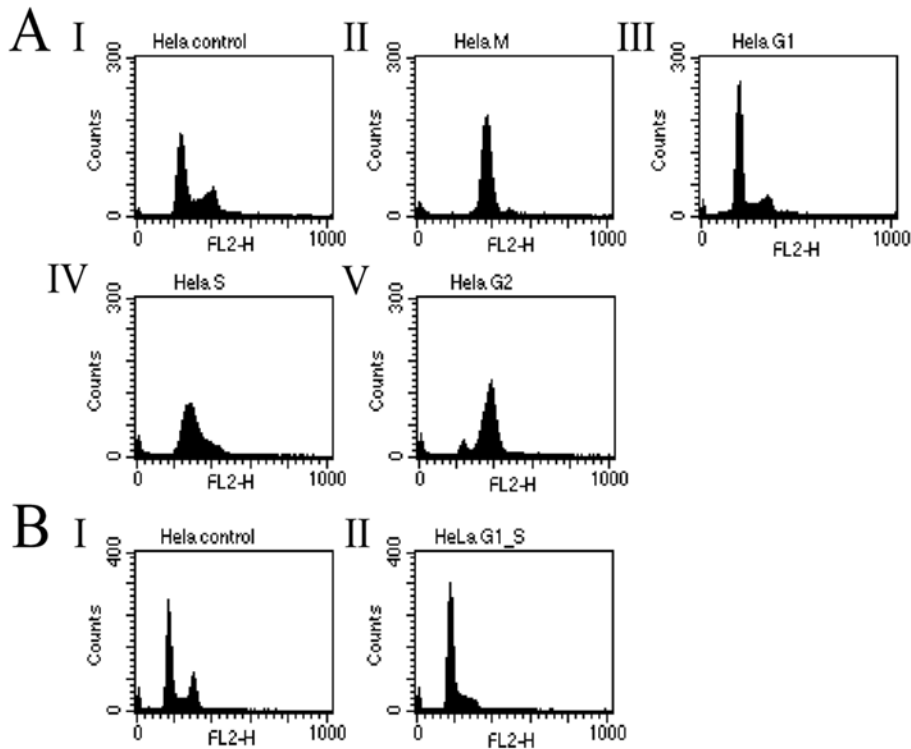
phosphorylation, of one or both interaction partners, as shown for Rb and E2F (Harbour and Dean, 2000a). As a further possibility, a direct protein-protein interaction could be influenced by the availability of the involved proteins. As for example described for Cyclin-Cdk complexes, cell cycle specific degradation of cyclins tightly regulates the activity of Cdk complexes (Lees, 1995). An additional cellular mechanism is regulation of the availability of a transcription factor by changing its localization to another cellular compartment. Multiple examples for this mechanism have been described. For example the transcription factor NF $\kappa$ B is inactivated by retention in the cytoplasm (Karin and Hunter, 1995). In quiescent cells E2F-4 is found in the nucleus as well as in the cytoplasm but relocates almost entirely in the nucleus, where it regulates transcription, when cells reach S-phase (Lindeman *et al.*, 1997). Since e.g. Rb protein expression is detectable throughout cell cycle progression (Furukawa *et al.*, 1990), there was the question, if Alien protein levels may vary. At the same time the subcellular localization of Alien proteins during cell cycle was determined.

In order to answer these questions, asynchronously growing and synchronized HeLa cells were harvested in the different cell cycle states (see material and methods). Cell cycle phases were confirmed by FAC-Scan analyses using duplicated of cell culture dishes (Fig.43-2 A & B). The cells of each cell cycle state were fractionated in nuclear and cytoplasmic extracts and equal amount of protein was applied in Western blots using the anti-Alien peptide antibody (Fig. 43-1 A). As control for purity of the fractions served a Western blot using anti CTCF antibody, a protein found in the nucleus (Fig. 43-1B; Klenova *et al.*, 1993). The anti Alien Western blots revealed the presence of both Alien protein isoforms throughout the cell cycle (Fig. 43-1A). Alien $\alpha$  appeared to be more abundant in the nucleus than in cytoplasm, whereas Alien $\beta$  seemed to be present in similar extent in both cellular compartments. Curiously, the protein band identified as Alien $\beta$  showed higher mobility in cytoplasmic samples, indicating a slightly lower apparent molecular weight of cytoplasmic Alien $\beta$ . Some additional protein bands were detected by the anti-Alien antibody in nuclear and in cytoplasmic samples.

Taken together, these results show that there are no significant changes in protein expression level of either Alien $\alpha$  or Alien $\beta$  during cell cycle in HeLa cells. Furthermore, sub-cellular distribution of Alien $\alpha$  as well as Alien $\beta$  throughout cell cycle does not change either. Hence, protein-protein interactions of Alien protein isoforms with other cellular factors seem not to be regulated by availability of Alien proteins.



**2 Control of Cell Cycle phase (FAC-Scan)**



**Fig. 43: Protein expression of Alien $\alpha$  and Alien $\beta$  during cell cycle.** HeLa cells were synchronized, harvested in different cell cycle states (2A & 2B) and fractionated into nuclear and cytoplasmic extracts as described in material and methods. Panel 1 shows Western blot analyses using anti Alien peptide antibody (1 A) and anti CTCF antiserum (kindly provided by L. Burke, Giessen, Germany) as control for purity of the fractions (1 B). The labels “Cell extracts (AI-AV, BI, BII)” refer to the controls of the cell cycle state of the applied samples obtained by FAC-Scan analyses displayed in panel 2 (A & B). Abbreviations: Asyn = asynchronously growing cells; M = mitosis; G1 = gap1-phase; G1/S = border gap1 to S-phase; S = S-phase; G2 = gap2-phase. Arrows labeled with Alien $\alpha$  and Alien $\beta$  indicate the position of Alien protein isoforms and “\*” marks the position of the lower migrating signal putatively representing cytoplasmic Alien $\beta$ . Molecular weights are indicated in kDa. Note: In mitosis no nuclear membrane exists, thus, cells can not be fractionated, although all samples were processed equally. Therefore, the signal of the nuclear protein CTCF is visible in cytoplasmic samples.

## 5.4 Phosphorylation of Alien $\alpha$ and Alien $\beta$ proteins

A further mechanism of regulation of function of transcription factors and protein-protein interaction takes place through post-translational modification (Hermanson *et al.*, 2002). Among those modifications, one of the most studied is protein phosphorylation (Goldsmith and Cobb, 1994; Hunter, 2000).

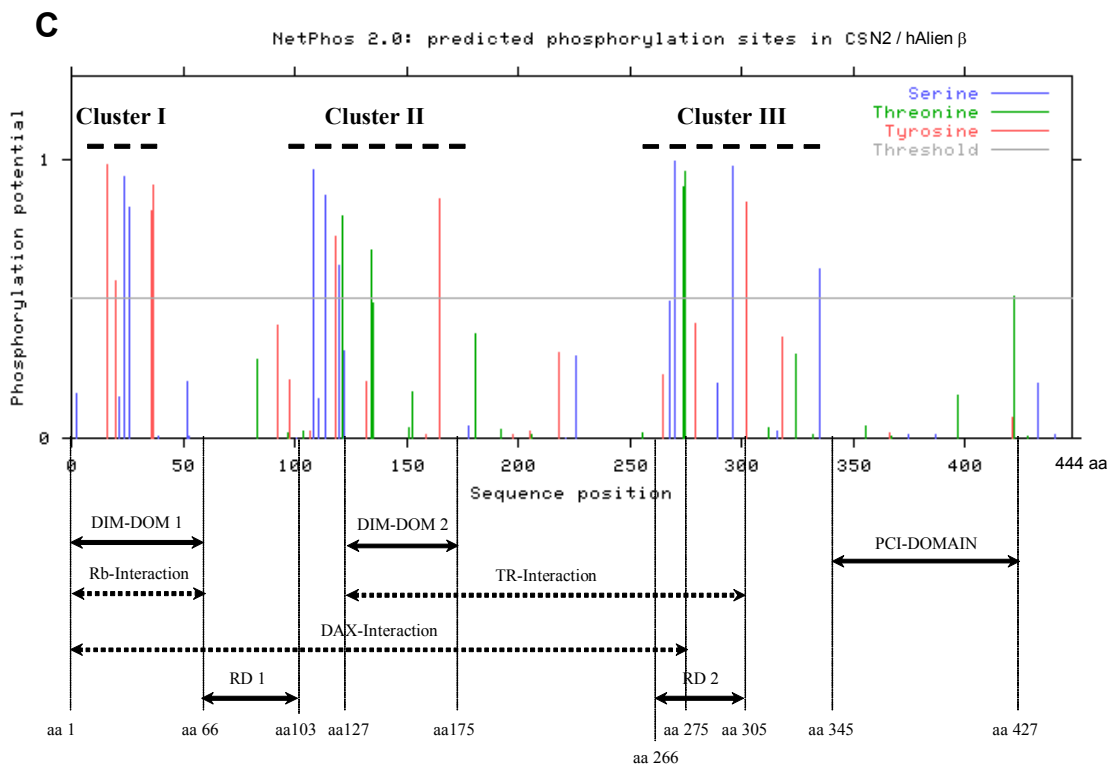
Alien $\beta$  (CSN2) is an integrating subunit of the signalosome (CSN; Naumann *et al.*, 1999). Seeger and coworkers purified this multi protein complex and found that a yet unknown kinase activity co-purifies with the CSN (Seeger *et al.*, 1998). The authors partly characterized this kinase activity and identified c-Jun, I $\kappa$ B and the NF $\kappa$ B precursor p105 as substrates. Furthermore, they detected auto-phosphorylation of the CSN subunits Alien $\beta$  (CSN2) and CSN7, which directly interacts with Alien $\beta$  (Freilich *et al.*, 1999; Kapelari *et al.*, 2000; Naumann *et al.*, 1999). Dephosphorylation of the entire purified CSN-complex *in vitro* by treatment with an unspecific phosphatase resulted in decreased kinase activity towards the above mentioned substrates. In contrast, increased phosphorylation of CSN2 subunit was observed (Kapelari *et al.*, 2000). Resuming these findings dephosphorylation lead to two opposite effects: (i) One part of the CSN associated kinase activity was induced by dephosphorylation, an attribute of kinases induced by phosphatases similar to p34cdc2 (Lew and Kornbluth, 1996). (ii) Another part of this kinase activity was inhibited by dephosphorylation, which is a typical feature of kinases activated by phosphorylation through upstream kinases (Hunter, 2000). Therefore, it may be probable, that the CSN associated kinase activity might be composed of at least two types of kinases. At least one of them phosphorylates Alien $\beta$ /CSN2 (Naumann *et al.*, 1999).

Thus, Alien $\beta$  (CSN2) is phosphorylated in the context of the signalosome. Therefore, it could be deduced, that Alien $\beta$  may be associated with at least one protein kinase. Since it has not been addressed yet whether Alien $\alpha$  may be a phospho-protein, phosphorylation studies with both Alien $\alpha$  and Alien $\beta$  isoforms were carried out.

### 5.4.1 Relationship between domains and functions of hAlien $\beta$ and the prediction of phosphorylation sites

First, database searches using the predicted hAlien $\beta$  amino acid sequence, revealed multiple putative phosphorylation sites ([www.cbs.dtu.dk/services/Netphos](http://www.cbs.dtu.dk/services/Netphos); Netphos 2.0). The search algorithm of this database is built on comparison of consensus

sequences for protein kinases with the query amino acid sequence. As an output, the theoretical phosphorylation probability on serine, threonine and tyrosine residues is provided (Fig. 44). In this scheme the relative location of the putative phosphorylation sites in hAlien $\beta$  are put in relation to known domains and interaction surfaces of Alien $\alpha$  and Alien $\beta$ . Here it should be reminded that the predicted amino acid sequences of Alien $\alpha$  and Alien $\beta$  are identical in the first 305 amino acids, which means that the entire Alien $\alpha$  sequence is included in Alien $\beta$  (PhD thesis of U. Dressel).



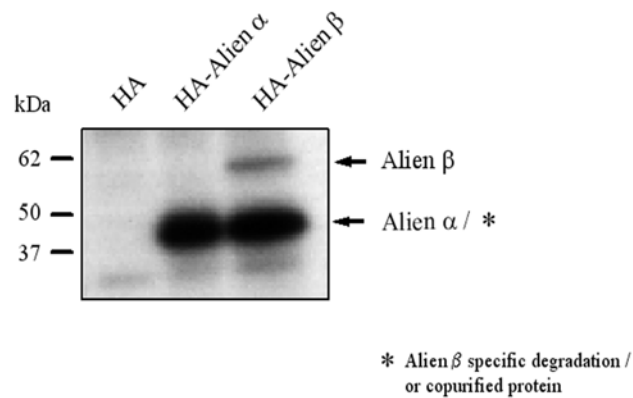
**Fig. 44: Relation of domains and functions of hAlien $\beta$  with prediction of phosphorylation sites and phosphorylation potential.** The amino acid sequence of hAlien $\beta$  / CSN2 (Acc-N $^{\circ}$  AF 084260) was analyzed for putative phosphorylation sites and their calculated phosphorylation probability with Netphos 2.0 ([www.cbs.dtu.dk/services/Netphos](http://www.cbs.dtu.dk/services/Netphos)). The algorithm of Netphos 2.0 is based on similarity to known phosphorylation consensus sites and based on that a probability of 1 at the y-axis means identity to a consensus sequence. Putative serine residues are displayed in blue, threonine residues in green and tyrosine residues in red. The amino acid position within hAlien $\beta$  sequence (aa 1-444) is plotted on the x-axis. Cluster I, II and III indicate accumulation of putative phosphorylation residues. The Netphos prediction is put in relation to known Alien functions and domains. Amino acid positions are indicated. Abbreviations: DIMDOM 1 & 2 = dimerization domain 1 & 2 (Altincicek, unpublished data); PCI-Domain = Proteasome regulatory lid - COP9-signalosome – eukaryotic translation initiation factor 3 – domain (also known as PINT domain; Hofmann and Bucher, 1998); Rb- Interaction = interaction domain with the retinoblastoma protein (this work and Altincicek unpublished data), TR-Interaction = thyroid hormone receptor interaction domain (Dressel *et al.*, 1999); DAX- Interaction = interaction domain with the orphan receptor DAX1 (Altincicek *et al.*, 2000); RD1 & RD2 = repression domain 1 & 2 (Dressel, unpublished data).

The putative phosphorylation sites with the highest phosphorylation probability may roughly be grouped in three clusters (Cluster I, II, and III; Fig. 44). Interestingly, Cluster I locates in the far N-terminus of Alien protein sequence and overlaps with the Rb interaction surface as well as with one of the dimerization domains of Alien proteins (Altincicek and Tenbaum, unpublished data, not shown). Cluster II lays in the second dimerization domain and in the part of Alien proteins responsible for TR and DAX-1 interaction (Altincicek *et al.*, 2000; Dressel *et al.*, 1999, and data not shown). Finally, Cluster III is located approximately between amino acids 266-345 of Alien $\beta$ , mainly overlapping with the TR interaction and the second repression domain (RD2; Dressel *et al.*, 1999 and Dressel unpublished data). Interestingly, no predicted high probability phosphorylation residues are located in the most C-terminal part of Alien $\beta$  – the PCI domain, which is responsible for integration into the signalosome (Freilich *et al.*, 1999). The coincidence of these clusters with functional domains or interaction surfaces of Alien protein isoforms may not necessarily result in influence of phosphorylation of these residues on the overlapping Alien domain, but may give hints for future studies.

#### **5.4.2 Both Alien $\alpha$ and Alien $\beta$ are phospho-proteins *in vivo* in HEK293 cells**

To investigate if such a predicted phosphorylation may occur *in vivo*, it was first important to know if Alien proteins are phosphorylated in HEK293 cells that will be used for these analyses. Therefore, an *in vivo* labeling assay using  $^{32}\text{P}$ -ortho-phosphate in HEK293 cells was carried out. The cells were transfected with expression plasmids coding for hemagglutinine-tag (HA) alone, HA-Alien $\alpha$  or HA-Alien $\beta$ . After the *in vivo* labeling with 2 mCi  $^{32}\text{P}$ -ortho-phosphate per dish HA, HA-Alien $\alpha$  and HA-Alien $\beta$  were immunoprecipitated using HA-antibody, separated by SDS-PAGE and visualized by autoradiography (Fig. 45). This autoradiography shows that HA-Alien $\alpha$  was strongly labeled with  $^{32}\text{P}$ . HA-Alien $\beta$  also was phosphorylated, but presented an intense putative degradation product, interestingly of the same molecular weight as HA-Alien $\alpha$ . If this signal is due to an Alien $\beta$  specific degradation product, it should be generated by a C-terminal proteolysis, because the HA-tag was still present. Such a putative Alien $\beta$  degradation was observed in many of the performed phosphorylation assays and may depend on phosphorylation events. Additionally, it can not be ruled out that the signal could be due to a hypothetical co-purified Alien $\beta$ -interacting phospho-protein.

Thus, Alien $\alpha$  as well as Alien $\beta$  are phospho-proteins *in vivo*.



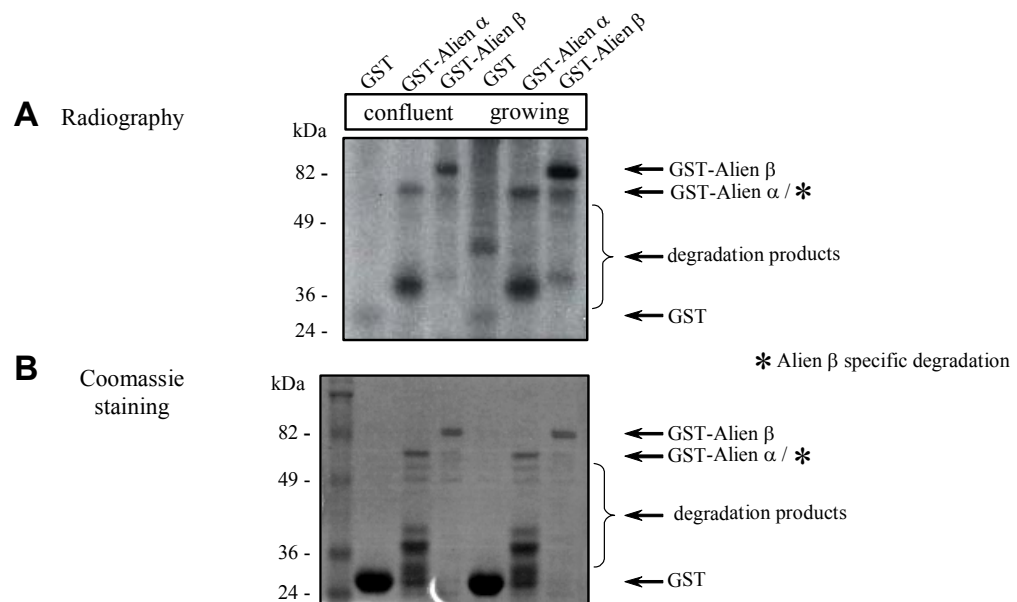
**Fig. 45: Both Alien $\alpha$  and Alien $\beta$  are phospho-proteins *in vivo* in HEK293 cells.** HEK293 cells were transfected with pHA-linker (HA), pHA-Alien $\alpha$  (HA-Alien $\alpha$ ) and pMT2-HA-ch-Alien $\beta$  (HA-Alien $\beta$ ) using the calcium phosphate-method as described in material and methods. 36 h after transfection the medium was withdrawn and the cells were grown for another 12 h in phosphate free medium, followed by incubation with 600 mCi  $^{32}\text{P}$ -ortho-phosphate per dish for 6 h. The cells were lysed and HA-tagged proteins were immunoprecipitated from the supernatant using HA-hybridoma antibody as described in material and methods. Immunoprecipitated proteins were separated by SDS-PAGE and visualized by autoradiography. Arrows indicate the location of HA-tagged Alien $\alpha$  and Alien $\beta$  protein. The molecular weights are indicated in kDa and "\*" marks the putative Alien $\beta$  specific degradation or a hypothetical copurified phosphorylated Alien $\beta$ -interacting protein.

#### 5.4.3 Alien $\alpha$ and Alien $\beta$ bind to a kinase activity present in extracts of HEK293 cells

It was interesting to analyze whether a kinase activity with substrate specificity for Alien $\alpha$  and Alien $\beta$  is also present in cell extracts of HEK293 cells. As the identity of the putative protein kinase activity that is responsible for Alien phosphorylation is unknown, an *in vivo* GST-pulldown experiment combined with an *in vitro* kinase assay was set up.

The assay consisted in incubation of total extracts of exponentially growing or of confluent HEK293 cell cultures with bacterially expressed and purified GST-Alien protein isoforms. After that incubation, the GST fusion proteins were affinity-purified using glutathione-sepharose beads and washed extensively. Next a kinase assay in presence of  $^{32}\text{P}$ - $\gamma$ -ATP was performed with the purified GST-fusion proteins. The obtained radiography and the Coomassie stained SDS-PAGE gel shows that both GST-Alien $\alpha$  and GST-Alien $\beta$ , but not GST alone, were efficiently phosphorylated (Fig. 46 A & B). This means that an unknown kinase activity was co-purified with GST-Alien proteins, but not with GST alone. This kinase activity seems to be more active in growing than in confluent cells comparing GST-Alien $\alpha$  and  $\beta$  protein amount visualized

by Coomassie staining with the intensity of the radioactive labeling of these proteins (Fig. 46). Once more, a GST-Alien $\beta$  specific radioactive degradation product of a similar size than GST-Alien $\alpha$  was detectable. Further degradation may be unspecific and be due to bacterial expression, because they were present in all GST-Alien preparations performed during this work. The outcome of this experiment suggests the existence of a kinase activity in HEK293 cell extracts that binds to Alien $\alpha$  as well as Alien $\beta$ . Furthermore the data indicate that both Alien protein isoforms are substrate of this kinase activity that seems to be more active in growing than in confluent cells.

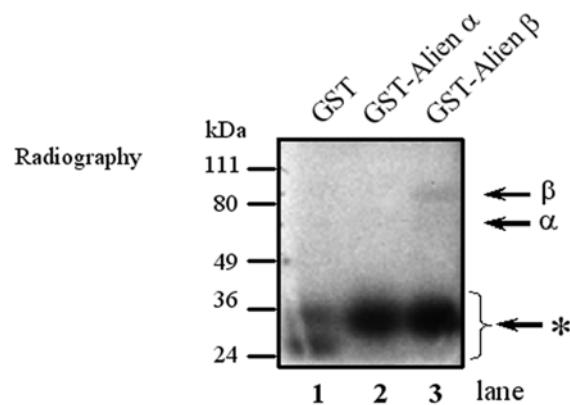


**Fig. 46: Alien $\alpha$  and Alien $\beta$  bind to a kinase activity present in extracts of HEK293 cells. – Both, Alien $\alpha$  and Alien $\beta$  are phosphorylated by this kinase activity, which is more active in growing cells.** HEK293 cells were grown to 60% (growing) and 100% confluence (confluent) before harvesting using trypsin. Cells were counted and equal number of cells was lysed. The obtained total extracts were incubated with 10  $\mu$ g of bacterially expressed and purified GST, 2  $\mu$ g GST-Alien $\alpha$  or 2  $\mu$ g GST-Alien $\beta$  proteins as indicated. After affinity purification with glutathione-sepharose beads, the extensively washed pellets were incubated with  $^{32}$ P- $\gamma$ -ATP in adequate kinase buffer for 30 min at 30°C (see material and methods). The samples were applied to SDS-PAGE, the gel was Coomassie stained (B) and dried. Autoradiography of the gel is shown in panel (A). Molecular weights are indicated in kDa and labeled arrows indicate the location of GST-fusion proteins as well as degradation products (bracket).

#### 5.4.4 Neither recombinant Alien $\alpha$ nor Alien $\beta$ exhibit auto-phosphorylation activity

As a control for the previous assay and to rule out that the obtained results (Fig. 46) are due to auto-phosphorylation events mediated by putative intrinsic kinase activity of GST-Alien $\alpha$  and GST-Alien $\beta$ , a similar experiment was performed without previous incubation of GST-Alien proteins with total cell lysate. This assay proofed ,that bacterially expressed GST-Alien $\alpha$  and GST-Alien $\beta$  alone are not efficiently phosphorylated upon incubation with  $^{32}\text{P}$ - $\gamma$ -ATP (Fig. 47). Unspecific bands may be co-purified bacterial ATP-binding proteins. The weak band detectable in the GST-Alien $\beta$  lane may also be due to unspecific retention of  $^{32}\text{P}$ - $\gamma$ -ATP.

Thus, neither GST-Alien $\alpha$  nor GST-Alien $\beta$  exhibit significant intrinsic kinase activity.



**Fig. 47: Neither recombinant Alien $\alpha$  nor Alien $\beta$  exhibit auto-phosphorylation activity, when incubated with  $^{32}\text{P}$ - $\gamma$ -ATP.** 2  $\mu\text{g}$  of bacterially expressed and purified GST (lane 1), GST-Alien $\alpha$  (lane 2) and GST-Alien $\beta$  (lane 3) were incubated in adequate kinase buffer (see material and methods) supplemented with  $^{32}\text{P}$ - $\gamma$ -ATP for 30 min at 30  $^{\circ}\text{C}$ . Then the proteins were separated by SDS-PAGE and visualized by autoradiography. The molecular weights are indicated in kDa and arrows labeled with  $\alpha$  &  $\beta$  mark the expected position of GST-Alien $\alpha$  and GST-Alien $\beta$ . The arrow labeled with "\*" indicated unspecific signals.

#### 5.4.5 Alien $\beta$ is phosphorylated by at least two kinases of approximately 42 kDa and 35 kDa present in total extracts of HEK293 cells

In order to obtain more information about the putative kinases involved in Alien phosphorylation, *in gel* kinase assays were performed to determine the number and approximate molecular weight of those kinases.

In those experiments, the substrate to be investigated is copolymerized with acrylamide in a denaturing gel and thereby immobilized during the gel run. In these experiments GST-Alien $\beta$  and independently GST was chosen, because, as mentioned before, the Alien $\beta$  amino acid sequence contains the entire Alien $\alpha$  sequence. Total protein extracts



of HEK293 cells treated with different extra cellular stimuli, were separated on such substrate-carrying gels. The entire gels were then submitted to multiple renaturing steps (see material and methods) and finally incubated with  $^{32}\text{P}$ - $\gamma$ -ATP to perform kinase reaction between the substrate and its putative kinase(s). The radioactive signal(s) are expected to appear where kinase(s) and substrate coincide in the gel. Since GST-Alien $\beta$  and GST were immobilized throughout the respective gels, radioactive signals collocate with the kinase proteins separated during electrophoresis. Therefore, the location indicates the approximate molecular weight of these proteins. Appearance of several signals indicates the existence of several specific kinases. It can not be ruled out that the detected kinases are functional breakdown products of kinases of higher molecular weight.

Total extracts of HEK293 cells grown in absence (-FCS), stimulated with fetal calf serum (+FCS) or treated with anisomycin, forskolin or ultraviolet radiation (UV) were applied (Fig. 48 A & C). The autoradiographies displayed represent independent assays and were performed with GST alone as substrate. In both control experiments signals appeared at approximately 100 kDa that are most probably due to auto-phosphorylation by a kinase of this molecular weight. The same unspecific band was detectable in the *in gel* kinase assays set up with GST-Alien $\beta$  as substrate (Fig. 48 B & D). Interestingly, two additional signals at approximately 42 kDa and  $\sim$ 36 kDa are detected when GST-Alien $\beta$  was used as substrate, indicating the existence of at least two kinases phosphorylating Alien $\beta$  under these experimental conditions in HEK293 cells. Curiously, both signals were slightly weaker in cells stimulated with FCS. The  $\sim$ 42 kDa kinase and the lower migrating  $\sim$ 35 kDa kinase seemed not to be significantly induced by the applied stimuli or by addition of FCS (Fig. 48 B & D).

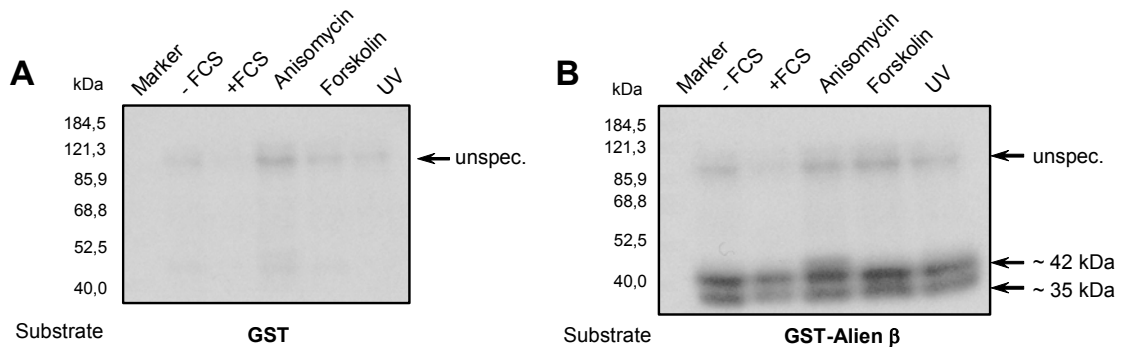
Therefore, it can be deduced that under these conditions at least two different kinases of  $\sim$ 42 kDa and  $\sim$ 35 kDa present in total extracts of HEK293 cells are able to phosphorylate Alien $\beta$ .

#### **5.4.6 Alien $\alpha$ and Alien $\beta$ are not phosphorylated by classic members of the MAPK family of protein kinases**

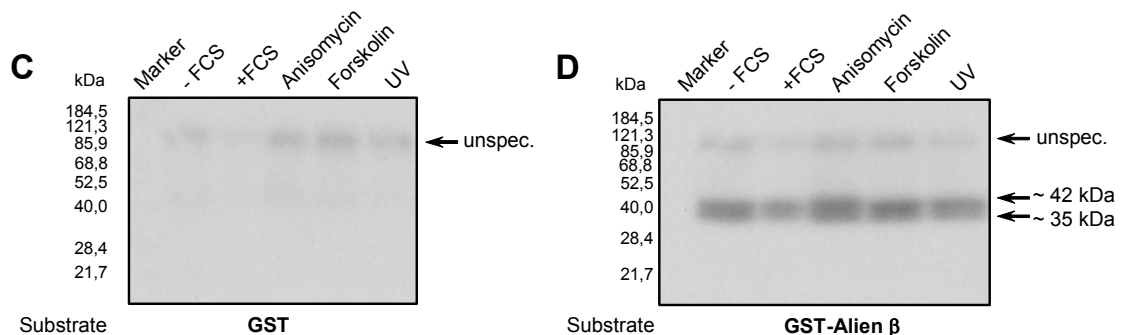
Various hints exist for the possibility of participation of mitogen activated protein kinases (MAPK) in Alien phosphorylation. As already mentioned, the studies performed in the context of the signalosome revealed that the putative CSN-associated kinase activity involved in phosphorylation of Alien $\beta$  (CSN2) might be a kinase

activated by phosphorylation. Additionally, the CSN has been linked to MAPK signaling in various occasions (Spain *et al.*, 1996 Claret *et al.*, 1996 Seeger *et al.*, 1998). Furthermore, this work and the work of others demonstrated that Alien $\alpha$  and Alien $\beta$  are linked to activation of AP1-mediated transcription, as well established for members of the MAPK cascades (Naumann *et al.*, 1999; Hunter, 2000).

**In gel Kinase assay (long run)**



**In gel Kinase assay (short run)**



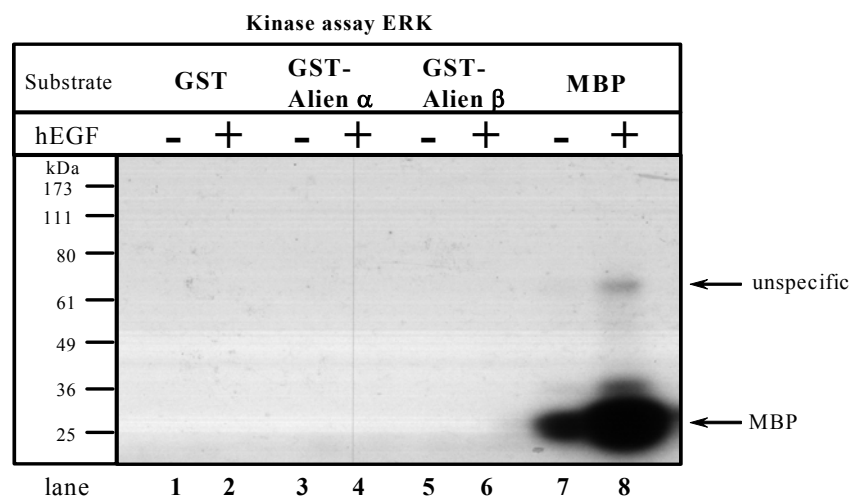
**Fig. 48: Alien $\beta$  is phosphorylated by at least two kinases of approximately 42 kDa and ~35 kDa present in total extracts of HEK293 cells.** *In gel* kinase assays were carried out as described in material and methods using total extracts of HEK293 cells grown for 24h in serum free conditions and stimulated before lysis as following: "-FCS" = no stimulus; "+FCS" = FCS 1:100 for 10 min; "Anisomycin" = 10  $\mu$ g/ml for 30 min; "Forskolin" = 10  $\mu$ M for 30 min; "UV" = 60 J/m<sup>2</sup>; lysis after 15 min. The molecular marker is labeled with "Marker" and is shown in kDa. GST (as control), or GST-Alien $\beta$  indicate the bacterially expressed and purified substrate copolymerized in the respective gels (19  $\mu$ g GST/ml gel; 18  $\mu$ g GST-Alien $\beta$ /ml gel). A, B, C and D represent independent experiments; A & B show the slow migrating molecular range (long run) and C & D the faster migrating one (short run). Arrows indicate the localization of detected signals and their approximate molecular weight in kDa. "unspec." marks an unspecific signal.

Finally, the ~42 kDa kinase, found to phosphorylate Alien $\beta$  in the *in gel* kinase assays, was stimulated by anisomycin to a certain extend and interestingly, isoforms of the MAP-kinases ERK and p38 have molecular weights of approximately 42 kDa (information from Phosphobase; <http://www.cbs.dtu.dk/database/phosphobase>).

Therefore, it should be investigated whether Alien $\alpha$  and Alien $\beta$  are substrates of mitogen activated kinases.

#### 5.4.7 Alien $\alpha$ and Alien $\beta$ are not phosphorylated by ERK isoforms *in vitro*

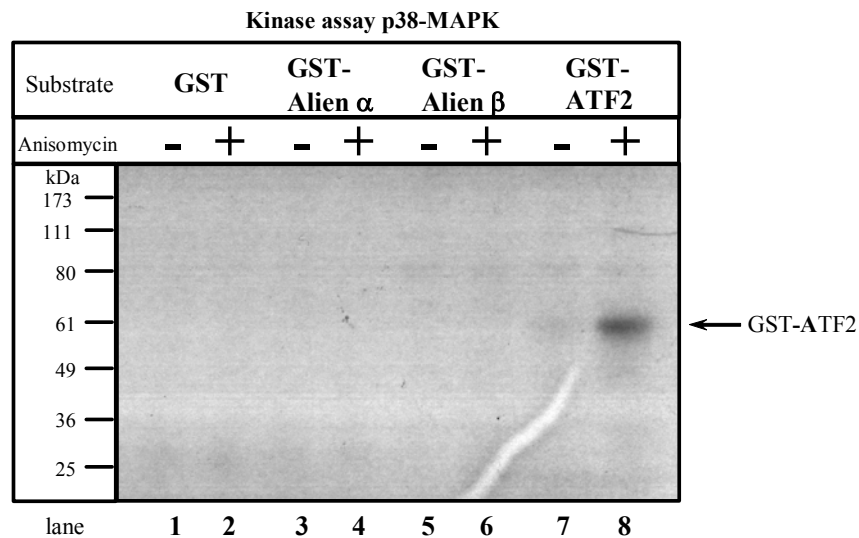
To check whether Alien $\alpha$  and Alien $\beta$  may be substrates for extra cellular regulated kinase isoforms 1 and 2 (ERK1 and ERK2), an *in vitro* kinase assay using immunoprecipitated ERK isoforms was set up. The anti-ERK antibody applied here recognizes both mentioned ERK isoforms. The experiment was performed as described in material and methods. As positive control the known ERK substrate MBP (myelin basic protein) and as a negative control GST alone was used. Human epidermal growth factor (hEGF) was chosen for ERK stimulation. ERK isoforms were not able to phosphorylate neither GST-Alien $\alpha$  nor GST-Alien $\beta$  (Fig. 49; lane 3-6) but as a positive control MBP (lane 7 & 8) was efficiently modified upon induction by hEGF.



**Fig. 49: Alien $\alpha$  and Alien $\beta$  are not phosphorylated by ERK isoforms *in vitro*.** *In vitro* kinase assays were performed as specified in more detail in material and methods. HEK293 cells were grown for 24 h under serum free conditions and stimulated or not with 10 ng/ml human epidermal growth factor (hEGF) for 5 min as indicated by "-" and "+". After cell lysis, ERK protein isoforms were immunoprecipitated from the supernatants using an anti-ERK antibody (Sta. Cruz). The immunoprecipitated pellets were incubated with the indicated substrates (0.5  $\mu$ g of each GST; GST-Alien $\alpha$ , GST-Alien $\beta$ , MBP = myelin basic protein) in adequate kinase buffer and in presence of  $^{32}$ P- $\gamma$ -ATP for 30 min at 30°C. The samples were subjected to SDS-PAGE and visualized by autoradiography. Molecular weights are indicated in kDa, lanes are numbered (1-8) and arrows mark the position of MBP or an unspecific signal in the gel.

#### 5.4.8 Alien $\alpha$ and Alien $\beta$ are not substrate of p38-MAP-kinases *in vitro*

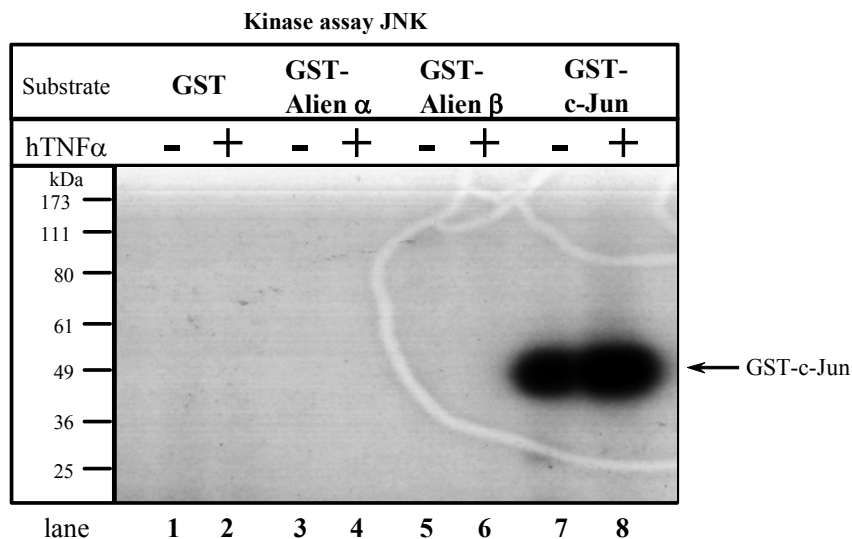
A similar experiment was performed using immunoprecipitated p38-MAPK stimulated or not with anisomycin. GST-ATF2 (Fig. 50; lane 7 & 8) but not GST, GST-Alien $\alpha$  and GST-Alien $\beta$  (lane 1-6) is phosphorylated upon anisomycin stimulation of p38-MAPK *in vitro*.



**Fig. 50: Alien $\alpha$  and Alien $\beta$  are not substrate of p38-MAPK isoforms *in vitro*.** The experiment was performed similar to the ERK *in vitro* kinase assay (Fig. 49). Bacterially expressed and purified GST-ATF2 served as p38-MAPK specific substrate. The cells were stimulated or not with 10  $\mu$ g/ml anisomycin for 10 min. An anti-p38-MAPK antibody (Sta. Cruz) that recognizes all of the p38-MAPK isoforms was used. Molecular weights are indicated in kDa, lanes are numbered (1-8) and arrows mark the position of GST-ATF2 in the gel.

#### 5.4.9 Alien $\alpha$ and Alien $\beta$ are not phosphorylated by JNK *in vitro*

In addition, it was investigated whether Alien protein isoforms may be substrate of the Jun-N-terminal kinase (JNK), the main responsible for AP1 transcriptional activation (Karin and Hunter, 1995). Immunoprecipitated JNK efficiently phosphorylated recombinant GST-c-Jun (lane 7 & 8) but none of the GST-Alien substrates (lane 3-6) after stimulation by human tumor necrosis factor alpha (hTNF $\alpha$ ; Fig. 51). Thus, neither Alien $\alpha$  nor Alien $\beta$  are substrate of the tested mitogen activated protein kinases *in vitro*.

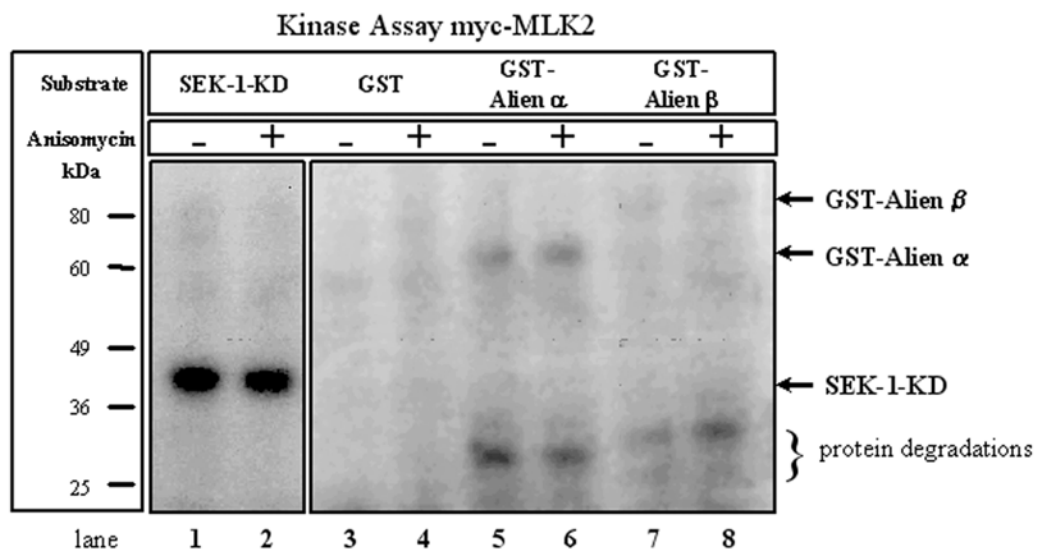


**Fig. 51: Alien $\alpha$  and Alien $\beta$  are not phosphorylated by JNK *in vitro*.** The experiment was performed similar to the ERK *in vitro* kinase assay (Fig. 49). Bacterially expressed and purified GST-c-Jun (C-terminal deletion mutant) served as JNK specific substrate. The cells were stimulated or not with 10 ng/ml human tumor necrosis factor alpha (hTNF $\alpha$ ) for 7 min. An anti-JNK antibody (Sta. Cruz) was used. Molecular weights are indicated in kDa, lanes are numbered (1-8) and arrows mark the position of GST-c-Jun in the gel.

#### 5.4.10 Alien $\alpha$ but not Alien $\beta$ is substrate of MLK2 *in vitro*

A yeast-two-hybrid screen performed by M. Eckey in the working group of A. Baniahmad identified a MAPKKK, member of the mixed-lineage kinase family, MLK2 as an Alien $\alpha$  interacting protein (unpublished data). Since a kinase requires the interaction with its substrate for kinase reaction, binding of at least Alien $\alpha$  to MLK2 may result in Alien phosphorylation. Thus, it was interesting to study, whether Alien $\alpha$  and Alien $\beta$  may be a substrate for MLK2. Myc-tagged MLK2 was transfected into HEK293 cells and stimulated or not with anisomycin, known to activate MLK2 (Cuenda and Dorow, 1998). The stimulation of MLK2 with anisomycin was applied to fully induce MLK2, although overexpressed MLK2 is considered constitutively active (Nagata *et al.*, 1998). As natural substrate a *dead kinase* mutant of the MLK2 downstream activated kinases SEK-1 (SEK1-KD; Hirai *et al.*, 1998) that lacks auto-

phosphorylation activity was used. Myc-MLK2 immunoprecipitated using an anti myc-tag antibody, was able to phosphorylate the known substrate SEK1-KD (Fig. 52; lane 1 & 2). Stimulation by anisomycin did not further induce overexpressed myc-MLK2 for the above mentioned reasons. GST alone was not substrate of MLK2 (Fig. 52; lane 3 & 4). Astonishingly, usage of GST-Alien $\alpha$  as substrate resulted in phosphorylation by MLK2 (lane 5 & 6). GST-Alien $\beta$  displayed only very weak radioactive signal upon kinase reaction with MLK2, suggesting that, in contrast to GST-Alien $\alpha$ , GST-Alien $\beta$  is at the best a very bad substrate for MLK2 under the applied conditions (Fig. 52; lane 7 & 8). Thus, Alien $\alpha$  interacts with the mixed-lineage kinase 2 (MLK2) in yeast, as discovered by M. Eckey, and Alien $\alpha$  seems to be phosphorylated by MLK2 *in vitro* and in contrast to Alien $\beta$



**Fig. 52: Alien $\alpha$  but not Alien $\beta$  is substrate of MLK2 *in vitro*.** This *in vitro* kinase assay was carried out as described in detail in material and methods. Myc-tagged MLK2 was immunoprecipitated using 9E10-myc-hybridoma antibody from HEK293 cells transfected with p-myc-MLK2 (D. Dorrow) stimulated or not with 10  $\mu$ g/ml anisomycin for 10 min. The immunoprecipitated pellets were incubated with the indicated substrates and  $^{32}$ P- $\gamma$ -ATP in a MLK2 specific kinase buffer for 30 min at 30°C. As MLK2 specific substrate served recombinant SEK1-KD, an auto-phosphorylation deficient mutant of the SEK1 kinase (Hirai *et al.*, 1997). The samples were separated by SDS-PAGE and visualized by autoradiography. Molecular weights are indicated in kDa, lanes are numbered (1-8) and arrows mark the position of GST-Alien protein isoforms, SEK-KD or unspecific signals resulting from protein degradations.

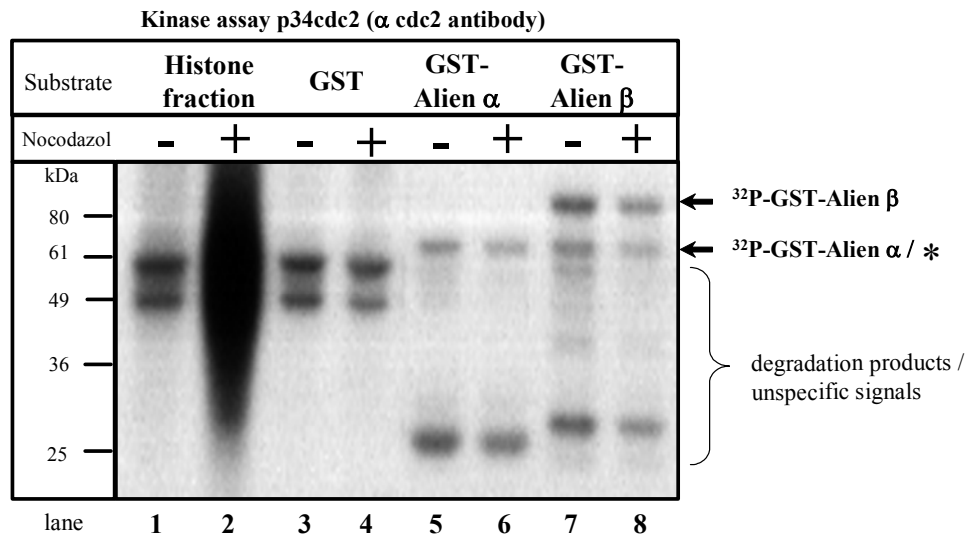
#### 5.4.11 Alien $\alpha$ and Alien $\beta$ are substrates for p34cdc2

Another internet data base compares query protein sequences with known consensus sequences of several kinases (Phosphobase; <http://www.cbs.dtu.dk/database/phosphobase/predict/predform.html>). Using the hAlien $\beta$  amino acid sequence (Acc. N° AF084260) as a query, revealed among others a putative phosphorylation site for the cell cycle kinase p34cdc2 at Serine 270 of both Alien $\alpha$  and Alien $\beta$ . The protein kinase p34cdc2 forms together with the regulatory subunits Cyclin A or B the Cdk1-complex, also known as MPF (mitosis promoting factor; Abrieu *et al.*, 2001).

The signalosome was linked in some cases to cell cycle regulation (Yang *et al.*, 2002). Alien beta (CSN2) was shown to directly interact with CSN6 (hVIP; Kapelari *et al.*, 2000). Expression of hVIP antisense RNA in mammalian cells arrests cells in G2/M-phase through inhibition of p34cdc2 (Mahalingam *et al.*, 1998). Furthermore, the Alien interacting proteins Rb and E2F are found in complexes together with p34cdc2 (Arroyo *et al.*, 1993; Dou *et al.*, 1992; van Wijnen *et al.*, 1996; Hayashi and Yamaguchi, 1999). Additionally, Rb is substrate of p34cdc2 (Taieb *et al.*, 1998). This kinase is activated in late G2-phase by the cdc25 phosphatase. Subsequently p34cdc2 complexes with Cyclin A or B and drives the cell into mitosis (Lew and Kornbluth, 1996). As another hint, the phosphorylation of Alien $\beta$  by the CSN-associated kinase activity is induced, as well as p34cdc2 by dephosphorylation (Kapelari *et al.*, 2000). Furthermore, the *in gel* kinase assays revealed a ~35kDa protein as a possible kinase able to phosphorylate at least Alien $\beta$  (Fig. 48). Interestingly, p34cdc2 has a molecular weight of 34kDa. Finally, the kinase activity phosphorylating Alien $\alpha$  and Alien $\beta$  in the GST-pulldown-kinase assay in HEK293 cell extracts was more active in dividing than in confluent cells (Fig. 46). Since, p34cdc2 only is active during mitosis; this may putatively have contributed to the higher phosphorylation rate observed. For these reasons, p34cdc2 may be a candidate kinase for Alien phosphorylation.

To investigate, whether Alien protein isoforms may be a substrate for p34cdc2, an *in vitro* kinase assay using a specific anti p34cdc2 antibody for immunoprecipitation of the kinase was done. As known substrate for p34cdc2 kinase reaction served a partly purified histone fraction (Sigma). Some histones harbor multiple p34cdc2 phosphorylation sites. Not as a stimulus, but to enrich active p34cdc2-cyclin kinase complexes, the cells were treated or not with nocodazol, arresting cells in late mitosis (Krek and DeCaprio, 1995). Strong phosphorylation of the histone fraction by p34cdc2 was observable upon nocodazol treatment (Fig. 53; lane 1 & 2). GST alone was no

substrate for p34cdc2 (lane 3 & 4). Interestingly, lane 4-8 revealed that both, GST-Alien $\alpha$  and GST-Alien $\beta$  are efficiently phosphorylated by p34cdc2 *in vitro*. Curiously, slightly lower phosphorylation rate was obtained applying nocodazol. Some unspecific signals are detected in lane 3 and 4.

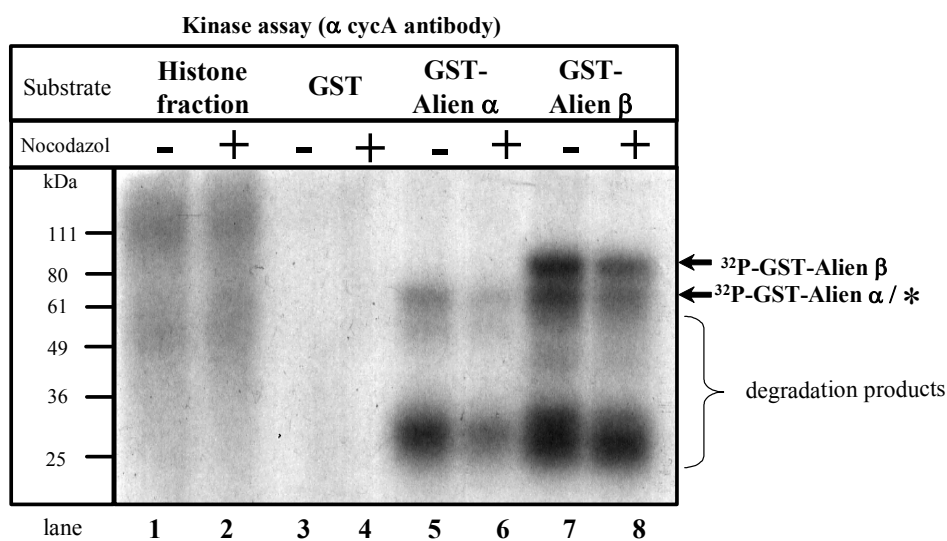


\* Alien  $\beta$  specific degradation

**Fig. 53: Alien $\alpha$  and Alien $\beta$  are substrates for p34cdc2 *in vitro*.** This assay was performed analogously to the previously described *in vitro* kinase assays (also see material and methods for details). HeLa cells were arrested or not by 16 h nocodazol treatment (50 ng/ml). The cells were lysed and p34cdc2 was immunoprecipitated using an anti-cdc2 antiserum (kindly provided by C. Cales, IIB, Madrid) from the supernatants. The immunoprecipitated pellets were incubated with the indicated purified substrates. As p34cdc2 specific substrate served a partially purified histone fraction (Sigma). The positions of GST-Alien $\alpha$ , GST-Alien $\beta$ , the Alien $\beta$  specific degradation ("\*") and unspecific signals are indicated in the figure. Molecular weights are displayed in kDa and the lanes are numbered (1-8).

To verify these findings similar assays were done using anti-Cyclin A antibodies to purify the p34cdc2/cyclin complexes. GST-Alien $\alpha$  as well as GST-Alien $\beta$  was phosphorylated by the kinase complexed with Cyclin A (Fig. 54). No induction of histone phosphorylation was observed and once more, lower phosphorylation of both GST-Alien isoforms occurred in nocodazol-treated samples.



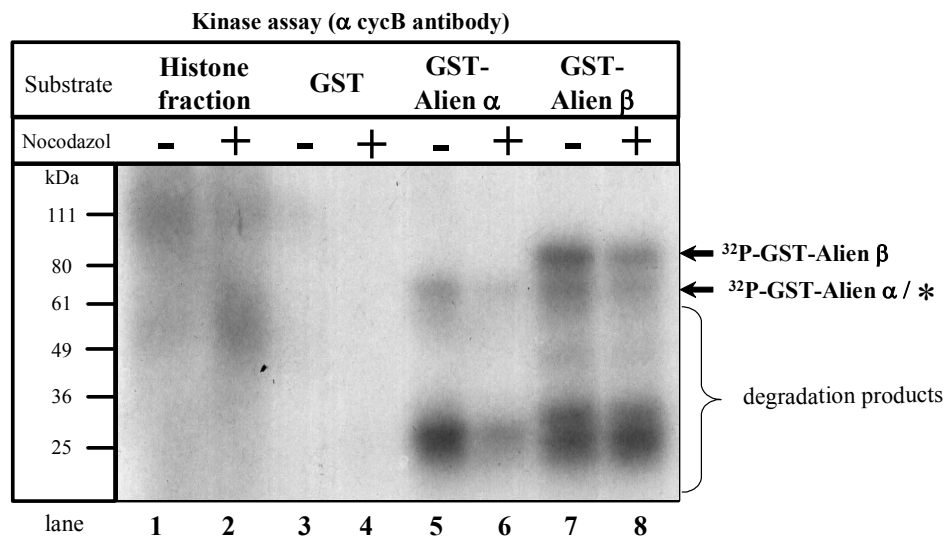


\* Alien  $\beta$  specific degradation

**Fig. 54: Alien $\alpha$  and Alien $\beta$  are substrates for a kinase complexed with Cyclin A *in vitro*.** This assay was performed analogously to the previously described *in vitro* kinase assays (also see material and methods for details). HeLa cells were arrested or not by 16 h nocodazol treatment (50 ng/ml). The cells were lysed and Cyclin A was immunoprecipitated using an anti-Cyclin A antiserum (kindly provided by C. Cales, IIB, Madrid, Spain) from the supernatants. The immunoprecipitated pellets were incubated with the indicated purified substrates. As control substrate served a partially purified histone fraction (Sigma). The positions of GST-Alien $\alpha$ , GST-Alien $\beta$ , the Alien $\beta$  specific degradation ("\*") and unspecific signals of degradation products are indicated in the figure. Molecular weights are displayed in kDa and the lanes are numbered (1-8).

Finally, applying an anti-Cyclin B antibody for immunoprecipitation resulted in similar results (Fig. 55). In contrast to the experiment using the anti-Cyclin A antibody, a weak but detectable induction in phosphorylation of histone fraction was present (lane 1 & 2). Phosphorylation of Alien $\alpha$  and Alien $\beta$  was lower in presence of nocodazol in this assay, too (lane 5-8).

Thus, both Alien $\alpha$  and Alien $\beta$  are substrates for p34cdc2 *in vitro*. Furthermore, both Alien protein isoforms are phosphorylated by kinases associated with Cyclin A and Cyclin B. It has been shown that p34cdc2 associates with both types of cyclins (Lew and Kornbluth, 1996).



\* Alien  $\beta$  specific degradation

**Fig. 55: Alien $\alpha$  and Alien $\beta$  are substrates for a kinase complexed with Cyclin B *in vitro*.** This assay was performed analogously to the previously described *in vitro* kinase assays (also see material and methods for details). HeLa cells were arrested or not by 16 h nocodazol treatment (50 ng/ml). The cells were lysed and Cyclin B was immunoprecipitated using an anti-Cyclin B antiserum (kindly provided by C. Cales, IIB, Madrid, Spain) from the supernatants. The immunoprecipitated pellets were incubated with the indicated purified substrates. As substrate for positive control served a partially purified histone fraction (Sigma). The positions of GST-Alien $\alpha$ , GST-Alien $\beta$ , the Alien $\beta$  specific degradation ("\*") and unspecific signals of degradation products are indicated in the figure. Molecular weights are displayed in kDa and the lanes are numbered (1-8).

### 5.5 Summary of the results comparing features of Alien $\alpha$ and Alien $\beta$

Features	Alien $\alpha$	Alien $\beta$
Gene expression regulated by T3	+	+
Silencing	+ <sup>1</sup>	+
Interaction with TR ( <i>in vitro</i> )	+ <sup>1</sup>	+
Stimulation of AP1-mediated transcription	+	+ <sup>2</sup>
Interaction with Rb ( <i>in vitro</i> )	+	+
Interaction with Rb (in yeast)	+	+
Interaction with E2F1 ( <i>in vitro</i> )	+	+
Phosphorylation ( <i>in vivo</i> )	+	+
Binding to an unknown kinase	+	+
Phosphorylation by MAPK (JNK, ERK, p38)	-	-
Phosphorylation by p34cdc2	+	+
Phosphorylation by MLK2	+	-
Interference with Rb-Sp1-pathway	-	+
Repression of E2F-mediated transcription	+	-

**Tab. 1: Summary of the results comparing features of Alien $\alpha$  and Alien $\beta$ .** The investigated features are listed in the left column. "+" means positive for the indicated feature; "-" means negative. <sup>1</sup> = previously described in Dressel *et al.*, 1999. <sup>2</sup> = previously shown by Naumann *et al.*, 1999. The grey part of the table indicates common features of Alien $\alpha$  and Alien $\beta$ , the white one shows diverging functions.

## 6. Discussion:

### 6.1 Studies on Alien mRNA and protein expression suggest tissue-specific functions and post-transcriptional regulatory mechanisms

#### 6.1.1 The expression of alien mRNAs varies within different rat tissues

Alien mRNA analyses revealed differences in the ratio of the two major alien RNA signals. In most rat tissues the signal of the 2 kb messenger is stronger than that of the 4 kb mRNA. Surprisingly, this ratio is changed in samples of the rat CNS. The amount of the 4 kb messenger was clearly higher than the 2 kb signal in cerebrum and cerebellum and the ratio is nearly equal in rat spinal cord. Although there are hints for at least two alien genes in rodents (Tenbaum *et al.*, submitted), it can not be deduced that each putative rodent alien gene codes for either one or the other alien messenger.

On the one hand, changes in the ratios of the different alien mRNAs may putatively be due to differential regulation of expression of alien mRNA species. This would suggest transcription from different genes with distinct promoter regions.

On the other hand, the observed variations may be due to tissue-specific changes in mRNA stability. Supporting this, tissue-specific factors involved in RNA stabilization mechanisms are described (Staton *et al.*, 2000 Rodriguez-Pascual *et al.*, 2000 Guhaniyogi and Brewer, 2001). In line with that, mRNA sequence of hAlien $\alpha$  (Acc. N $^{\circ}$ : AF120268) and hAlien $\beta$  (CSN2; Acc. N $^{\circ}$ : AF084260; not shown) contain various AUUUA-motifs (AU-rich elements; ARE's; (Fig. 56).

These AU-motifs are found in mRNAs that encode proteins produced only in short bursts in response to internal or external stimuli. Messenger RNAs of early response genes, transiently expressed proto-oncogenes and nuclear transcription factors possess those motifs and are characterized by short half-lives (Staton *et al.*, 2000). AU-rich elements are recognized by specific trans-acting mRNA-binding factors that may stabilize the bound mRNA or mediate mRNA degradation by different, seemingly redundant pathways that depend on cellular conditions. In line with that, the levels of alien RNA were induced by addition of cycloheximide, a general inhibitor of protein synthesis. This is characteristic for mRNAs regulated by RNA-binding proteins (Guhaniyogi and Brewer, 2001; Staton *et al.*, 2000). Thereby, RNA-degrading proteins may be absent due to inhibition of their translation and consequently, the levels of the regulated mRNA would augment.

Thus, such mechanisms may hypothetically stabilize or destabilize alien mRNAs depending on tissue-specific trans-acting RNA-binding factors.

### **hAlien $\alpha$ mRNA (AF120268)**

```

5' - AUG GAG GAU GAU UUC AUG UGC GAU GAU GAG GAG GAC UAC GAC CUG GAA UAC UCU GAA GAU AGU
AAC UCC GAG CCA AAU GUG GAU UUG GAA AAU CAG UAC UAU AAU UCC AAA GCA UUA AAA GAA GAU GAC
CCA AAA GCG GCA UUA AGC AGU UUC CAA AAG GUU UUG GAA CUU GAA GGU GAA AAA GGA GAA UGG GGA
UUU AAA GCA CUG AAA CAA AUG AUU AAG AUU AAC UUC AAG UUG ACA AAC UUU CCA GAA AUG AUG AAU
AGA UAU AAG CAG CUA UUG ACC UAU AUU CGG AGU GCA GUC ACA AGA AAU UAU UCU GAA AAA UCC AUU
AAU UCU AUU CUU GAU UAU AUC UCU ACU UCU AAA CAG AUG GAU UUA CUG CAG GAA UUC UAU GAA ACA
ACA CUG GAA GCU UUG AAA GAU GCU AAG AAU GAU AGA CUG UGG UUU AAG ACA AAC ACA AAG CUU GGA
AAA UUA UAU UUA GAA CGA GAG GAA UAU GGA AAG CUU CAA AAA AUU UUA CGC CAG UUA CAU CAG UCG
UGC CAG ACU GAU GAU GGA GAA GAU GAU CUG AAA AAA GGU ACA CAG UUA UUA GAA AUA UAU GCU UUG
GAA AUU CAA AUG UAC ACA GCA CAG AAA AAU AAC AAA AAA CUU AAA GCA CUC UAU GAA CAG UCA CUU
CAC AUC AAG UCU GCC AUC CCU CAU CCA CUG AUU AUG GGA GUU AUC AGA GAA UGU GGU AAA AUG
CAC UUG AGG GAA GGU GAA UUU GAA AAG GCA CAC ACU GAU UUU UUU GAA GCC UUC AAG AAU UAU GAU
GAA UCU GGA AGU CCA AGA CGA ACC ACU UGC UUA AAA UAU UUG GUC UUA GCA AAU AUG CUU AUG AAA
UCG GGA AUA AAU CCA UUU GAC UCA CAG GAG GCC AAG CCG UAC AAA AUG AUC CAG AAA UUU UAG
CAAUGACGAUUUAAGAGUUAAGGAGUUAAAACAUAAGAUUAGCUAGUAGUGGAGAGCUUGCUGGUGCAGAGCAUAUUGGAUAAACUA
UGAUCCUUUAUAAGAGAACACAUAUGAAGAGCUUUUUGCAGAACAUCAGAACAACAAGUCUUUAUUUUAAUUAAGCCUUACACAAGA
AUACAUAUUUUUUUUUUUUAUUUUAAGGAGUUAAAACAUAAGAUUAGCUAGUAGUGGAGAGCUUGCUGGUGCAGAGCAUAUUGGAUAAACUA
UUCAUGGCCCAAUUGAUCAAGUCAACCAACUCCUUGAACUGGAUCAUCAGAAGAGGGGUGGUGCACGAUUAUCUGCACUAGAUAAUUG
GACCAACCAACUAAAUCUCUCAACCAGGCUGUAGUCAGUAAAACUGGCUUAAACAGAGAACAAGCUUUUACAGACGUCUUAAGGCCAACA
GUGCAGAGAUGUAAUCCUUAUAAAGAACUGGGAUUGGCAAAACUACUGCUGGUUGAUGUGUCCUGAAAAUUAUUGGAGUUAUGGCAGAA
GUGCUUUUUUGAUCACACUGGUUUUGUUUUnCUGCUGCAUUUAUCCCAAGAAAACAGCUUUAUUCUCCAGAAAGAAAACCAAAUACC
AUGGGUUUUUUGCUGUAUUUGACAUCUUGCCCUAAACGUACAACAUCUAUGUAAUUUUGUCAUGGGCAACAUGGACCAAGAGAGAAGAUUU
UUCGUUCAAUUUAUUUAUACACUGACACGCUACUGUUGGUUAUUUUUAACAUGUUUUUCCUGCAGAAAUUCUCUCACAAAUAACC
UGC AAUAACUUGAAAUGCAUACCCUUUUUGAACACUUCUUCUUCUUGUAUAAAUAUUUUUUGUUGUUGCAUUUUUGCAAAAUGUCAAU
UCUCUAAAAAUGUGUCCGUAAUAUUUCUGUAACCUGCAGUGUAGUAAAGGUUUAGACGAAACCCCAUAAUUUAUGUGGCAUACUGUCACU
UAGGUUUCAAGCAGCAAAAUAACCGUGCAGCUCAGAAAAAUAUUUUUUUUUUUUUUUUUUUUUUUUUUUUUUUUUUUUUUUUUUUUUUUUUU
AAAAAAAAA-3'

```

**Fig. 56:** The Alien $\alpha$  mRNA sequence contains various A/U-rich motifs (ARE's) associated with RNA destabilization. The mRNA sequence of hAlien $\alpha$  (Acc N°.AF120268) and is shown. The start and stop codon is boxed in grey and coding nucleotide triplets are separated. The 5' and the 3' end of the mRNA is indicated and the 3'-untranslated regions is underlined. ARE's are boxed in black with white letters.

On the protein level there are also detectable differences. Interestingly, the protein amount and ratio of Alien $\alpha$  and Alien $\beta$  isoforms varies among the different rat tissues as observed here. Organs like liver, skeletal muscle, heart, thymus and white and grey adipose tissues showed apparently absence of Alien $\beta$  expression. On the contrary Alien $\alpha$  was nearly undetectable in rat spleen, lung, uterus, testis, cerebellum and the spinal cord. Surprisingly, rat thyroid glands exhibit extremely low amounts of both Alien $\alpha$  and Alien $\beta$ . Since most of the investigated tissues express alien mRNA to certain extent, the observed differences in Alien protein expression indicate putative tissue-specific post-translational regulatory mechanisms, such as e.g. protein degradation. Additionally, these findings suggest distinct organ-specific functions of Alien $\alpha$  and Alien $\beta$  proteins.

Thus, in spite of high evolutionary conservation of alien mRNA and Alien protein isoforms, the expression patterns among different tissues are heterogeneous.

### **6.1.2 A tissue-specific alien mRNA and a putative novel Alien protein isoform suggest additional functions of Alien in rat adrenal gland**

Alien $\alpha$  was recently described to interact with the human orphan receptor DAX-1 expressed in adrenal and testis. Absence of DAX-1 expression is responsible for *adrenal hypoplasia congenita*, a human inherited disorder characterized by adrenal insufficiency and *hypogonatropic hypogonadism*. Naturally occurring mutants of the orphan receptor DAX-1 derived from patients suffering this syndrome, lack binding of the Alien corepressor. In these cases DAX-1 fails to silence target genes important for developmental processes (Muscatelli *et al.*, 1994; Crawford *et al.*, 1998; Altincicek *et al.*, 2000). Interestingly, Northern blot analysis of rat adrenal gland revealed next to the 2 kb and 4 kb RNA an additional 6kb alien messenger. Furthermore, on protein level a putative novel Alien protein isoform of approximately 28 kDa was found in rat adrenal gland. It still has to be investigated, whether the 6 kb mRNA codes for the novel putative Alien isoform. Furthermore, the functional roles of this tissue specific alien mRNA and the additional hypothetical Alien protein isoform remain unclear. However, it could be possible that such a putative adrenal gland-specific Alien isoform may hypothetically exhibit distinct interaction patterns with nuclear receptors or other interacting factors than Alien $\alpha$  and Alien $\beta$  and so may interfere in the natural development and function of the adrenal gland.

Taken together, Alien mRNA and protein expression patterns vary among tissues and cell types within the rat. These variations in Alien mRNA and protein expression may be modulated by tissue- or cell type-specific factors regulating Alien transcription or mRNA or protein stability.

## 6.2. Regulation of Alien expression by thyroid hormone

Thyroid hormone plays a crucial role during brain development by regulating the expression of target genes. The rat hypothyroid brain is a well-established model system for studies on gene regulation by thyroid hormone (Bernal, 2002). Multiple studies in this system revealed that TR-dependent gene regulation is severely altered due to the lack of adequate levels of thyroid hormone in hypothyroidism. Another disorder linked to thyroid hormone receptor function is the human syndrome of thyroid hormone resistance (RTH; reviewed in Tenbaum and Baniahmad, 1997 and Burke and Baniahmad, 2000). The RTH disorder is based on mutations of the TR $\beta$  gene and the main trait is the lack or reduction of response to thyroid hormone of target tissues. A clinical symptom is e.g. mental retardation indicating the importance of TR function in brain maturation mechanisms.

Alien $\alpha$  has been shown to participate in thyroid hormone receptor function by acting as a corepressor (Dressel *et al.*, 1999). Noteworthy, high Alien mRNA and protein expression was found in tissues of the CNS. Northern blot analyses using RNA from developing rat brain revealed a relatively low Alien expression at late embryonic stages and an increase up to postnatal day 10 in normal, control animals. Hypothyroidism does not change the developmental profile of Alien expression, but seems to induce a delay with respect to control conditions. A similar delay in expression and hormone-independent recovery have been described for most T3-regulated genes in brain as for example for myelin proteins, reelin or cerebellar genes (Alvarez-Dolado *et al.*, 1999; Oppenheimer and Schwartz, 1997; Rodriguez-Peña *et al.*, 1993; Bernal, 2002). Importantly, administration of T4, the precursor of T3, to hypothyroid animals partially recovered the amount of Alien RNA at P5. Additionally, severe reduction of alien RNA was observed in developing rat cerebellum, where TR has been shown to be essential for morphogenesis (Bernal, 2002; Morte *et al.*, 2002). These findings strongly suggest that the expression of Alien mRNA is dependent on thyroid hormone during brain development.

The pattern and time course of Alien expression during rat brain maturation correlate with that of thyroid hormone receptors, whose number increase at the end of the embryonic period, and are maximal by the end of the second postnatal week. Furthermore, the period of onset of Alien expression interestingly coincides with the period of maximal neuronal differentiation (Bradley *et al.*, 1992; Mellstrom *et al.*,

1991; Ferreiro *et al.*, 1990). The overall decrease of the alien mRNA in the hypothyroid brain is in agreement with the widespread presence of thyroid hormone receptors and additionally suggests a lack of modulation by local factors within the rat CNS.

Furthermore, studies in cultured cells derived from CNS proved that expression of Alien is under control of thyroid hormone. Alien mRNA was rapidly induced by T3 within two hours independently of receptor isoform in cells expressing either TR $\alpha$  or TR $\beta$ , but not in cells lacking significant amounts of TRs. The kinetic of induction was biphasic with decay of alien RNAs at 12 hours of T3-treatment and with a second increase up to 24 hours. These findings may suggest control of alien mRNA levels by secondary mechanisms. As one possibility there may exist a negative feed back loop between TR and its own corepressor. Thus, the secondary reduction of corepressor levels may be caused by gene expression mediated by liganded TR or non-genomic TR function. This rather may be an indirect mechanism, because Alien does not interact with TR in presence of T3 (Dressel *et al.*, 1999). Another possible explanation is regulation of alien mRNA stability as a response to high Alien levels. Such a mechanism would control corepressor levels and may trigger Alien functions.

The regulation of alien mRNA expression by T3 is reflected by changes in both Alien $\alpha$  and Alien $\beta$  protein levels. Both Alien isoforms were down regulated in hypothyroid primary rat brain tissues at postnatal day five. Furthermore, Alien $\alpha$  as well as Alien $\beta$  was induced by T3 in TR expressing neuroblastoma cells but not in cells expressing extremely low levels of thyroid hormone receptors. Both Alien forms, Alien $\alpha$  and Alien $\beta$ , interact with TR (Dressel *et al.*, 1999 and this work). Therefore, it may be speculated that down regulation of Alien in hypothyroidism during the crucial period of T3 action in brain maturation may contribute to abnormal TR function and thus could underlie to a certain extent the aberrant gene expression taking place in the hypothyroid brain. On the other hand, if the manifestations of hypothyroidism are due to repression by unliganded TR (Forrest and Vennstrom, 2000; Morte *et al.*, 2002), down regulation of Alien might attenuate such a repression and this may represent a compensatory mechanism.

These findings are in accordance to recent reports describing a similar regulation by T3 for the TR corepressor Hairless in rat brain (Potter *et al.*, 2001; Thompson, 1996). Thus, the regulation of TR corepressor levels may follow a more general principle in central nervous system



Therefore, it can be concluded that the T3-regulation of Alien gene expression represents a negative feed back mechanism. Thus, the reduction of corepressor levels may represent a control mechanism of TR-mediated gene silencing

Additionally, changes in Alien expression might affect COP9-signalosome complex (CSN) activity in the developing brain. Supporting this hypothesis, the Alien $\beta$  (CSN2) protein has been shown to be a subunit of the CSN and to be a limiting factor in COP9-signalosome assembly (Naumann *et al.*, 1999). Based on these findings it may be speculated that the hormonal regulation of Alien gene expression during brain development may also affect the wide ranged functionality of the signalosome.

Furthermore, down regulation of Alien proteins by T3 in brain may also influence the function of other Alien-interacting factors such as DAX1 that is specifically expressed in the hypothalamus and the pituitary (Guo *et al.*, 1995).

## 6.3 Comparison of Alien $\alpha$ and Alien $\beta$

### 6.3.1 Alien $\beta$ silences gene activation similar to Alien $\alpha$

One of the characteristics of a corepressor is to silence gene expression when tethered to DNA by fusion to a DNA-binding domain (DBD). This was already shown for Alien $\alpha$  (Dressel *et al.*, 1999). It was demonstrated in this work that a fusion of Alien $\beta$  with the DBD of the yeast protein Gal4 (Gal-Alien $\beta$ ) was able to repress transcription of a luciferase reporter gene harboring Gal4 binding sites in its promoter region to a similar extent than Gal-Alien $\alpha$ . Recent detailed characterization of Alien $\alpha$  revealed the existence of two different silencing domains, RD1 and RD2, within the Alien $\alpha$  protein (Dressel, unpublished data). Since the amino acid sequence of Alien $\beta$  contains the whole Alien $\alpha$  protein, both repression domains are present in Alien $\beta$ , too. Furthermore, interaction studies done here showed that Alien $\beta$  is also able to interact with the TR as demonstrated for Alien $\alpha$ . In regard to the silencing mechanism, it has been shown for Alien $\alpha$  that it is, at least in part, due to recruitment of Sin3-containing histone deacetylase (HDAC) complexes (Dressel *et al.*, 1999). Additionally, there were hints for participation of other HDAC-independent repression mechanisms such as binding to the basal transcription machinery (Dressel and Moehren, unpublished data). Thus,

Alien $\alpha$  and Alien $\beta$  have in common structural domains important for repression. Therefore, Alien $\beta$  is likely to mediate silencing by similar mechanisms; although it has to be verified in more detailed analyses whether Alien $\beta$  is also able to recruit HDAC complexes. There may be possible differences in silencing mechanisms or binding characteristics to transcriptional coregulators due to the additional C-terminal PCI-domain present in Alien $\beta$ .

### 6.3.2 Both Alien $\alpha$ and Alien $\beta$ stimulate AP1-driven transcription

The transcription factor AP1 is composed of heterodimers of subunits of the Jun and the Fos or ATF-families of proteins and binds to DNA binding sites in promoter regions of multiple target genes. Among the widespread physiological functions of AP1 are the control of proliferation, neoplastic transformation and apoptosis at least partly by regulation of expression of cell cycle regulators and tumor suppressors like p53, p16, p19<sup>ARF</sup>, p21<sup>Cip1/Waf1</sup> and cyclin D1 (Shaulian and Karin, 2001; Jochum *et al.*, 2001).

Alien $\beta$  (CSN2) has been reported to stimulate AP1-driven transcription by a poorly understood mechanism (Naumann *et al.*, 1999). The proposed mechanism of AP1 activation by Alien $\beta$  involves phosphorylation of the AP1 subunit c-Jun by a CSN-associated kinase activity independently of JNK (Naumann *et al.*, 1999). Within this hypothesis, overexpression of Alien $\beta$  is supposed to cause increased *de novo* assembly of CSN complexes resulting in increased phosphorylation rate of c-Jun. Stabilization of c-Jun through this phosphorylation would lead to increased transcriptional activity of AP1. This would represent an AP1 inducing pathway in parallel to the AP1-stimulating MAPKK-JNK cascade (Barr and Bogoyevitch, 2001).

In this work, it could be demonstrated that Alien $\alpha$  is able to induce AP1 transactivation in a dose-dependent manner and to a similar extent as that reported for Alien $\beta$ . This finding cannot be explained easily by the above-mentioned hypothesis, since in this case there are hints for diverging functions of Alien $\alpha$  and Alien $\beta$ .

Recent studies in the group of A. Baniahmad identified a MAPK kinase kinase, MLK2, as an Alien $\alpha$ -interacting protein (Eckey, unpublished data). Interestingly, MLK2 is an up-stream activating kinase of the JNK pathway and, as demonstrated here, Alien $\alpha$ , but not Alien $\beta$ , is substrate for MLK2 *in vitro*. These data suggest that at least Alien $\alpha$  may play a role in the MAPK cascade or may be regulated by this.

Both kinase activities, the CSN and JNK, are inhibited by the chemical compound curcumin, postulated to inhibit signal transduction at MAPKK kinase level indicating common up-stream elements for both kinase pathways (Chen and Tan, 1998; Henke *et al.*, 1999; Bech-Otschir *et al.*, 2001; Pollmann *et al.*, 2001). Because MLK2 acts up-stream of JNK (Hirai *et al.*, 1997), it could be possible that Alien $\alpha$  interfered with AP1-stimulating pathways on MLK2 level. Whether MLK2 represents an additional link to the CSN-associated kinase activity is still unknown.

Furthermore, it is not clear now, whether both Alien $\alpha$  and Alien $\beta$  act in the context of the CSN. On the one hand, both proteins may also function as non-complexed free proteins. Accordingly, Alien $\alpha$  lacks the C-terminal PCI-domain present in Alien $\beta$  thought to be responsible for integration in the CSN (Seeger *et al.*, 1998). On the other hand, the CSN is composed of eight core subunits and Alien $\beta$  interacts with at least five of them. The respective interaction domains, which are not completely mapped (Fu *et al.*, 2001; Kim *et al.*, 2001), putatively may be located in the part of the Alien $\beta$  protein that is identical to Alien $\alpha$ . Thus, it might be possible that Alien $\alpha$  also interacts with some of these subunits. Therefore, an isoform of the CSN containing Alien $\alpha$  instead of Alien $\beta$  could exist. Such a complex harboring a different set of subunits might exhibit some CSN-functions, including activation of AP1.

Another possible explanation for Alien $\beta$ -mediated AP1 activation emerges from the following findings. One of the Alien $\beta$ -interacting CSN subunits is CSN1 (GPS1) that is exclusively found in high molecular complexes (Karniol and Chamovitz, 2000). The PCI domain of Alien $\beta$  is essential for this interaction suggesting that CSN1 may not interact with Alien $\alpha$  (Tsuge *et al.*, 2001). CSN1 originally was identified as an inhibitor of the MAPK cascade able to repress AP1 transactivation in the context of the c-fos promoter (Spain *et al.*, 1996). Thus, the activating action of overexpressed Alien $\beta$  on AP1-driven transcription could hypothetically be due to sequestration of CSN1 as repressor of AP1, leading to derepression of AP1 regulated genes. Interestingly, AP1 regulates expression of c-Jun and c-Fos by a positive feedback loop further enhancing AP1 transactivation (Yang-Yen *et al.*, 1990). In consequence, this would lead to strong AP1 activity.

Thus, several mechanisms can be postulated to explain how Alien $\alpha$  and Alien $\beta$  could modulate the activation of AP1. Furthermore, despite their silencing potential both isoforms may act as transcriptional activators.

## **6.4 The identification of novel Alien-interacting factors and studies on non-hormonal regulation suggest possible roles of Alien isoforms in cell cycle regulation**

### **6.4.1 Alien $\alpha$ and Alien $\beta$ interact with important cell cycle regulators**

Alien $\alpha$  and Alien $\beta$  have here been found to interact with the transcription factors Rb and E2F. The retinoblastoma tumor suppressor and the transcription factor E2F play fundamental roles in regulation of cell cycle, growth control, differentiation and apoptosis (Dyson, 1998; Yamasaki, 1998; Yee *et al.*, 1998; Harbour and Dean, 2000a). Fluctuations in the activity of varying composed E2F complexes (here referred as E2F) enable target gene expression patterns depending on cell cycle stage.

A complex network of multiple kinases that change the phosphorylation status controls Rb function due to cell cycle state and intra- and extra-cellular stimuli. The most striking Rb actions are mediated through its ability to regulate gene expression in positive or negative fashion.

One of the most studied Rb pathways is the regulation of E2F-mediated transcription of genes important for S-phase transition (Harbour and Dean, 2000a). In this case, Rb silences the transactivation of E2F target genes by direct interaction with this transcription factor. Thereby, Rb recruits corepressor complexes or chromatin-remodeling enzymes to DNA-bound E2F. These complexes fall into three classes: histone deacetylase complexes (HDACs), the ATP-dependent SWI/SNF complex or HDAC independent corepressors. The corepressor Alien $\alpha$  silences gene transcription at least in part through recruitment of Sin3-containing HDAC complexes (Dressel *et al.*, 1999). Therefore, it has been investigated in this work, whether Alien isoforms may be able to bind to Rb. Using the yeast-two-hybrid system and *in vitro* GST-pulldown assays it could be shown that both Alien $\alpha$  and Alien $\beta$  interact with the silencing domain (small pocket domain; Rb-P) of the retinoblastoma protein via their far N-terminus (amino acids 1-66). The pocket domain of Rb has been defined as silencing domain due to its ability to actively repress transcription when tethered to DNA through the Gal4-DBD (Adnane *et al.*, 1995). Interestingly, a naturally occurring point mutation of the Rb pocket domain (C706F; Kaye *et al.*, 1990) that abolishes silencing by Rb (Weintraub *et al.*, 1995; Adnane *et al.*, 1995) neither binds Alien isoforms. Analogously, Alien $\alpha$  does not bind to mutants of the orphan receptor DAX1 that are defective in silencing gene expression of DAX1 target genes (Altincicek *et al.*, 2000).

Thus, Alien isoforms presumably could be involved in Rb-mediated repression. Although, overexpression of Alien $\alpha$  and Alien $\beta$  failed to modify silencing of the Gal4-DBD-fused Rb pocket domain under the experimental conditions applied during this work, this may be due to redundant pathways of Rb-mediated repression. In line with that, preliminary data of this work suggest interaction of the NCoR corepressor with the Rb pocket domain (data not shown) and various other Rb corepressors have been described (Luo *et al.*, 1998; De Luca *et al.*, 1998; Yee *et al.*, 1998; Meloni *et al.*, 1999; Lai *et al.*, 1999a; Tokitou *et al.*, 1999).

Another aspect emerges from the information that at least the Alien $\alpha$  isoform mediates repression partly independently of HDAC activity by interaction with basal transcription factors (Dressel *et al.*, 1999; Dressel and Möhren unpublished results). For this reason, interaction of Alien isoforms with Rb could be involved in alternative repression mechanisms. Accordingly, it has been theorized that distinct Rb-corepressor complexes may target different genes in different phases of the cell cycle (Zhang *et al.*, 2000). For instance, Rb regulates S-phase progression via its interaction with SWI/SNF complexes. Rb-SWI/SNF thereby seems to be required to repress cyclin A and p34cdc2 gene expression at instants of cell cycle progression when phosphorylation by cyclin D-cdk4/6 already abolished binding of HDAC complexes to Rb. It is speculated that HDAC independent corepressors may be necessary for this Rb-SWI/SNF-mediated inhibition (Harbour and Dean, 2000a). Therefore, Rb may be considered to act in combination with Alien isoforms independently from HDAC in analogous situations. Thus, Alien isoforms could possibly play a role in such alternative Rb-mediated repression mechanisms restricted to certain time points in the cell cycle or to specific physiological circumstances.

*In vitro* binding assays revealed that both Alien $\alpha$  and Alien $\beta$  are capable to associate with E2F1. The effect of this interaction *in vivo* was studied in transient transfection assays using a reporter gene harboring E2F binding sites in its promoter region. Interestingly, Alien $\alpha$  but not Alien $\beta$  efficiently repressed transactivation by E2F. In view of the fact that there is extensive redundancy in binding specificity of members of the E2F-family to its response elements, it cannot be deduced which E2F isoform might mediate this effect. Further detailed studies are necessary to determine the binding characteristics of Alien $\alpha$  and Alien $\beta$  to the E2F-family.

Interestingly, the cell line C33A used in these assays is defective for functional Rb and harbor extremely diminished levels of BRG1, a core unit of the SWI/SNF complex (Murphy *et al.*, 1999; Zhang *et al.*, 2000; Harbour and Dean, 2000a). Therefore, repression of E2F-mediated transactivation by Alien $\alpha$  is likely to be independent of Rb and SWI/SNF chromatin remodeling activity and may be due to interference of Alien $\alpha$  with the basal transcription machinery or to a yet unknown mechanism.

Thus, Alien $\alpha$  but not by Alien $\beta$  mediates efficient repression of transactivation promoted by E2F binding sites, although both Alien isoforms interact with E2F1 *in vitro*. This finding represents another example for differences in the *in vivo* mode of action of Alien $\alpha$  and Alien $\beta$ . It remains unclear which molecular determinants contribute to equal or distinct functional behavior of Alien $\alpha$  and Alien $\beta$ .

#### 6.4.2 Alien $\beta$ interferes with the Rb-Sp1 pathway

In several occasions, Rb has been described to activate transcription. Rb induces among others the expression of genes coding for the human insulin receptor, TGF $\beta$ , c-Fos, Cyclin D1 and p21<sup>Cip1/Waf1</sup> as well as for the Werner-helicase and the dihydrofolate reductase (Kim *et al.*, 1991; Muller *et al.*, 1994; Shen *et al.*, 1995; Noe *et al.*, 1997; Yamabe *et al.*, 1998; ; Decesse *et al.*, 2001). Thereby, Rb acts in concert with a variety of transcription factors such as Myo-D, Sp- and ATF-family proteins mediating activation of these genes (Kim *et al.*, 1992a; Kim *et al.*, 1992b; Gu *et al.*, 1993; Yee *et al.*, 1998; Li and Wicks, 2001).

Investigating the influence of Alien isoforms on Gal-Rb-mediated transcriptional activity it was confirmed here that Gal-Rb may activate reporter constructs containing Sp1 DNA binding sites. Surprisingly, Alien $\beta$  but not Alien $\alpha$  abolished the Rb-mediated transactivation without affecting basal Sp1 activity. The findings suggested that Alien $\beta$  in this case might interfere with the Rb-mediated superactivation of Sp1-driven transcription. Interestingly, the Rb pocket domain formerly defined as the Rb silencing domain (Adnane *et al.*, 1995), was sufficient for this activation. Furthermore, the silencing-deficient Rb mutant C706F failed to superactivate Sp1 indicating that the pocket domain may be the surface for Rb-Sp1 interaction. Several reports proposed indirect mechanisms for this Rb-mediated effect on Sp1 transactivation. Some of these mechanisms involve functional interaction of Rb with Sp1, although direct interaction has not been shown (Udvadia *et al.*, 1993; Udvadia *et al.*, 1992; Udvadia *et al.*, 1995). Thereby, Rb is believed to superactivate Sp1 by contacting the basal transcription

machinery through the TBP-associated factor TAF<sub>II</sub>250. However the mechanism of activation is up to date not fully understood (Adnane *et al.*, 1999; Siegert and Robbins, 1999). Another documented explanation for the Sp1-activating Rb function could be squelching for common interacting factors like MDM2 or Sp1-I, factors negatively regulating Sp1 (Chen *et al.*, 1994; Johnson-Pais *et al.*, 2001).

Interestingly, *in vitro* binding assays performed in this work revealed that Rb directly binds to Sp1. Alien $\beta$  interferes with this interaction in a dose-dependent manner. Because Alien $\beta$  directly binds to Rb as shown in this work, this suggests a possible competition of Alien $\beta$  for the pocket domain as common interaction surface for interaction of Sp1 and Alien $\beta$  towards Rb.

Given that there appeared to be degradation products of *in vitro*-translated Rb in this competition experiments, it cannot be ruled out that this interference of Alien $\beta$  with binding of Rb to Sp1 could imply protein degradation mechanisms. Correspondingly, Rb and Alien $\beta$  have been found to associated with protease activities (Fu *et al.*, 1998; Nishinaka *et al.*, 1997; Lyapina *et al.*, 2001). The rabbit reticulocyte lysate used in these experiments may contain such proteases. In addition, the Alien $\beta$  containing signalosome has been linked to protein degradation mechanisms that presumably could be implicated (Schwechheimer and Deng, 2001a; Schwechheimer *et al.*, 2001b; Bech-Otschir *et al.*, 2001; Lyapina *et al.*, 2001; Tomoda *et al.*, 2002; Zhou *et al.*, 2001; Yang *et al.*, 2002). It should be the purpose of future studies to find out why this interference with Rb-Sp1 is restricted to Alien $\beta$ . Alien $\alpha$  theoretically might collaborate with Rb in different molecular contexts.

The Sp-family of transcription factors plays important roles in early development regulating a large number of genes by means of a complex transcriptional network (Lania *et al.*, 1997; Black *et al.*, 2001). Rb-mediated superactivation of Sp1-driven transcription might represent a fine-tuning cell cycle-dependent regulation of Sp1. Interference of Alien $\beta$  with this pathway may be crucial to counteract Rb action on Sp1 in a tissue-specific manner or in developmental processes. The discovery, that the Rb-Sp1 pathway is modulated by Ca<sup>2+</sup>/calmodulin kinases II and IV, which are associated to growth control and differentiation in a cell type-specific fashion, supports this hypothesis (Sohm *et al.*, 1999).

The modulation of the Rb-Sp1-pathway by Alien $\beta$  may also be affected in the period of maximal neuronal differentiation in the hypothyroid brain when Alien expression is deregulated by the lack of T3.

Taken together, these data suggest a novel mechanism of modification of Rb-mediated transcriptional regulation by Alien $\beta$  *in vivo* and additionally, demonstrate functional differences between Alien $\alpha$  and Alien $\beta$ .

#### 6.4.3 Induction of Alien expression in confluent cells

Northern blot analysis in N2A neuroblastoma cells gave hints on the existence of a second thyroid hormone independent mechanism of Alien regulation. In absence of thyroid hormone, alien mRNAs were induced in confluent respective to sub-confluent cell cultures. Several possible mechanisms could lead to this increase in alien gene expression.

N2A neuroblastoma cells were originally derived from a spontaneous tumor of mouse CNS. They lack transforming tumor viruses (Klebe *et al.*, 1970; Information ATCC N $^{\circ}$ : CCL-131) and present a non-transformed differentiating phenotype in cell culture (Lebel *et al.*, 1994).

Generally, sub-confluent growing cells proliferate executing the complete cell cycle. Environmental events like cell-cell contact, lack of nutrients or growth factors that prevent the cell from traversing the so-called restriction point of the cell cycle at the G1/S border, drive the cell into a quiescent state known as G0-phase. The numerous processes involved in the density-dependent inhibition of cell division are commonly termed as contact inhibition (Alberts *et al.*, 1994). Thus, most of the N2A cells of the confluent cell cultures showing increased alien mRNA levels could have entered a quiescent state upon cell-cell contact.

One way by which quiescent mammalian cells differ from their proliferating counterparts is that they do not transcribe a number of genes required for cell proliferation such as those that encode certain cyclins, cyclin-dependent kinases (Cdks), replication factors and some enzymes of nucleotide metabolism. Genes activated during entry in G0 are involved in trans-membrane signaling, cytoskeletal reorganization, and transcriptional control that initiate and maintain a quiescent phenotype (Bouchard *et al.*, 1998; Nelson and Daniel, 2002). On one hand, Alien gene expression could be induced as a consequence of the action of those factors up regulated during cell-cell contact or quiescence. On the other hand, down regulated expression of a hypothetical repressor of alien expression or its functional inactivation during contact inhibition could augment alien mRNA levels. In addition, alien mRNA stability may also be affected. Since a large number of genes are down regulated in quiescent cells higher levels of



corepressors would contribute to maintain target genes silenced. Elevated Alien expression could therefore potentially participate in initial steps of establishment of the quiescent phenotype and its preservation.

Furthermore, it should be considered that up regulation of alien gene expression might be involved in mechanisms like differentiation rather than in the quiescent phenotype. TR expressing N2A cells differentiate upon T3 treatment. Thereby, T3 blocks proliferation and arrests cells in G0/G1-phase (Lebel *et al.*, 1994). Thus, T3 action triggers differentiation pathways that merge in transcriptional events (Bottazzi and Assoian, 1997; Schwartz and Assoian, 2001) that possibly could lead to induction of alien gene expression.

Thus, further investigations are necessary to define the mechanisms that lead to elevated alien mRNA content in confluent respective to sub-confluent growing N2A-TR $\beta$  neuroblastoma cells. It would also be important to know whether this correlates with changes in cell cycle stage or with initiation of differentiation.

#### **6.4.4 Both Alien isoforms are phospho-proteins *in vivo* and interact with kinases**

Changes in kinase activity and phosphorylation status of regulatory proteins are some of the most striking events during cell cycle transition (Alberts *et al.*, 1994).

*In vivo* labeling of exogenously expressed Alien isoforms using  $^{32}\text{P}$ -ortho-phosphate revealed that both Alien $\alpha$  and Alien $\beta$  are phosphorylated in HEK293 cells. Additionally, GST-pulldown/kinase-assay experiments in total extracts of these cells applying GST-Alien $\alpha$  and GST-Alien $\beta$  demonstrated that both proteins bind to and are substrate for an up to date unknown kinase activity present in these extracts. This kinase activity appears to be slightly more active in growing than in confluent cells. This finding may hypothetically indicate that this kinase activity could be more active in cycling than in quiescent cells or may be inhibited by mechanisms involved in cell-cell contact mechanisms. In line with previously described results, this may suggest cell cycle dependence of Alien phosphorylation status.

Due to the experimental conditions of this assay, participation of several different kinases cannot be ruled out. Therefore, the observed phosphorylation of Alien isoforms may result from cumulative phosphorylation by distinct kinases.

Thus, Alien $\alpha$  and Alien $\beta$  have to be considered as potential targets of kinase pathways perhaps partly in a cell cycle-dependent manner.

Further characterization of this kinase activity via *in gel* kinase assays demonstrated that indeed there are at least two different kinases of approximately ~35 kDa and ~42 kDa in lysates of HEK293 cells able to phosphorylate at least Alien $\beta$ . Database searches querying for known kinases of these molecular weights at *Protein Kinase Resource* ([http://pkr.sdsc.edu/html/proteomics\\_search.shtml](http://pkr.sdsc.edu/html/proteomics_search.shtml)) delivered 19 kinases of 35 $\pm$ 1 kDa and 23 of 42 $\pm$ 1 kDa (Figure 57 A & B, see appendix). It is obvious that no definite conclusion can be made in view of this number of possible kinases with these molecular weights. Additionally, it can not be ruled out at present, that the detected signals could be due to functional breakdown products of kinases of higher molecular weights. Further lines of investigation have to be opened to identify participating kinases. However, some of the found kinases should be emphasized. Among the kinases coinciding in size with the results of the *in gel* kinase assays, there are several members of MAPK- and cyclin-dependent kinase- as well as of the PKA families of protein kinases.

Interestingly, the Alien $\beta$ -containing CSN is proposed to be involved in cell cycle regulation and mitogen-activated signaling (Claret *et al.*, 1996; Spain *et al.*, 1996; Mahalingam *et al.*, 1998; Naumann *et al.*, 1999; Tomoda *et al.*, 1999; Mundt *et al.*, 1999; Tomoda *et al.*, 2002; Yang *et al.*, 2002). Furthermore, Alien $\alpha$  and Alien $\beta$  induce transactivation by AP1, a transcription factor induced as well by MAP-kinases (Naumann *et al.*, 1999; Hunter, 2000; Barr and Bogoyevitch, 2001 and this work). Concerning PKA, there are preliminary results in the group of A. Baniahmad suggesting a possible phosphorylation of Alien isoforms by PKA (Möhren, unpublished data). Thus, further investigations are necessary to determine the kinase networks responsible for phosphorylation of Alien isoforms.

#### **6.4.5 Alien $\alpha$ and Alien $\beta$ are substrates for the cyclin-dependent kinase p34cdc2.**

As described in detail before, there are multiple hints such as the presence of a putative consensus sequence for phosphorylation by p34cdc2 and participation of proteins interacting with Alien isoforms like Rb, E2F and the COP9-signalosome subunit CSN6/hVIP in molecular events involving p34cdc2; (Kapelari *et al.*, 2000; [Dou, 1992 #343; Arroyo, 1993 #344; van Wijnen, 1996 #342; Taieb *et al.*, 1998; Mahalingam *et al.*, 1998; Hayashi, 1999 #341]). *In vitro* kinase assays using p34cdc2 kinase revealed that both Alien $\alpha$  and Alien $\beta$  are substrates of this kinase.

With the purpose to verify these findings, similar assays were performed with anti-Cyclin A and B antibodies. Cyclin A or B are regulatory subunit of the activated p34cdc2 kinase to form the Cdk1 complex (Lew and Kornbluth, 1996). Immunoprecipitation using either anti-Cyclin A or anti-Cyclin B antibody led to isolation of kinase complexes able to phosphorylate Alien $\alpha$  and Alien $\beta$  *in vitro*. Cyclin B interacts exclusively with p34cdc2, so that this result fully confirms that Alien isoforms are substrate of Cdk1 *in vitro*.

Differently, Cyclin A is able to form complexes with p34cdc2 resulting in the cyclin-dependent kinase complex Cdk1 (Lew and Kornbluth, 1996). Furthermore, Cyclin A functionally interacts with p35cdc2 to form Cdk2 another member of the cyclin-dependent kinase family. Thus, the results obtained using the anti-Cyclin A antibody again indicate that Alien isoforms are phosphorylated by Cdk1 *in vitro* but do not exclude a possible phosphorylation by Cdk2, which remains to be investigated.

Taken together these findings suggest that Alien $\alpha$  and Alien $\beta$  are phosphorylated during mitosis.

One of the most striking processes during mitosis is complete chromatin condensation (Alberts *et al.*, 1994). To date it is not clear whether HDAC complexes directly participate in this process. However, HDAC phosphorylation is increased in cells arrested in mitosis by nocodazol treatment and HDAC function is therefore regulated during mitosis (Wang *et al.*, 2001; Galasinski *et al.*, 2002). This post-translational modification disrupts interaction of HDAC with Sin3A. It was proposed that this might represent a switch between deacetylase-catalyzed and HDAC-independent transcriptional repression during mitosis. At least Alien $\alpha$  has been shown to interact with Sin3 proteins (Dressel *et al.*, 1999; Dressel and Moehren unpublished data) and potentially may bridge Sin3 complexes to cell cycle regulatory proteins like Rb or E2F. Furthermore, it was postulated that Alien $\alpha$  mediates HDAC-dependent as well as HDAC-independent transcriptional repression. Therefore, it may be possible that phosphorylation events during mitosis such as HDAC phosphorylation and phosphorylation of Alien proteins by p34cdc2 putatively could determine the way of repression mediated by Alien $\alpha$ . It remains to be investigated whether also Alien $\beta$  binds to Sin3 proteins; however, the transcriptional repression potential of Alien $\beta$  is comparable to its isoform Alien $\alpha$  and suggests analogous mechanisms.

Another important mechanism during transition through mitosis is protein degradation. During this cell cycle phase, the cell runs an orderly timed program of degradation of regulatory proteins (Harper, 2001; Lees, 1995). For example, Cyclin A is degraded exactly at the end of metaphase, whereas Cyclin B disappears in anaphase inactivating p34cdc2, requiring a stepwise regulation of protein degradation mechanisms. The signalosome (CSN) has been shown to regulate protein degradation (Schwechheimer and Deng, 2001a; Schwechheimer *et al.*, 2001b; Bech-Otschir *et al.*, 2001; Lyapina *et al.*, 2001; Tomoda *et al.*, 2002; Zhou *et al.*, 2001; Yang *et al.*, 2002). These regulatory mechanisms, mediated by the CSN, affect cell cycle progression and interestingly seem to depend directly on Alien $\beta$  and have been shown to affect the cell cycle at least at the G1/S and S/G2 borders (Mahalingam *et al.*, 1998; Mundt *et al.*, 1999; Yang *et al.*, 2002). Phosphorylation of the CSN-integrating subunit Alien $\beta$  by p34cdc2 presumably could influence assembly or activity of the CSN during the short period of mitosis and thereby regulate CSN-dependent protein degradation and cell cycle regulation.

## 6.5 Outlook

An important line of investigation that should be opened based on the results of this work is the analysis of function of Alien isoforms during the cell cycle.

The regulation of Alien expression in TR-expressing N2A Neuroblastoma cells lines represents an excellent tool for investigation of diverse Alien functions in presence or absence of thyroid hormone controlling endogenous Alien levels. Since Alien isoforms presumably are involved in cell cycle regulation, it would be interesting to investigate, whether there are changes in cell cycle transition upon T3 treatment and in what way this could be linked to Alien function.

In view of the phosphorylation of Alien isoforms by p34cdc2 and with the purpose to further define the function of this modification, it would be necessary to identify the exact amino acid residues in both Alien $\alpha$  and Alien $\beta$  that are target of p34cdc2 action via phospho-peptide mapping. Site directed mutagenesis of these amino acids should result in Alien-mutants defective for functions mediated by p34cdc2, which could be used in transfection and interaction assays or FAC-Scan analyses to narrow down the biological function of Alien isoforms.

Furthermore it would be helpful to identify the binding specificities of Alien $\alpha$  towards the different members of the E2F family of transcription factors. This would give evidences for the cellular context and cell cycle stage of Alien/E2F crosstalk.

Data obtained studying Alien tasks in the cell cycle might also clarify roles that Alien isoforms have on Rb function.

Another line of investigation worth for future studies is to find out, whether Alien mRNA stability is regulated. The half-life of alien mRNA can be measured by Northern blot in TR-expressing N2A cells treated or not with T3 in combination with cycloheximide and actinomycin. Pulse chase experiments would provide data on the stability of Alien proteins. Furthermore, there are several RNA binding factors identified that bind to A/U-rich elements such as the members of the HU family. Binding of such factors to alien mRNAs can be assayed by RNA-binding experiments using *in vitro*-transcribed alien mRNA and recombinant RNA-binding factors. Regulation of Alien levels by such mechanisms would represent a novel form of regulation of thyroid hormone receptor function.

Additionally, it would be interesting to shed light on the function of Alien isoforms in the adrenal gland. Therefore, cloning of the putative Alien isoform, detected in this tissue by RT-PCR, would possibly provide a novel Alien protein that should be functionally compared to Alien $\alpha$  and Alien $\beta$ .

## 6.6. Appendix

Kinase 35 kDa+/- 1kDa	Accession number
<b>Cdc2-Related Protein Kinase</b>	GenPept: AAA60092.2
<b>p34 Protein Kinase;</b> <b>Cyclin-Dependent Kinase 1 (Cdk1);</b> <b>Cell Division Control Protein 2 Homolog (hCdc2)</b>	Swiss-Prot: P06493
<b>Cell Division Protein Kinase 3 (hCdc3)</b>	Swiss-Prot: Q00526
<b>Cyclin-Dependent Kinase 5 Activator 1 Precursor (Cdk5 Activator 1)</b> <b>Cyclin-Dependent Kinase 5 Regulatory Subunit 1 Tau Protein Kinase II 23 kDa Subunit (TPKII Regulatory Subunit)</b>	Swiss-Prot: Q15078
<b>Protein kinase C-gamma; PKC<math>\gamma</math></b>	GenPept: AAA60102.1
<b>Mxi2</b>	GenPept: AAC50329.1
<b>KRCT Serine/Threonine Kinase</b>	AF203910 GenPept: AAG23728.1
<b>SID6-1512 Protein Kinase / NIMA (Never In Mitosis Gene A)-Related Kinase 6</b>	TrEMBL: Q9ULX2
<b>c-FGR peptide</b>	GenPept: AAA52762.1
<b>HSPC187</b>	TrEMBL: Q9P0T6
<b>AIE2 Serine/Threonine Kinase</b>	TrEMBL: O75442
<b>AIK-3 (AURORA/IPL1-Related Kinase 3)</b>	TrEMBL: Q9UQB9
<b>PIM-1</b> <b>Proto-Oncogene Serine/Threonine-Protein Kinase</b>	Swiss-Prot: P11309
<b>PIM-2 Protooncogene Homolog</b>	TrEMBL: Q9P1W9
<b>Protein Activator of the Interferon-Induced Protein Kinase (Hypothetical 34.4 kDa Protein)</b>	TrEMBL: O75569
<b>RACK1 (Receptor of Activated Protein Kinase C 1)</b> <b>GNB2-RS1 (Guanine Nucleotide-Binding Protein Beta Subunit-Like)</b> <b>Protein 12.3 (p205)</b>	Swiss-Prot: P25388
<b>Protein Kinase PKL12</b> <b>Myristoylated and Palmitoylated Serine-Threonine Kinase (MPSK)</b> <b>TGF<math>\beta</math> Stimulated Factor 1 (TSF-1) (HPSK)</b> <b>Serine/Threonine Protein Kinase 16</b>	Swiss-Prot: O75716
<b>Serum-Inducible Kinase</b>	GenPept: AAD00575.1
<b>Serine/Threonine Kinase</b>	GenPept: CAA09387.1

**Fig. 57 A: Protein kinases of molecular weight of 35 +/-1 kDa.** The result of a query for protein kinases of 35+/-1 kDa at *Protein Kinase Resource* ([http://pkr.sdsc.edu/html/proteomics\\_search.shtml](http://pkr.sdsc.edu/html/proteomics_search.shtml)) is shown. The most common names of the kinases are highlighted. Duplicate entries were discarded and accession numbers are annotated.

Kinase 42 kDa+/- 1 kDa	Accession number
<b>Casein Kinase II, Alpha Chain (CK II)</b>	Swiss-Prot: P19784
<b>Calcium/Calmodulin-Dependent Protein Kinase Type I (CaM Kinase I)</b>	Swiss-Prot: Q14012
<b>Cell Division Protein Kinase 9 (CDK 9) Serine/Threonine-Protein Kinase PITALRE (C-2K)</b>	Swiss-Prot: P50750
<b>Cell Division Protein Kinase 10 (CDK10) Serine/Threonine-Protein Kinase PISLRE</b>	Swiss-Prot: Q15131
<b>Cyclin-Dependent Kinase-Like 1 human cdc2-related protein kinase Serine/Threonine-Protein Kinase KKIALRE</b>	Swiss-Prot: Q00532
<b>Extracellular Signal- Regulated Kinase-1 (ERK-1)</b>	GenPept: AAA36142.1
<b>Extracellular Signal- Regulated Kinase 2 (ERK-2) Mitogen-Activated Protein Kinase 2 (MAPK 2) (p42-MAPK) (ERT-1)</b>	Swiss-Prot: P28482
<b>3pK / MAPK-activated protein kinase 3 (MAPKAPK-3)</b>	PIR: JC6094
<b>Mitogen-Activated Protein Kinase p38 beta (p38<math>\beta</math>) (p38-2) Stress- Activated Protein Kinase-2 Mitogen-Activated Protein Kinase 11</b>	Swiss-Prot: Q15759
<b>Extracellular Signal-Regulated Kinase 6 (ERK-6) Mitogen-Activated Protein Kinase p38 gamma Stress-Activated Protein Kinase-3 Mitogen-Activated Protein Kinase 12</b>	Swiss-Prot: P53778 GenPept: CAA55984.1 PIR: JC6138
<b>Mitogen-Activated Protein Kinase p38 delta Stress-Activated Protein Kinase-4 Mitogen-Activated Protein Kinase 13</b>	Swiss-Prot: O15264
<b>Cytokine Suppressive Anti- Inflammatory Drug Binding Protein (CSAID Binding Protein) (CSBP-2) Mitogen-Activated Protein Kinase 14 Max-Interacting Protein 2 (Mxi2)-isoform )</b>	Swiss-Prot: Q16539
<b>Protein Kinase C delta (PKC<math>\delta</math>)</b>	GenPept: CAA80249.1
<b>Protein Kinase A-catalytic-subunit Cy (PKA-C gamma)</b>	PIR: OKHUCG
<b>DAP-Kinase Related Protein 1</b>	TrEMBL: O75892
<b>Death-Associated Protein Kinase 2</b>	TrEMBL: Q9UIK4
<b>DAP Kinase-Related Apoptosis-Inducing Protein Kinase 2 (Serine/Threonine Kinase 17B)</b>	Swiss-Prot: O94768
<b>Tyrosine Kinase t-Ror-1</b>	GenPept: AAC50714.1
<b>G-Protein-Coupled Receptor Induced Protein GIG2</b>	TrEMBL: Q9H2Y8
<b>c-AMP-Dependent Protein Kinase Type I-Alpha Regulatory Chain (PKA-regulatory subunit) Tissue- Specific Extinguisher-1 (TSE-1)</b>	Swiss-Prot: P10644
<b>SGK-2 (Serum/Glucocorticoid Regulated Kinase 2) Protein Kinase (DJ138B7.2)</b>	TrEMBL: Q9UKG6
<b>Synaptotagmin V</b>	Swiss-Prot: O00445
<b>41kD protein kinase</b>	GenPept: CAA77752.1

**Fig. 57 B: Protein kinases of molecular weight of 42 +/-1 kDa.** The result of a query for protein kinases of 42+/-1 kDa at *Protein Kinase Resource* ([http://pkr.sdsc.edu/html/teomics\\_search.shtml](http://pkr.sdsc.edu/html/teomics_search.shtml)) is shown. The most common names of the kinases are highlighted. Duplicate entries were discarded and accession numbers are annotated.

## 7. Bibliography

- Abrieu, A., Doree, M., and Fisher, D. (2001). The interplay between cyclin-B-Cdc2 kinase (MPF) and MAP kinase during maturation of oocytes. *J Cell Sci* **114**, 257-67.
- Achermann, J. C., Weiss, J., Lee, E. J., and Jameson, J. L. (2001). Inherited disorders of the gonadotropin hormones. *Mol Cell Endocrinol* **179**, 89-96.
- Adnane, J., Shao, Z., and Robbins, P. D. (1999). Cyclin D1 associates with the TBP-associated factor TAF(II)250 to regulate Sp1-mediated transcription. *Oncogene* **18**, 239-47.
- Ahmad, W., Faiyaz ul Haque, M., Brancolini, V., Tsou, H. C., ul Haque, S., Lam, H., Aita, V. M., Owen, J., deBlaquiere, M., Frank, J., Cserhalmi-Friedman, P. B., Leask, A., McGrath, J. A., Peacocke, M., Ahmad, M., Ott, J., and Christiano, A. M. (1998). Alopecia universalis associated with a mutation in the human hairless gene. *Science* **279**, 720-4.
- Alberts, B., Bray, D., Lewis, J., Raff, M., and Watson, J. D. (1994). "Molecular Biology of the Cell." Garland Publishing Inc., New York.
- Alland, L., Muhle, R., Hou, H., Jr., Potes, J., Chin, L., Schreiber-Agus, N., and DePinho, R. A. (1997). Role for N-CoR and histone deacetylase in Sin3-mediated transcriptional repression. *Nature* **387**, 49-55.
- Altincicek, B., Tenbaum, S. P., Dressel, U., Thormeyer, D., Renkawitz, R., and Baniahmad, A. (2000). Interaction of the corepressor Alien with DAX-1 is abrogated by mutations of DAX-1 involved in adrenal hypoplasia congenita. *J Biol Chem* **275**, 7662-7.
- Altman, J., and Bayer, S. A. (1997). "Development of the cerebellar system." CRC Press, Boca Raton.
- Alvarez-Dolado, M., Gonzalez-Sancho, J. M., Bernal, J., and Munoz, A. (1998). Developmental expression of the tenascin-C is altered by hypothyroidism in the rat brain. *Neuroscience* **84**, 309-22.
- Alvarez-Dolado, M., Ruiz, M., Del Rio, J. A., Alcantara, S., Burgaya, F., Sheldon, M., Nakajima, K., Bernal, J., Howell, B. W., Curran, T., Soriano, E., and Munoz, A. (1999). Thyroid hormone regulates reelin and dab1 expression during brain development. *J Neurosci* **19**, 6979-93.
- Angel, P., Hattori, K., Smeal, T., and Karin, M. (1988). The jun proto-oncogene is positively autoregulated by its product, Jun/AP-1. *Cell* **55**, 875-85.
- Aranda, A., and Pascual, A. (2001). Nuclear hormone receptors and gene expression. *Physiol Rev* **81**, 1269-304.
- Arroyo, M., Bagchi, S., and Raychaudhuri, P. (1993). Association of the human papillomavirus type 16 E7 protein with the S-phase-specific E2F-cyclin A complex. *Mol Cell Biol* **13**, 6537-46.
- Ausrubel, F. M., Brent, R., Kingston, R. E., Moore, D. D., Seidmann, I. G., Smith, J. A., and Struhl, K. (1989). "Current protocols in molecular biology." Greene Publishing Associates and Wiley-Interscience, New York, Chichester, Brisbane, Toronto, Singapore.
- Bailey, P., Downes, M., Lau, P., Harris, J., Chen, S. L., Hamamori, Y., Sartorelli, V., and Muscat, G. E. (1999). The nuclear receptor corepressor N-CoR regulates differentiation: N-CoR directly interacts with MyoD. *Mol Endocrinol* **13**, 1155-68.
- Baniahmad, A., Ha, I., Reinberg, D., Tsai, S., Tsai, M. J., and O'Malley, B. W. (1993). Interaction of human thyroid hormone receptor beta with transcription factor TFIIB may mediate target gene derepression and activation by thyroid hormone. *Proc Natl Acad Sci U S A* **90**, 8832-6.



- Baniahmad, A., Kohne, A. C., and Renkawitz, R. (1992).** A transferable silencing domain is present in the thyroid hormone receptor, in the v-erbA oncogene product and in the retinoic acid receptor. *Embo J* **11**, 1015-23.
- Baniahmad, A., Leng, X., Burriss, T. P., Tsai, S. Y., Tsai, M. J., and O'Malley, B. W. (1995).** The tau 4 activation domain of the thyroid hormone receptor is required for release of a putative corepressor(s) necessary for transcriptional silencing. *Mol Cell Biol* **15**, 76-86.
- Baniahmad, A., Thormeyer, D., and Renkawitz, R. (1997).** tau4/tau c/AF-2 of the thyroid hormone receptor relieves silencing of the retinoic acid receptor silencer core independent of both tau4 activation function and full dissociation of corepressors. *Mol Cell Biol* **17**, 4259-71.
- Barr, R. K., and Bogoyevitch, M. A. (2001).** The c-Jun N-terminal protein kinase family of mitogen-activated protein kinases (JNK MAPKs). *Int J Biochem Cell Biol* **33**, 1047-63.
- Barrera-Saldana, H., Takahashi, K., Vigneron, M., Wildeman, A., Davidson, I., and Chambon, P. (1985).** All six GC-motifs of the SV40 early upstream element contribute to promoter activity in vivo and in vitro. *Embo J* **4**, 3839-49.
- Batsche, E., Lipp, M., and Cremisi, C. (1994).** Transcriptional repression and activation in the same cell type of the human c-MYC promoter by the retinoblastoma gene protein: antagonisation of both effects by SV40 T antigen. *Oncogene* **9**, 2235-43.
- Bech-Otschir, D., Kraft, R., Huang, X., Henklein, P., Kapelari, B., Pollmann, C., and Dubiel, W. (2001).** COP9 signalosome-specific phosphorylation targets p53 to degradation by the ubiquitin system. *Embo J* **20**, 1630-9.
- Bernal, J. (2002).** Thyroid hormones and brain development. In "Hormones, Brain and Behavior" (D. Pfaff, A. Arnold, A. Etgen, S. Fahrbach, R. Moss, and R. Rubin, Eds.). Academic Press, San Diego, CA, USA.
- Bernal, J., and Nunez, J. (1995).** Thyroid hormones and brain development. *Eur J Endocrinol* **133**, 390-8.
- Biggs, J. R., Kudlow, J. E., and Kraft, A. S. (1996).** The role of the transcription factor Sp1 in regulating the expression of the WAF1/CIP1 gene in U937 leukemic cells. *J Biol Chem* **271**, 901-6.
- Black, A. R., Black, J. D., and Azizkhan-Clifford, J. (2001).** Sp1 and kruppel-like factor family of transcription factors in cell growth regulation and cancer. *J Cell Physiol* **188**, 143-60.
- Bottazzi, E. M., and Assoian, R. K. (1997).** The extracellular matrix and mitogenic growth factors control G1 phase cyclins and cyclin-dependent kinase inhibitors. *Trends in Cell Biology* **7**, 348-352.
- Bouchard, C., Staller, P., and Eilers, M. (1998).** Control of cell proliferation by Myc. *Trends Cell Biol* **8**, 202-6.
- Boyer, H. W., and Roulland-Dussoix, D. (1969).** A complementation analysis of the restriction and modification of DNA in Escherichia coli. *J Mol Biol* **41**, 459-72.
- Bradley, D. J., Towle, H. C., and Young, W. S., 3rd. (1992).** Spatial and temporal expression of alpha- and beta-thyroid hormone receptor mRNAs, including the beta 2-subtype, in the developing mammalian nervous system. *J Neurosci* **12**, 2288-302.
- Brent, G. A. (1994).** The molecular basis of thyroid hormone action. *N Engl J Med* **331**, 847-53.
- Brooke, H. C. (1926).** Hairless mice. *J. Heredit.* **17**, 173-174.
- Burke, L. J., and Baniahmad, A. (2000).** Co-repressors 2000. *Faseb J* **14**, 1876-88.

- Cachon-Gonzalez, M. B., Fenner, S., Coffin, J. M., Moran, C., Best, S., and Stoye, J. P. (1994).** Structure and expression of the hairless gene of mice. *Proc Natl Acad Sci U S A* **91**, 7717-21.
- Carlberg, C. (1995).** Mechanisms of nuclear signalling by vitamin D3. Interplay with retinoid and thyroid hormone signalling. *Eur J Biochem* **231**, 517-27.
- Chamovitz, D. A., and Glickman, M. (2002).** The COP9 signalosome. *Curr Biol* **12**, R232.
- Chamovitz, D. A., Wei, N., Osterlund, M. T., von Arnim, A. G., Staub, J. M., Matsui, M., and Deng, X. W. (1996).** The COP9 complex, a novel multisubunit nuclear regulator involved in light control of a plant developmental switch. *Cell* **86**, 115-21.
- Chen, J. D., and Evans, R. M. (1995).** A transcriptional co-repressor that interacts with nuclear hormone receptors. *Nature* **377**, 454-7.
- Chen, L. I., Nishinaka, T., Kwan, K., Kitabayashi, I., Yokoyama, K., Fu, Y. H., Grunwald, S., and Chiu, R. (1994).** The retinoblastoma gene product RB stimulates Sp1-mediated transcription by liberating Sp1 from a negative regulator. *Mol Cell Biol* **14**, 4380-9.
- Chen, Y. R., and Tan, T. H. (1998).** Inhibition of the c-Jun N-terminal kinase (JNK) signaling pathway by curcumin. *Oncogene* **17**, 173-8.
- Chomczynski, P., and Sacchi, N. (1987).** Single-step method of RNA isolation by acid guanidinium thiocyanate-phenol-chloroform extraction. *Anal Biochem* **162**, 156-9.
- Cichon, S., Anker, M., Vogt, I. R., Rohleder, H., Putzstuck, M., Hillmer, A., Farooq, S. A., Al-Dhafri, K. S., Ahmad, M., Haque, S., Rietschel, M., Propping, P., Kruse, R., and Nothen, M. M. (1998).** Cloning, genomic organization, alternative transcripts and mutational analysis of the gene responsible for autosomal recessive universal congenital alopecia. *Hum Mol Genet* **7**, 1671-9.
- Claret, F. X., Hibi, M., Dhut, S., Toda, T., and Karin, M. (1996).** A new group of conserved coactivators that increase the specificity of AP-1 transcription factors. *Nature* **383**, 453-7.
- Coso, O. A., Chiariello, M., Yu, J. C., Teramoto, H., Crespo, P., Xu, N., Miki, T., and Gutkind, J. S. (1995).** The small GTP-binding proteins Rac1 and Cdc42 regulate the activity of the JNK/SAPK signaling pathway. *Cell* **81**, 1137-46.
- Crawford, P. A., Dorn, C., Sadovsky, Y., and Milbrandt, J. (1998).** Nuclear receptor DAX-1 recruits nuclear receptor corepressor N-CoR to steroidogenic factor 1. *Mol Cell Biol* **18**, 2949-56.
- Cuadrado, A., Bernal, J., and Munoz, A. (1999).** Identification of the mammalian homolog of the splicing regulator Suppressor-of-white-apricot as a thyroid hormone regulated gene. *Brain Res Mol Brain Res* **71**, 332-40.
- Cuenda, A., and Dorow, D. S. (1998).** Differential activation of stress-activated protein kinase kinases SKK4/MKK7 and SKK1/MKK4 by the mixed-lineage kinase-2 and mitogen-activated protein kinase kinase (MKK) kinase-1. *Biochem J* **333**, 11-5.
- De Luca, P., Majello, B., and Lania, L. (1998).** Retinoblastoma protein tethered to promoter DNA represses TBP-mediated transcription. *J Cell Biochem* **70**, 281-7.
- Decesse, J. T., Medjkane, S., Datto, M. B., and Cremisi, C. E. (2001).** RB regulates transcription of the p21/WAF1/CIP1 gene. *Oncogene* **20**, 962-71.
- DeLong, G. R. (1990).** The effect of iodine deficiency on neuromuscular development. *IID Newslett* **6**, 1-12.

- Deng, X. W., Dubiel, W., Wei, N., Hofmann, K., Mundt, K., Colicelli, J., Kato, J., Naumann, M., Segal, D., Seeger, M., Carr, A., Glickman, M., and Chamovitz, D. A. (2000). Unified nomenclature for the COP9 signalosome and its subunits: an essential regulator of development. *Trends Genet* **16**, 202-3.
- Dickson, P. W., Aldred, A. R., Menting, J. G., Marley, P. D., Sawyer, W. H., and Schreiber, G. (1987). Thyroxine transport in choroid plexus. *J Biol Chem* **262**, 13907-15.
- Dignam, J. D., Lebovitz, R. M., and Roeder, R. G. (1983). Accurate transcription initiation by RNA polymerase II in a soluble extract from isolated mammalian nuclei. *Nucleic Acids Res* **11**, 1475-89.
- Dilworth, F. J., and Chambon, P. (2001). Nuclear receptors coordinate the activities of chromatin remodeling complexes and coactivators to facilitate initiation of transcription. *Oncogene* **20**, 3047-54.
- Donahue, R. A., and Bebee, R. L. (1999). *Focus* **21**, 49.
- Dorow, D. S., Devereux, L., Tu, G. F., Price, G., Nicholl, J. K., Sutherland, G. R., and Simpson, R. J. (1995). Complete nucleotide sequence, expression, and chromosomal localisation of human mixed-lineage kinase 2. *Eur J Biochem* **234**, 492-500.
- Dou, Q. P., Markell, P. J., and Pardee, A. B. (1992). Thymidine kinase transcription is regulated at G1/S phase by a complex that contains retinoblastoma-like protein and a cdc2 kinase. *Proc Natl Acad Sci U S A* **89**, 3256-60.
- Dressel, U., and Baniahmad, A. (2000). Thyroid hormone receptors. In "Nuclear receptors and genetic disease" (T. P. Burris and E. McCabe, Eds.), pp59-96. *Academic Press Ltd*.
- Dressel, U., Thormeyer, D., Altincicek, B., Paululat, A., Eggert, M., Schneider, S., Tenbaum, S. P., Renkawitz, R., and Baniahmad, A. (1999). Alien, a highly conserved protein with characteristics of a corepressor for members of the nuclear hormone receptor superfamily. *Mol Cell Biol* **19**, 3383-94.
- Dussault, J. H., and Ruel, J. (1987). Thyroid hormones and brain development. *Annu Rev Physiol* **49**, 321-34.
- Dyivedi, P. P., Muscat, G. E., Bailey, P. J., Omdahl, J. L., and May, B. K. (1998). Repression of basal transcription by vitamin D receptor: evidence for interaction of unliganded vitamin D receptor with two receptor interaction domains in RIP13delta1. *J Mol Endocrinol* **20**, 327-35.
- Dynan, W. S., and Tjian, R. (1983). The promoter-specific transcription factor Sp1 binds to upstream sequences in the SV40 early promoter. *Cell* **35**, 79-87.
- Dyson, N. (1998). The regulation of E2F by pRB-family proteins. *Genes Dev* **12**, 2245-62.
- Evan, G. I., Lewis, G. K., Ramsay, G., and Bishop, J. M. (1985). Isolation of monoclonal antibodies specific for human c-myc proto-oncogene product. *Mol Cell Biol* **5**, 3610-6.
- Feinberg, A. P., and Vogelstein, B. (1983). A technique for radiolabeling DNA restriction endonuclease fragments to high specific activity. *Anal Biochem* **132**, 6-13.
- Ferreiro, B., Pastor, R., and Bernal, J. (1990). T3 receptor occupancy and T3 levels in plasma and cytosol during rat brain development. *Acta Endocrinol (Copenh)* **123**, 95-9.
- Flemington, E. K., Speck, S. H., and Kaelin, W. G., Jr. (1993). E2F-1-mediated transactivation is inhibited by complex formation with the retinoblastoma susceptibility gene product. *Proc Natl Acad Sci U S A* **90**, 6914-8.

- Forrest, D., and Vennstrom, B. (2000). Functions of thyroid hormone receptors in mice. **Thyroid** **10**, 41-52.
- Freilich, S., Oron, E., Kapp, Y., Nevo-Caspi, Y., Orgad, S., Segal, D., and Chamovitz, D. A. (1999). The COP9 signalosome is essential for development of *Drosophila melanogaster*. **Curr Biol** **9**, 1187-90.
- Fu, H., Reis, N., Lee, Y., Glickman, M. H., and Vierstra, R. D. (2001). Subunit interaction maps for the regulatory particle of the 26S proteasome and the COP9 signalosome. **Embo J** **20**, 7096-107.
- Fu, Y. H., Nishinaka, T., Yokoyama, K., and Chiu, R. (1998). A retinoblastoma susceptibility gene product, RB, targeting protease is regulated through the cell cycle. **FEBS Lett** **421**, 89-93.
- Furukawa, Y., DeCaprio, J. A., Freedman, A., Kanakura, Y., Nakamura, M., Ernst, T. J., Livingston, D. M., and Griffin, J. D. (1990). Expression and state of phosphorylation of the retinoblastoma susceptibility gene product in cycling and noncycling human hematopoietic cells. **Proc Natl Acad Sci U S A** **87**, 2770-4.
- Galasinski, S. C., Resing, K. A., Goodrich, J. A., and Ahn, N. G. (2002). Phosphatase inhibition leads to histone deacetylase 1/2 phosphorylation and disruption of co-repressor interactions. **J Biol Chem** **277**, 27.
- Gall, C. M., and Isackson, P. J. (1989). Limbic seizures increase neuronal production of messenger RNA for nerve growth factor. **Science** **245**, 758-61.
- Gelmetti, V., Zhang, J., Fanelli, M., Minucci, S., Pelicci, P. G., and Lazar, M. A. (1998). Aberrant recruitment of the nuclear receptor corepressor-histone deacetylase complex by the acute myeloid leukemia fusion partner ETO. **Mol Cell Biol** **18**, 7185-91.
- Gerstel, B., Tuite, M. F., and McCarthy, J. E. (1992). The effects of 5'-capping, 3'-polyadenylation and leader composition upon the translation and stability of mRNA in a cell-free extract derived from the yeast *Saccharomyces cerevisiae*. **Mol Microbiol** **6**, 2339-48.
- Goldsmith, E. J., and Cobb, M. H. (1994). Protein kinases. **Curr Opin Struct Biol** **4**, 833-40.
- Golemis, E. A., and Brent, R. (1992). Fused protein domains inhibit DNA binding by LexA. **Mol Cell Biol** **12**, 3006-14.
- Goodfellow, P. N., and Camerino, G. (2001). DAX-1, an "antitesticis" gene. **Exs** , 57-69.
- Goubeaud, A., Knirr, S., Renkawitz-Pohl, R., and Paululat, A. (1996). The *Drosophila* gene alien is expressed in the muscle attachment sites during embryogenesis and encodes a protein highly conserved between plants, *Drosophila* and vertebrates. **Mech Dev** **57**, 59-68.
- Graham, F. L., and van der Eb, A. J. (1973). A new technique for the assay of infectivity of human adenovirus 5 DNA. **Virology** **52**, 456-67.
- Gu, W., Schneider, J. W., Condorelli, G., Kaushal, S., Mahdavi, V., and Nadal-Ginard, B. (1993). Interaction of myogenic factors and the retinoblastoma protein mediates muscle cell commitment and differentiation. **Cell** **72**, 309-24.
- Guhaniyogi, J., and Brewer, G. (2001). Regulation of mRNA stability in mammalian cells. **Gene** **265**, 11-23.
- Guo, W., Burris, T. P., and McCabe, E. R. (1995). Expression of DAX-1, the gene responsible for X-linked adrenal hypoplasia congenita and hypogonadotropic hypogonadism, in the hypothalamic-pituitary-adrenal/gonadal axis. **Biochem Mol Med** **56**, 8-13.

- Hansen, C. M., Binderup, L., Hamberg, K. J., and Carlberg, C. (2001). Vitamin D and cancer: effects of 1,25(OH)<sub>2</sub>D<sub>3</sub> and its analogs on growth control and tumorigenesis. *Front Biosci* **6**, D820-48.
- Harbour, J. W., and Dean, D. C. (2000a). The Rb/E2F pathway: expanding roles and emerging paradigms. *Genes Dev* **14**, 2393-409.
- Harbour, J. W., and Dean, D. C. (2000b). Rb function in cell-cycle regulation and apoptosis. *Nat Cell Biol* **2**, E65-7.
- Harper, J. W. (2001). Protein destruction: adapting roles for Cks proteins. *Curr Biol* **11**, R431-5.
- Hatten, M. E., and Heintz, N. (1995). Mechanisms of neural patterning and specification in the developing cerebellum. *Annu Rev Neurosci* **18**, 385-408.
- Hayashi, S., and Yamaguchi, M. (1999). Kinase-independent activity of Cdc2/cyclin A prevents the S phase in the Drosophila cell cycle. *Genes Cells* **4**, 111-22.
- Heinzel, T., Lavinsky, R. M., Mullen, T. M., Soderstrom, M., Laherty, C. D., Torchia, J., Yang, W. M., Brard, G., Ngo, S. D., Davie, J. R., Seto, E., Eisenman, R. N., Rose, D. W., Glass, C. K., and Rosenfeld, M. G. (1997). A complex containing N-CoR, mSin3 and histone deacetylase mediates transcriptional repression. *Nature* **387**, 43-8.
- Henke, W., Ferrell, K., Bech-Otschir, D., Seeger, M., Schade, R., Jungblut, P., Naumann, M., and Dubiel, W. (1999). Comparison of human COP9 signalsome and 26S proteasome lid'. *Mol Biol Rep* **26**, 29-34.
- Hermanson, O., Glass, C. K., and Rosenfeld, M. G. (2002). Nuclear receptor coregulators: multiple modes of modification. *Trends Endocrinol Metab* **13**, 55-60.
- Hirai, S., Katoh, M., Terada, M., Kyriakis, J. M., Zon, L. I., Rana, A., Avruch, J., and Ohno, S. (1997). MST/MLK2, a member of the mixed lineage kinase family, directly phosphorylates and activates SEK1, an activator of c-Jun N-terminal kinase/stress-activated protein kinase. *J Biol Chem* **272**, 15167-73.
- Hirai, S., Noda, K., Moriguchi, T., Nishida, E., Yamashita, A., Deyama, T., Fukuyama, K., and Ohno, S. (1998). Differential activation of two JNK activators, MKK7 and SEK1, by MKN28-derived nonreceptor serine/threonine kinase/mixed lineage kinase 2. *J Biol Chem* **273**, 7406-12.
- Hofmann, K., and Bucher, P. (1998). The PCI domain: a common theme in three multiprotein complexes. *Trends Biochem Sci* **23**, 204-5.
- Holter, E., Kotaja, N., Makela, S., Strauss, L., Kietz, S., Janne, O. A., Gustafsson, J. A., Palvimo, J. J., and Treuter, E. (2002). Inhibition of Androgen Receptor (AR) Function by the Reproductive Orphan Nuclear Receptor DAX-1. *Mol Endocrinol* **16**, 515-28.
- Horlein, A. J., Naar, A. M., Heinzel, T., Torchia, J., Gloss, B., Kurokawa, R., Ryan, A., Kamei, Y., Soderstrom, M., Glass, C. K., and et al. (1995). Ligand-independent repression by the thyroid hormone receptor mediated by a nuclear receptor co-repressor. *Nature* **377**, 397-404.
- Hunter, T. (2000). Signaling--2000 and beyond. *Cell* **100**, 113-27.
- Iglesias, T., Llanos, S., Lopez-Barahona, M., Perez-Aranda, A., Rodriguez-Pena, A., Bernal, J., Hohne, A., Seliger, B., and Munoz, A. (1994). c-erbA and v-erbA modulate growth and gene expression of a mouse glial precursor cell line. *Cell Growth Differ* **5**, 697-704.
- Ito, M., Yu, R., and Jameson, J. L. (1997). DAX-1 inhibits SF-1-mediated transactivation via a carboxy-terminal domain that is deleted in adrenal hypoplasia congenita. *Mol Cell Biol* **17**, 1476-83.

- Jochum, W., Passegue, E., and Wagner, E. F. (2001).** AP-1 in mouse development and tumorigenesis. *Oncogene* **20**, 2401-12.
- John, P. C., Mews, M., and Moore, R. (2001).** Cyclin/Cdk complexes: their involvement in cell cycle progression and mitotic division. *Protoplasma* **216**, 119-42.
- Johnson-Pais, T., Degin, C., and Thayer, M. J. (2001).** pRB induces Sp1 activity by relieving inhibition mediated by MDM2. *Proc Natl Acad Sci U S A* **98**, 2211-6.
- Johnsten, R. J. (1994).** "Molecular Genetics of Yeast. A practical approach. Department of Bioscience and Biotechnology, Glasgow." Oxford University Press, Oxford.
- Kapelari, B., Bech-Otschir, D., Hegerl, R., Schade, R., Dumdey, R., and Dubiel, W. (2000).** Electron microscopy and subunit-subunit interaction studies reveal a first architecture of COP9 signalosome. *J Mol Biol* **300**, 1169-78.
- Karin, M., and Hunter, T. (1995).** Transcriptional control by protein phosphorylation: signal transmission from the cell surface to the nucleus. *Curr Biol* **5**, 747-57.
- Karniol, B., and Chamovitz, D. A. (2000).** The COP9 signalosome: from light signaling to general developmental regulation and back. *Curr Opin Plant Biol* **3**, 387-93.
- Kato, S. (2000).** The function of vitamin D receptor in vitamin D action. *J Biochem (Tokyo)* **127**, 717-22.
- Kaye, F. J., Kratzke, R. A., Gerster, J. L., and Horowitz, J. M. (1990).** A single amino acid substitution results in a retinoblastoma protein defective in phosphorylation and oncoprotein binding. *Proc Natl Acad Sci U S A* **87**, 6922-6.
- Kim, S. J., Lee, H. D., Robbins, P. D., Busam, K., Sporn, M. B., and Roberts, A. B. (1991).** Regulation of transforming growth factor beta 1 gene expression by the product of the retinoblastoma-susceptibility gene. *Proc Natl Acad Sci U S A* **88**, 3052-6.
- Kim, S. J., Onwuta, U. S., Lee, Y. I., Li, R., Botchan, M. R., and Robbins, P. D. (1992a).** The retinoblastoma gene product regulates Sp1-mediated transcription. *Mol Cell Biol* **12**, 2455-63.
- Kim, S. J., Wagner, S., Liu, F., O'Reilly, M. A., Robbins, P. D., and Green, M. R. (1992b).** Retinoblastoma gene product activates expression of the human TGF-beta 2 gene through transcription factor ATF-2. *Nature* **358**, 331-4.
- Kim, T., Hofmann, K., von Arnim, A. G., and Chamovitz, D. A. (2001).** PCI complexes: pretty complex interactions in diverse signaling pathways. *Trends Plant Sci* **6**, 379-86.
- Klebe, R. J., Chen, T., and Ruddle, F. H. (1970).** Controlled production of proliferating somatic cell hybrids. *J Cell Biol* **45**, 74-82.
- Klenova, E. M., Nicolas, R. H., Paterson, H. F., Carne, A. F., Heath, C. M., Goodwin, G. H., Neiman, P. E., and Lobanekov, V. V. (1993).** CTCF, a conserved nuclear factor required for optimal transcriptional activity of the chicken c-myc gene, is an 11-Zn-finger protein differentially expressed in multiple forms. *Mol Cell Biol* **13**, 7612-24.
- Koziczak, M., Krek, W., and Nagamine, Y. (2000).** Pocket protein-independent repression of urokinase-type plasminogen activator and plasminogen activator inhibitor 1 gene expression by E2F1. *Mol Cell Biol* **20**, 2014-22.
- Krek, W., and DeCaprio, J. A. (1995).** Cell Synchronization. In "Methods in Enzymology", Vol. 254. Academic Press.

- Laemmli, U. K. (1970).** Cleavage of structural proteins during the assembly of the head of bacteriophage T4. *Nature* **227**, 680-5.
- Laherty, C. D., Yang, W. M., Sun, J. M., Davie, J. R., Seto, E., and Eisenman, R. N. (1997).** Histone deacetylases associated with the mSin3 corepressor mediate mad transcriptional repression. *Cell* **89**, 349-56.
- Lai, A., Lee, J. M., Yang, W. M., DeCaprio, J. A., Kaelin, W. G., Jr., Seto, E., and Branton, P. E. (1999a).** RBP1 recruits both histone deacetylase-dependent and -independent repression activities to retinoblastoma family proteins. *Mol Cell Biol* **19**, 6632-41.
- Lalli, E., Bardoni, B., Zazopoulos, E., Wurtz, J. M., Strom, T. M., Moras, D., and Sassone-Corsi, P. (1997).** A transcriptional silencing domain in DAX-1 whose mutation causes adrenal hypoplasia congenita. *Mol Endocrinol* **11**, 1950-60.
- Lania, L., Majello, B., and De Luca, P. (1997).** Transcriptional regulation by the Sp family proteins. *Int J Biochem Cell Biol* **29**, 1313-23.
- Lebel, J. M., Dussault, J. H., and Puymirat, J. (1994).** Overexpression of the beta 1 thyroid receptor induces differentiation in neuro-2a cells. *Proc Natl Acad Sci U S A* **91**, 2644-8.
- Lee, J. W., Choi, H. S., Gyuris, J., Brent, R., and Moore, D. D. (1995).** Two classes of proteins dependent on either the presence or absence of thyroid hormone for interaction with the thyroid hormone receptor. *Mol Endocrinol* **9**, 243-54.
- Lee, J. W., Lee, Y. C., Na, S. Y., Jung, D. J., and Lee, S. K. (2001).** Transcriptional coregulators of the nuclear receptor superfamily: coactivators and corepressors. *Cell Mol Life Sci* **58**, 289-97.
- Lees, E. (1995).** Cyclin dependent kinase regulation. *Curr Opin Cell Biol* **7**, 773-80.
- Legrand, J. (1984).** Effects of thyroid hormones on central nervous system development. In "Neurobehavioural Teratology" (J. E. E. Yanai, Ed.), pp. 331-363. Elsevier Science Publishers, Amsterdam.
- Lew, D. J., and Kornbluth, S. (1996).** Regulatory roles of cyclin dependent kinase phosphorylation in cell cycle control. *Curr Opin Cell Biol* **8**, 795-804.
- Li, H., and Wicks, W. D. (2001).** Retinoblastoma protein interacts with ATF2 and JNK/p38 in stimulating the transforming growth factor-beta2 promoter. *Arch Biochem Biophys* **394**, 1-12.
- Li, Q., Sachs, L., Shi, Y. B., and Wolffe, A. P. (1999).** Modification of Chromatin Structure by the Thyroid Hormone Receptor. *Trends Endocrinol Metab* **10**, 157-164.
- Lindeman, G. J., Gaubatz, S., Livingston, D. M., and Ginsberg, D. (1997).** The subcellular localization of E2F-4 is cell-cycle dependent. *Proc Natl Acad Sci U S A* **94**, 5095-100.
- Luo, R. X., Postigo, A. A., and Dean, D. C. (1998).** Rb interacts with histone deacetylase to repress transcription. *Cell* **92**, 463-73.
- Lutterbach, B., Westendorf, J. J., Linggi, B., Patten, A., Moniwa, M., Davie, J. R., Huynh, K. D., Bardwell, V. J., Lavinsky, R. M., Rosenfeld, M. G., Glass, C., Seto, E., and Hiebert, S. W. (1998).** ETO, a target of t(8;21) in acute leukemia, interacts with the N-CoR and mSin3 corepressors. *Mol Cell Biol* **18**, 7176-84.
- Lyapina, S., Cope, G., Shevchenko, A., Serino, G., Tsuge, T., Zhou, C., Wolf, D. A., Wei, N., and Deshaies, R. J. (2001).** Promotion of NEDD-CUL1 conjugate cleavage by COP9 signalosome. *Science* **292**, 1382-5.

- Mahalingam, S., Ayyavoo, V., Patel, M., Kieber-Emmons, T., Kao, G. D., Muschel, R. J., and Weiner, D. B. (1998). HIV-1 Vpr interacts with a human 34-kDa mov34 homologue, a cellular factor linked to the G2/M phase transition of the mammalian cell cycle. *Proc Natl Acad Sci U S A* **95**, 3419-24.
- Mangelsdorf, D. J., Thummel, C., Beato, M., Herrlich, P., Schutz, G., Umesono, K., Blumberg, B., Kastner, P., Mark, M., Chambon, P., and et al. (1995). The nuclear receptor superfamily: the second decade. *Cell* **83**, 835-9.
- McKenna, N. J., and O'Malley, B. W. (2000). From ligand to response: generating diversity in nuclear receptor coregulator function. *J Steroid Biochem Mol Biol* **74**, 351-6.
- Mellstrom, B., Naranjo, J. R., Santos, A., Gonzalez, A. M., and Bernal, J. (1991). Independent expression of the alpha and beta c-erbA genes in developing rat brain. *Mol Endocrinol* **5**, 1339-50.
- Meloni, A. R., Smith, E. J., and Nevins, J. R. (1999). A mechanism for Rb/p130-mediated transcription repression involving recruitment of the CtBP corepressor. *Proc Natl Acad Sci U S A* **96**, 9574-9.
- Morgan, J. I., and Curran, T. (1995). Immediate-early genes: ten years on. *Trends Neurosci* **2**, 66-7.
- Morreale de Escobar, G., Pastor, R., Obregon, M. J., and Escobar del Rey, F. (1985). Effects of maternal hypothyroidism on the weight and thyroid hormone content of rat embryonic tissues, before and after onset of fetal thyroid function. *Endocrinology* **117**, 1890-900.
- Morris, E. J., and Dyson, N. J. (2001). Retinoblastoma protein partners. *Adv Cancer Res* **82**, 1-54.
- Morte, B., Manzano, J., Scanlan, T. S., Vennström, B., and Bernal, J. (2002). Deletion of the thyroid hormone receptor alpha1 prevents the alterations of the cerebellum induced by hypothyroidism. *Proc. Natl. Acad. Sci. USA* in press.
- Muller, H., Lukas, J., Schneider, A., Warthoe, P., Bartek, J., Eilers, M., and Strauss, M. (1994). Cyclin D1 expression is regulated by the retinoblastoma protein. *Proc Natl Acad Sci U S A* **91**, 2945-9.
- Mundt, K. E., Porte, J., Murray, J. M., Brikos, C., Christensen, P. U., Caspari, T., Hagan, I. M., Millar, J. B., Simanis, V., Hofmann, K., and Carr, A. M. (1999). The COP9/signalosome complex is conserved in fission yeast and has a role in S phase. *Curr Biol* **9**, 1427-30.
- Muñoz, A., Rodriguez-Peña, A., Perez-Castillo, A., Ferreiro, B., Sutcliffe, J. G., and Bernal, J. (1991). Effects of neonatal hypothyroidism on rat brain gene expression. *Mol Endocrinol* **5**, 273-80.
- Murphy, D. J., Hardy, S., and Engel, D. A. (1999). Human SWI-SNF component BRG1 represses transcription of the c-fos gene. *Mol Cell Biol* **19**, 2724-33.
- Muscat, G. E., Burke, L. J., and Downes, M. (1998). The corepressor N-CoR and its variants RIP13a and RIP13Delta1 directly interact with the basal transcription factors TFIIB, TAFII32 and TAFII70. *Nucleic Acids Res* **26**, 2899-907.
- Muscatelli, F., Strom, T. M., Walker, A. P., Zanaria, E., Recan, D., Meindl, A., Bardoni, B., Guioli, S., Zehetner, G., Rabl, W., and et al. (1994). Mutations in the DAX-1 gene give rise to both X-linked adrenal hypoplasia congenita and hypogonadotropic hypogonadism. *Nature* **372**, 672-6.
- Nachtigal, M. W., Hirokawa, Y., Enyeart-VanHouten, D. L., Flanagan, J. N., Hammer, G. D., and Ingraham, H. A. (1998). Wilms' tumor 1 and Dax-1 modulate the orphan nuclear receptor SF-1 in sex-specific gene expression. *Cell* **93**, 445-54.



- Nagata, K., Puls, A., Futter, C., Aspenstrom, P., Schaefer, E., Nakata, T., Hirokawa, N., and Hall, A. (1998).** The MAP kinase kinase kinase MLK2 co-localizes with activated JNK along microtubules and associates with kinesin superfamily motor KIF3. **Embo J** **17**, 149-58.
- Nagy, L., Kao, H. Y., Chakravarti, D., Lin, R. J., Hassig, C. A., Ayer, D. E., Schreiber, S. L., and Evans, R. M. (1997).** Nuclear receptor repression mediated by a complex containing SMRT, mSin3A, and histone deacetylase. **Cell** **89**, 373-80.
- Naumann, M., Bech-Otschir, D., Huang, X., Ferrell, K., and Dubiel, W. (1999).** COP9 signalosome-directed c-Jun activation/stabilization is independent of JNK. **J Biol Chem** **274**, 35297-300.
- Nelson, P. J., and Daniel, T. O. (2002).** Emerging targets: Molecular mechanisms of cell contact-mediated growth control. **Kidney Int** **61**, 99-105.
- Nicholson, J. L., and Altman, J. (1972).** The effects of early hypo- and hyperthyroidism on the development of rat cerebellar cortex. I. Cell proliferation and differentiation. **Brain Res** **44**, 13-23.
- Nishinaka, T., Fu, Y. H., Chen, L. I., Yokoyama, K., and Chiu, R. (1997).** A unique cathepsin-like protease isolated from CV-1 cells is involved in rapid degradation of retinoblastoma susceptibility gene product, RB, and transcription factor SP1. **Biochim Biophys Acta** **1351**, 274-86.
- Noe, V., Chen, C., Alemany, C., Nicolas, M., Caragol, I., Chasin, L. A., and Ciudad, C. J. (1997).** Cell-growth regulation of the hamster dihydrofolate reductase gene promoter by transcription factor Sp1. **Eur J Biochem** **249**, 13-20.
- Norman, C., Runswick, M., Pollock, R., and Treisman, R. (1988).** Isolation and properties of cDNA clones encoding SRF, a transcription factor that binds to the c-fos serum response element. **Cell** **55**, 989-1003.
- Oppenheimer, J. H., and Schwartz, H. L. (1997).** Molecular basis of thyroid hormone-dependent brain development. **Endocr Rev** **18**, 462-75.
- Ordentlich, P., Downes, M., and Evans, R. M. (2001).** Corepressors and nuclear hormone receptor function. **Curr Top Microbiol Immunol** **254**, 101-16.
- Patel, M. V., McKay, I. A., and Burrin, J. M. (2001).** Transcriptional regulators of steroidogenesis, DAX-1 and SF-1, are expressed in human skin. **J Invest Dermatol** **117**, 1559-65.
- Perez-Juste, G., and Aranda, A. (1999).** The cyclin-dependent kinase inhibitor p27(Kip1) is involved in thyroid hormone-mediated neuronal differentiation. **J Biol Chem** **274**, 5026-31.
- Pollard, K. M., Chan, E. K., Grant, B. J., Sullivan, K. F., Tan, E. M., and Glass, C. A. (1990).** In vitro posttranslational modification of lamin B cloned from a human T-cell line. **Mol Cell Biol** **10**, 2164-75.
- Pollmann, C., Huang, X., Mall, J., Bech-Otschir, D., Naumann, M., and Dubiel, W. (2001).** The constitutive photomorphogenesis 9 signalosome directs vascular endothelial growth factor production in tumor cells. **Cancer Res** **61**, 8416-21.
- Polly, P., Herdick, M., Moehren, U., Baniahmad, A., Heinzl, T., and Carlberg, C. (2000).** VDR-Alien: a novel, DNA-selective vitamin D(3) receptor-corepressor partnership. **Faseb J** **14**, 1455-63.
- Porterfield, S. P., and Hendrich, C. E. (1993).** The role of thyroid hormones in prenatal and neonatal neurological development—current perspectives. **Endocr Rev** **14**, 94-106.

- Potter, G. B., Beaudoin, G. M., 3rd, DeRenzo, C. L., Zarach, J. M., Chen, S. H., and Thompson, C. C. (2001). The hairless gene mutated in congenital hair loss disorders encodes a novel nuclear receptor corepressor. *Genes Dev* **15**, 2687-701.
- Rakic, P. (1972). Extrinsic cytological determinants of basket and stellate cell dendritic pattern in the cerebellar molecular layer. *J Comp Neurol* **146**, 335-54.
- Rodriguez-Pascual, F., Hausding, M., Ihrig-Biedert, I., Furneaux, H., Levy, A. P., Forstermann, U., and Kleinert, H. (2000). Complex contribution of the 3'-untranslated region to the expressional regulation of the human inducible nitric-oxide synthase gene. Involvement of the RNA-binding protein HuR. *J Biol Chem* **275**, 26040-9.
- Rodriguez-Peña, A., Ibarrola, N., Iniguez, M. A., Munoz, A., and Bernal, J. (1993). Neonatal hypothyroidism affects the timely expression of myelin-associated glycoprotein in the rat brain. *J Clin Invest* **91**, 812-8.
- Rosenfeld, M. G., and Glass, C. K. (2001). Coregulator codes of transcriptional regulation by nuclear receptors. *J Biol Chem* **276**, 36865-8.
- Sadowski, I., and Ptashne, M. (1989). A vector for expressing GAL4(1-147) fusions in mammalian cells. *Nucleic Acids Res* **17**, 7539.
- Sambrook, J., Fritsch, E. F., Maniatis, T. (1989). "Molecular Cloning: A Laboratory Manual, 2nd Ed." Cold Spring Harbor Laboratory, Cold Spring Harbor, New York.
- Schaefer, L., Beermann, M. L., and Miller, J. B. (1999). Coding sequence, genomic organization, chromosomal localization, and expression pattern of the signalosome component Cops2: the mouse homologue of *Drosophila* alien. *Genomics* **56**, 310-6.
- Scheffner, M., Munger, K., Byrne, J. C., and Howley, P. M. (1991). The state of the p53 and retinoblastoma genes in human cervical carcinoma cell lines. *Proc Natl Acad Sci U S A* **88**, 5523-7.
- Schwartz, M. A., and Assoian, R. K. (2001). Integrins and cell proliferation: regulation of cyclin-dependent kinases via cytoplasmic signaling pathways. *J Cell Sci* **114**, 2553-60.
- Schwechheimer, C., and Deng, X. W. (2001a). COP9 signalosome revisited: a novel mediator of protein degradation. *Trends Cell Biol* **11**, 420-6.
- Schwechheimer, C., Serino, G., Callis, J., Crosby, W. L., Lyapina, S., Deshaies, R. J., Gray, W. M., Estelle, M., and Deng, X. W. (2001b). Interactions of the COP9 signalosome with the E3 ubiquitin ligase SCFTIR1 in mediating auxin response. *Science* **292**, 1379-82.
- Seeger, M., Gordon, C., and Dubiel, W. (2001). Protein stability: The COP9 signalosome gets in on the act. *Curr Biol* **11**, R643-6.
- Seeger, M., Kraft, R., Ferrell, K., Bech-Otschir, D., Dumdey, R., Schade, R., Gordon, C., Naumann, M., and Dubiel, W. (1998). A novel protein complex involved in signal transduction possessing similarities to 26S proteasome subunits. *Faseb J* **12**, 469-78.
- Sellers, W. R., Rodgers, J. W., and Kaelin, W. G., Jr. (1995). A potent transrepression domain in the retinoblastoma protein induces a cell cycle arrest when bound to E2F sites. *Proc Natl Acad Sci U S A* **92**, 11544-8.
- Shaulian, E., and Karin, M. (2001). AP-1 in cell proliferation and survival. *Oncogene* **20**, 2390-400.
- Shen, W. J., Kim, H. S., and Tsai, S. Y. (1995). Stimulation of human insulin receptor gene expression by retinoblastoma gene product. *J Biol Chem* **270**, 20525-9.

- Siebert, J. L., and Robbins, P. D. (1999).** Rb inhibits the intrinsic kinase activity of TATA-binding protein-associated factor TAFII250. *Mol Cell Biol* **19**, 846-54.
- Sohm, F., Gaiddon, C., Antoine, M., Boutillier, A. L., and Loeffler, J. P. (1999).** The retinoblastoma susceptibility gene product/Sp1 signalling pathway is modulated by Ca<sup>2+</sup>/calmodulin kinases II and IV activity. *Oncogene* **18**, 2762-9.
- Spain, B. H., Bowdish, K. S., Pacal, A. R., Staub, S. F., Koo, D., Chang, C. Y., Xie, W., and Colicelli, J. (1996).** Two human cDNAs, including a homolog of Arabidopsis FUS6 (COP11), suppress G-protein- and mitogen-activated protein kinase-mediated signal transduction in yeast and mammalian cells. *Mol Cell Biol* **16**, 6698-706.
- Staton, J. M., Thomson, A. M., and Leedman, P. J. (2000).** Hormonal regulation of mRNA stability and RNA-protein interactions in the pituitary. *J Mol Endocrinol* **25**, 17-34.
- Swain, A., Narvaez, V., Burgoyne, P., Camerino, G., and Lovell-Badge, R. (1998).** Dax1 antagonizes Sry action in mammalian sex determination. *Nature* **391**, 761-7.
- Swanson, L. W. (1992).** "Brain Maps: Structure of the Rat Brain." Elsevier Science Publishers B. V., Amsterdam.
- Tagami, T., Lutz, W. H., Kumar, R., and Jameson, J. L. (1998).** The interaction of the vitamin D receptor with nuclear receptor corepressors and coactivators. *Biochem Biophys Res Commun* **253**, 358-63.
- Taieb, F., Karaiskou, A., Rime, H., and Jessus, C. (1998).** Human retinoblastoma protein (Rb) is phosphorylated by cdc2 kinase and MAP kinase in *Xenopus* maturing oocytes. *FEBS Lett* **425**, 465-71.
- Tenbaum, S. P., Juenemann, S., Schlitt, T., Bernal, J., Renkawitz, R., Muñoz, A., and Baniahmad, A. (submitted).** Alien/CSN2 gene expression is regulated by thyroid hormone in rat brain. .
- Tenbaum, S., and Baniahmad, A. (1997).** Nuclear receptors: structure, function and involvement in disease. *Int J Biochem Cell Biol* **29**, 1325-41.
- Thompson, C. C. (1996).** Thyroid hormone-responsive genes in developing cerebellum include a novel synaptotagmin and a hairless homolog. *J Neurosci* **16**, 7832-40.
- Thompson, C. C., and Bottcher, M. C. (1997).** The product of a thyroid hormone-responsive gene interacts with thyroid hormone receptors. *Proc Natl Acad Sci U S A* **94**, 8527-32.
- Tokitou, F., Nomura, T., Khan, M. M., Kaul, S. C., Wadhwa, R., Yasukawa, T., Kohno, I., and Ishii, S. (1999).** Viral ski inhibits retinoblastoma protein (Rb)-mediated transcriptional repression in a dominant negative fashion. *J Biol Chem* **274**, 4485-8.
- Tomoda, K., Kubota, Y., and Kato, J. (1999).** Degradation of the cyclin-dependent-kinase inhibitor p27Kip1 is instigated by Jab1. *Nature* **398**, 160-5.
- Tomoda, K., Kubota, Y., Arata, Y., Mori, S., Maeda, M., Tanaka, T., Yoshida, M., Yoneda-Kato, N., and Kato, J. Y. (2002).** The cytoplasmic shuttling and subsequent degradation of p27Kip1 mediated by Jab1/CSN5 and the COP9 signalosome complex. *J Biol Chem* **277**, 2302-10.
- Tsuge, T., Matsui, M., and Wei, N. (2001).** The subunit 1 of the COP9 signalosome suppresses gene expression through its N-terminal domain and incorporates into the complex through the PCI domain. *J Mol Biol* **305**, 1-9.

- Udvardia, A. J., Rogers, K. T., and Horowitz, J. M. (1992). A common set of nuclear factors bind to promoter elements regulated by the retinoblastoma protein. *Cell Growth Differ* **3**, 597-608.
- Udvardia, A. J., Rogers, K. T., Higgins, P. D., Murata, Y., Martin, K. H., Humphrey, P. A., and Horowitz, J. M. (1993). Sp-1 binds promoter elements regulated by the RB protein and Sp-1-mediated transcription is stimulated by RB coexpression. *Proc Natl Acad Sci U S A* **90**, 3265-9.
- Udvardia, A. J., Templeton, D. J., and Horowitz, J. M. (1995). Functional interactions between the retinoblastoma (Rb) protein and Sp-family members: superactivation by Rb requires amino acids necessary for growth suppression. *Proc Natl Acad Sci U S A* **92**, 3953-7.
- van Wijnen, A. J., van Gurp, M. F., de Ridder, M. C., Tufarelli, C., Last, T. J., Birnbaum, M., Vaughan, P. S., Giordano, A., Krek, W., Neufeld, E. J., Stein, J. L., and Stein, G. S. (1996). CDP/cut is the DNA-binding subunit of histone gene transcription factor HiNF-D: a mechanism for gene regulation at the G1/S phase cell cycle transition point independent of transcription factor E2F. *Proc Natl Acad Sci U S A* **93**, 11516-21.
- Vreken, P., Buddelmeijer, N., and Raue, H. A. (1992). A cell-free extract from yeast cells for studying mRNA turnover. *Nucleic Acids Res* **20**, 2503-10.
- Wang, C., Fu, M., Mani, S., Wadler, S., Senderowicz, A. M., and Pestell, R. G. (2001). Histone acetylation and the cell-cycle in cancer. *Front Biosci* **6**, D610-29.
- Wei, N., and Deng, X. W. (1999). Making sense of the COP9 signalosome. A regulatory protein complex conserved from Arabidopsis to human. *Trends Genet* **15**, 98-103.
- Weintraub, S. J., Chow, K. N., Luo, R. X., Zhang, S. H., He, S., and Dean, D. C. (1995). Mechanism of active transcriptional repression by the retinoblastoma protein. *Nature* **375**, 812-5.
- Wolffe, A. P., Collingwood, T. N., Li, Q., Yee, J., Urnov, F., and Shi, Y. B. (2000b). Thyroid hormone receptor, v-ErbA, and chromatin. *Vitam Horm* **58**, 449-92.
- Wolffe, A. P., Urnov, F. D., and Guschin, D. (2000a). Co-repressor complexes and remodelling chromatin for repression. *Biochem Soc Trans* **28**, 379-86.
- Yamabe, Y., Shimamoto, A., Goto, M., Yokota, J., Sugawara, M., and Furuichi, Y. (1998). Sp1-mediated transcription of the Werner helicase gene is modulated by Rb and p53. *Mol Cell Biol* **18**, 6191-200.
- Yamasaki, L. (1998). Growth regulation by the E2F and DP transcription factor families. In "Cell cycle control" (M. Pagano, Ed.), pp. 199-227. Springer, New York, NY.
- Yang, X., Menon, S., Lykke-Andersen, K., Tsuge, T., Di, X., Wang, X., Rodriguez-Suarez, R. J., Zhang, H., and Wei, N. (2002). The COP9 Signalosome Inhibits p27(kip1) Degradation and Impedes G1-S Phase Progression via Deneddylation of SCF Cul1. *Curr Biol* **12**, 667-72.
- Yang-Yen, H. F., Chiu, R., and Karin, M. (1990). Elevation of AP1 activity during F9 cell differentiation is due to increased c-jun transcription. *New Biol* **2**, 351-61.
- Yee, A. S., Shih, H. H., and Tevosian, S. G. (1998). New perspectives on retinoblastoma family functions in differentiation. *Front Biosci* **3**, D532-47.
- Zamir, I., Dawson, J., Lavinsky, R. M., Glass, C. K., Rosenfeld, M. G., and Lazar, M. A. (1997). Cloning and characterization of a corepressor and potential component of the nuclear hormone receptor repression complex. *Proc Natl Acad Sci U S A* **94**, 14400-5.

- 
- Zanaria, E., Muscatelli, F., Bardoni, B., Strom, T. M., Guioli, S., Guo, W., Lalli, E., Moser, C., Walker, A. P., McCabe, E. R., and et al. (1994).** An unusual member of the nuclear hormone receptor superfamily responsible for X-linked adrenal hypoplasia congenita. *Nature* **372**, 635-41.
- Zazopoulos, E., Lalli, E., Stocco, D. M., and Sassone-Corsi, P. (1997).** DNA binding and transcriptional repression by DAX-1 blocks steroidogenesis. *Nature* **390**, 311-5.
- Zhang, H. S., Gavin, M., Dahiya, A., Postigo, A. A., Ma, D., Luo, R. X., Harbour, J. W., and Dean, D. C. (2000).** Exit from G1 and S phase of the cell cycle is regulated by repressor complexes containing HDAC-Rb-hSWI/SNF and Rb-hSWI/SNF. *Cell* **101**, 79-89.
- Zhou, C., Seibert, V., Geyer, R., Rhee, E., Lyapina, S., Cope, G., Deshaies, R. J., and Wolf, D. A. (2001).** The fission yeast COP9/signalosome is involved in cullin modification by ubiquitin-related Ned8p. *BMC Biochem* **2**, 7.

### Eidesstattliche Erklärung

Hiermit versichere ich, an Eides statt, daß ich die vorliegende Arbeit selbstständig verfaßt und keine unzulässigen, oder nicht angegebenen, Hilfsmittel benutzt habe.

Madrid, den

Stephan Tenbaum

## Curriculum Vitae

Stephan Paul Tenbaum

**Date of birth:** May 13<sup>th</sup>, 1969

**Place of birth:** Siegen, Germany  
**Address of work:** Instituto de Investigaciones Biomédicas “Alberto Sols”  
 CSIC/UAM  
 C/ Arturo Duperier, 4  
 28029 Madrid, Spain

**Home address:** C/Oslo, 38; 2<sup>o</sup>A  
 28022 Madrid, Spain

**Citizenship:** German

**Family status:** Single

**Education:**

Since Sept. 1997	PhD Thesis at the Laboratory of Prof. Dr. Alberto Muñoz, Instituto de Investigaciones Biomédicas, Madrid, Spain.
Sept. 1996 - Aug. 1997	Continuing projects at the Genetic Institute, Giessen, Germany
June 1995 - Aug. 1996	Diploma Thesis at the Genetic Institute, Justus-Liebig-University, Giessen, Germany Project leader: Prof. Dr. Rainer Renkawitz Group leader: Dr. Aria Baniahmad Title of Diploma thesis: <i>Functional characterization of eukaryotic transcriptional silencers - repression domains and involvement of co-repressors in their silencing mechanisms.</i> (grade: excellent)
April 1995	"Diploma for Biology" (grade: excellent)
Sept. 1992 - March 1995	Main- and specialization courses on the disciplines: Genetics, microbiology, animal-physiology and pharmacology
Sept. 1992	"Prediploma examination" (grade: excellent)
Sept. 1989 - April 1992	Study of Biology at the Justus-Liebig-University, Giessen, Germany
May 1989	Abitur (High School graduation)
1980-1989	High School at Giengen/Brenz and Viernheim, Germany
1975-1980	Primary and Secondary School in Giengen/Brenz, Germany

## Acknowledgements / Danksagung / Agradecimientos

Nicht nur hiermit, sondern besser und ausgiebiger "im richtigen Leben", möchte ich mich bei allen Personen bedanken, die direkt oder indirekt am Gelingen dieser Arbeit beteiligt waren.

No solo así, pero también con todo mi corazón "en la vida real", quiero dar las gracias a todas las personas, que han hecho posible este trabajo.

Besonderer Dank gilt einem Eltern, ohne deren stetige moralische und finanzielle Unterstützung diese Arbeit nicht existieren würde.

Nuria, tu amor, tu paciencia y tu aguante me han apoyado en todo momento - ¡Pipi...te quiero!

PD Dr. Aria Baniahmad, meinem eigentlichen Lehrmeister, danke ich für all die Zeit und die Nerven die er mir geopfert hat, seine selbstlose Unterstützung, seine Geduld und seinen Humor. Mein Dank wird dir ewig nachkriechen...! Danke auch dafür, dass du an mich geglaubt hat, als ich selbst es nicht getan habe. Aria, es gibt eigentlich keine Worte für das, was du für mich getan hast!!

Anne, thanks for energyshifting!!! Rich, que bien, que eres mi amigo. Lass dir das feiern nicht verbieten.

Ana C. con todo cariño gracias por todo - ¡tu ya sabes!

"Muchas Gracias" también a mis supercompis del labo (y del labo de *alao* también). - ya se que os esperais mas chapa (como de costumbre), pero hoy no voy a ser la mosca cojonera, así que me podeis poner el Caganer (pero no el pelotín). Cada uno de vosotros me ha ayudado a su manera a diario, aunque sea aguantandome. Os debo mucho. Para que veáis, que os quiero un mogollón, os prometo una juerga de las buenas. Y si estais decepcionados por unos agradecimientos tan sosos - leed la frase del final -que dice todo.

Margarita - el alma del labo - gracias por tu cariño, tu ayuda, tus masajitos y tu gran trabajo en el animalario y claro, por el chorizo.

Ana Aranda y Angel Pascual doy las gracias por escucharme tantas veces, cuando yo lo necesitaba. ¡Angel, gracias por la silla verde!

Danke auch der Crew und Ex-Crew von 3.5.1, besonders Uwi (Bier jetzt!), Dorit (Agent Schnalli), Jörg (brabbel), Maren (Schneggi), Frauke (Och, joo!?) und Udo (Schnecken alarm!) dafür, dass ihr mich von Deutschland aus (und auch von anderswo) so oft unterstützt habt. -lets keep in contact!

Gracias también a toda la gente sin nombrar, que me ha ayudado -muchas veces sin saberlo - con una sonrisita, un "hola que tal" o una charlita rápida en la silla verde.

Prof. Dr. Rainer Renkawitz danke ich dafür, dass er mich als Tutor vor dem Fachbereich 08 der Universität Giessen vertreten hat.

A Prof. Alberto Muñoz agradezco, que me haya acogido con paciencia en su laboratorio todo este tiempo y que me haya apoyado en los momentos clave.

Finalmente quiero coger prestado una expresión a un gran amigo mío que me impresionó mucho y que expresa exactamente lo que pienso y siento:

**"Se agradece mucho mejor en persona que en papel"**

... ¡y eso pienso hacer! ...